

6-1997

Laboratory Assessment of Advanced Oxidation Processes for Treatment of Explosives and Chlorinated Solvents in Groundwater from the Former Nebraska Ordnance Plant

Elizabeth C. Fleming

Waterways Experiment Station

Mark E. Zappi

Waterways Experiment Station

Evelyn Toro

Waterways Experiment Station

Rafael Hernandez

Waterways Experiment Station

Karen Myers

Waterways Experiment Station

See next page for additional authors

Follow this and additional works at: <http://digitalcommons.unl.edu/usarmyceomaha>

 Part of the [Civil and Environmental Engineering Commons](#)

Fleming, Elizabeth C.; Zappi, Mark E.; Toro, Evelyn; Hernandez, Rafael; Myers, Karen; Kodukula, Prasad; and Gilbertson, Rosemary, "Laboratory Assessment of Advanced Oxidation Processes for Treatment of Explosives and Chlorinated Solvents in Groundwater from the Former Nebraska Ordnance Plant" (1997). *US Army Corps of Engineers*. 139.
<http://digitalcommons.unl.edu/usarmyceomaha/139>

This Article is brought to you for free and open access by the U.S. Department of Defense at DigitalCommons@University of Nebraska - Lincoln. It has been accepted for inclusion in US Army Corps of Engineers by an authorized administrator of DigitalCommons@University of Nebraska - Lincoln.

Authors

Elizabeth C. Fleming, Mark E. Zappi, Evelyn Toro, Rafael Hernandez, Karen Myers, Prasad Kodukula, and Rosemary Gilbertson

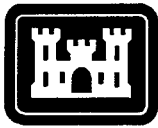

US Army Corps
of Engineers
Waterways Experiment
Station

Technical Report SERDP-97-3
June 1997

Strategic Environmental Research and Development Program

Laboratory Assessment of Advanced Oxidation Processes for Treatment of Explosives and Chlorinated Solvents in Groundwater from the Former Nebraska Ordnance Plant

by *Elizabeth C. Fleming, Mark E. Zappi, Evelyn Toro,
Rafael Hernandez, Karen Myers, WES*

Prasad Kodukula, Woodward-Clyde Consultants, Inc.

Rosemary Gilbertson, Kansas City District

011113 01011300 01011300 01011300 01011300 01011300 01011300
01011300 01011300 01011300 01011300 01011300 01011300 01011300
01011300 01011300 01011300 01011300 01011300 01011300 01011300
01011300 01011300 01011300 01011300 01011300 01011300 01011300
01011300 01011300 01011300 01011300 01011300 01011300 01011300
01011300 01011300 01011300 01011300 01011300 01011300 01011300
01011300 01011300 01011300 01011300 01011300 01011300 01011300
01011300 01011300 01011300 01011300 01011300 01011300 01011300
01011300 01011300 01011300 01011300 01011300 01011300 01011300

Approved For Public Release; Distribution Is Unlimited

19971022 081

QUALITY INSPECTED 3

Prepared for Headquarters, U.S. Army Corps of Engineers
and U.S. Army Engineer District, Kansas City



The contents of this report are not to be used for advertising, publication, or promotional purposes. Citation of trade names does not constitute an official endorsement or approval of the use of such commercial products.

The findings of this report are not to be construed as an official Department of the Army position, unless so designated by other authorized documents.



PRINTED ON RECYCLED PAPER

Laboratory Assessment of Advanced Oxidation Processes for Treatment of Explosives and Chlorinated Solvents in Groundwater from the Former Nebraska Ordnance Plant

by Elizabeth C. Fleming, Mark E. Zappi, Evelyn Toro, Rafael Hernandez, Karen Myers

U.S. Army Corps of Engineers
Waterways Experiment Station
3909 Halls Ferry Road
Vicksburg, MS 39180-6199

Prasad Kodukula

Woodward-Clyde Consultants, Inc.
10975 El Monte, Suite 100
Overland Park, KS 66211

Rosemary Gilbertson

U.S. Army Engineer District, Kansas City
700 Federal Building
Kansas City, MO 64106-2896

Final report

Approved for public release; distribution is unlimited

Prepared for U.S. Army Corps of Engineers
Washington, DC 20314-1000
and U.S. Army Engineer District, Kansas City
Kansas City, MO 64106-2896

DTIC QUALITY INSPECTED 3



**US Army Corps
of Engineers**
Waterways Experiment
Station

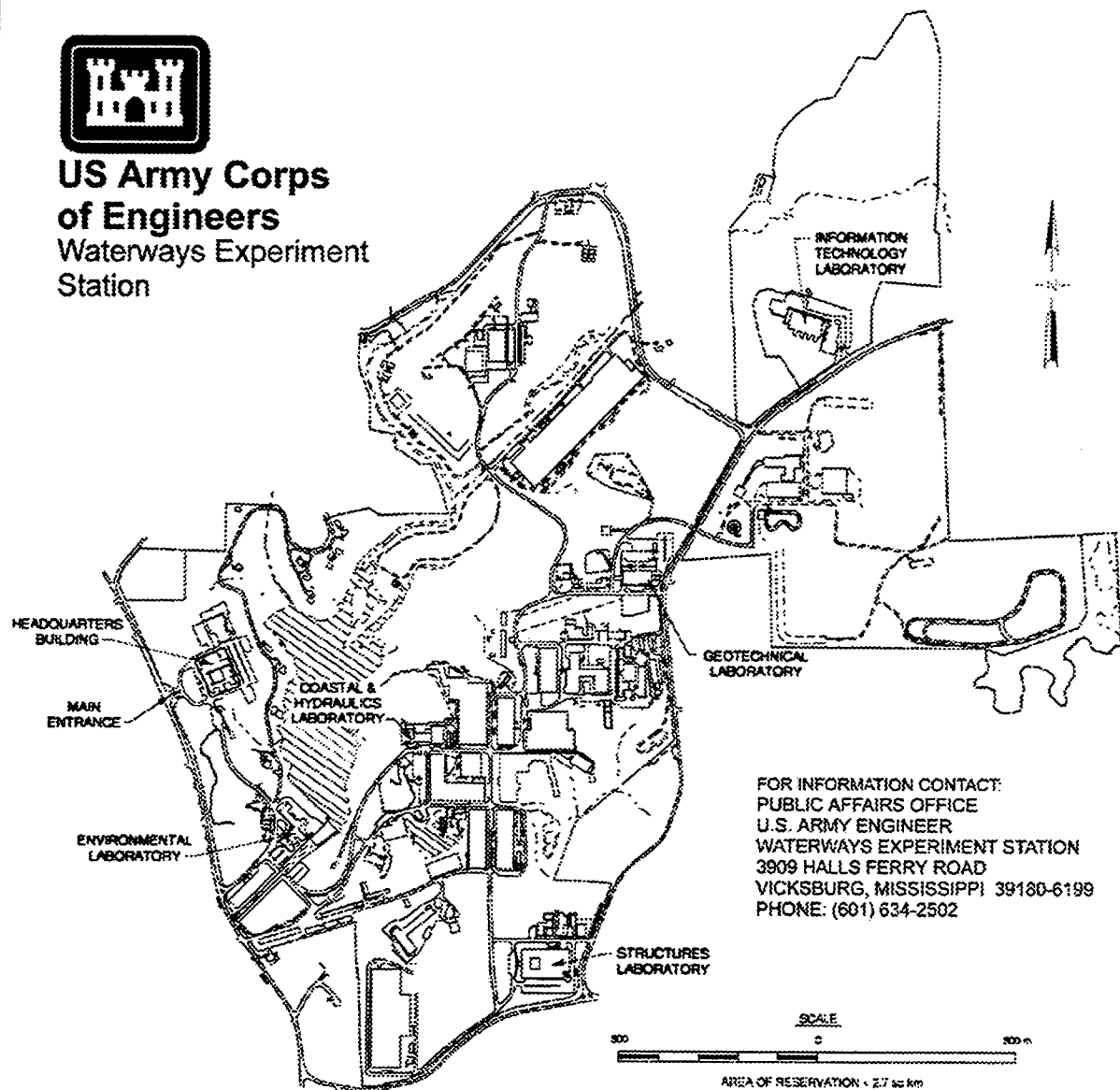

Waterways Experiment Station Cataloging-in-Publication Data

Laboratory assessment of advanced oxidation processes for treatment of explosives and chlorinated solvents in groundwater from the former Nebraska Ordnance Plant / by Elizabeth C. Fleming ... [et al.]; prepared for U.S. Army Corps of Engineers and U.S. Army Engineer District, Kansas City.

66 p. : ill. ; 28 cm. — (Technical report ; SERDP-97-3)

Includes bibliographic references.

1. Groundwater — Pollution — Nebraska — Mead. 2. Oxidation. 3. Explosives, Military — Nebraska — Mead. 4. Hazardous waste site remediation — Nebraska — Mead. I. Fleming, Elizabeth C. II. United States. Army. Corps of Engineers. III. United States. Army. Corps of Engineers. Kansas City District. IV. U.S. Army Engineer Waterways Experiment Station. V. Strategic Environmental Research and Development Program (U.S.) VI. Series: Technical report (U.S. Army Engineer Waterways Experiment Station) ; SERDP-97-3.

TA7 W34 no.SERDP-97-3

Contents

Preface	v
Conversion Factors, Non-SI to SI Units of Measurement	vii
1—Introduction	1
Site Background	1
Advanced Oxidation Processes	2
Study Objectives	10
2—Experimental Methods	11
Materials	11
Methods	13
3—Results	17
TCE	17
RDX	18
HMX	19
TNT/TNB	20
4—Engineering Significance	26
5—Conclusions	28
References	29
Appendix A: Raw Analytical Data	A1
Appendix B: Peroxone Pilot Study Paper	B1
SF 298	

List of Tables

Table 1. Chemical Analysis of the NOP Composite Groundwater Sample and Target Treatment Goals	11
Table 2. AOP and Respective Treatment Conditions Evaluated	13
Table 3. TCE Removal from NOP Groundwater	18

Table 4.	RDX Removal from NOP Groundwater	19
Table 5.	HMX Removal from NOP Groundwater	20
Table 6.	2A-DNT Removal from NOP Groundwater	21
Table 7.	4A-DNT Removal from NOP Groundwater	22
Table 8.	Summary of Treatment Effectiveness	24

Preface

The study herein was performed through a partnering effort between the U.S. Army Engineer District, Kansas City, Kansas City, MO, and the U.S. Army Engineer Waterways Experiment Station (WES), Vicksburg, MS. The Kansas City District funded portions of this effort as a means of evaluating various treatment options for the contaminated groundwaters at the Nebraska Army Ammunition Plant, Mead, NE.

Some of the WES activities were performed under funding from the U.S. Department of Defense's (DoD) Strategic Environmental Research and Development Program (SERDP). WES has been tasked by SERDP to develop peroxone oxidation as an economical means of decontaminating groundwaters contaminated with explosives at DoD sites.

This report was prepared by Ms. Elizabeth C. Fleming, Dr. Mark E. Zappi, Ms. Evelyn Toro, and Mr. Rafael Hernandez, all of the Environmental Restoration Branch (ERB), Environmental Engineering Division (EED), Environmental Laboratory (EL), WES; Ms. Karen Myers, Environmental Chemistry Branch (ECB), EED; Dr. Prasad Kodukula, Woodward-Clyde Consultants, Inc., Overland Park, KS; and Ms. Rosemary Gilbertson, Kansas City District.

This study was performed at WES under the direct supervision of Mr. Daniel E. Averett, Chief, ERB, and under the general supervision of Mr. Norman R. Francingues, Jr., Chief, EED. Drs. John W. Keeley and John Harrison were the Assistant Director and Director of EL, respectively, during this study.

Dr. Harrison was also the Director of SERDP, Washington, DC, and Dr. M. John Cullinane was the WES Program Manager of SERDP during this study.

At the time of publication of this report, Dr. Robert W. Whalin was the Director of WES. COL Bruce K. Howard, EN, was Commander.

This report should be cited as follows:

Fleming, E. C., Zappi, M. E., Toro, E., Hernandez, R., Myers, K., Kodukula, P., and Gilbertson, R. (1997). "Laboratory assessment of advanced oxidation processes for treatment of explosives and chlorinated solvents in groundwater from the former Nebraska Ordnance Plant," Technical Report SERDP-97-3, U.S. Army Engineer Waterways Experiment Station, Vicksburg, MS.

The contents of this report are not to be used for advertising, publication, or promotional purposes. Citation of trade names does not constitute an official endorsement or approval of the use of such commercial products.

Conversion Factors, Non-SI to SI Units of Measurement

Non-SI units of measurement used in this report can be converted to SI units as follows:

Multiply	By	To Obtain
acres	4,046.873	square meters
gallons (U.S. liquid)	3.785412	liters
miles (U.S. statute)	1.609347	kilometers

1 Introduction

Site Background

The former Nebraska Ordnance Plant (NOP) is located in Mead, NE (approximately 20 miles¹ southwest of Omaha). The site is a former explosives manufacturing and assembling facility of the U.S. Army. The facility has operated intermittently since 1942 to support both World War II and Korean War efforts. Various Department of Defense entities have used the facility for training and testing operations. During 1990, the site was placed on the National Priorities List.

Past military-related activities at the NOP have resulted in the contamination of the groundwater with low levels of explosives and chlorinated solvents. The U.S. Army Engineer District, Kansas City, is performing cleanup activities at the NOP. Woodward-Clyde Consultants, Overland Park, KS, is assisting the Kansas City District with these activities under a task order contract. Both the Corps of Engineers and Woodward-Clyde are currently investigating various treatment technologies for the contaminated groundwaters at the site. Technologies under investigation include activated carbon adsorption and advanced oxidation processes (AOPs).

The U.S. Army Engineer Waterways Experiment Station (WES), Vicksburg, MS, under direction of the Kansas City District and in conjunction with Woodward-Clyde evaluated several AOPs for treatment of groundwater from the NOP using bench-scale reactors. This report summarizes the results of these efforts. Candidate AOPs that were evaluated were irradiation of hydrogen peroxide with ultraviolet (UV) light emitted from low-pressure mercury vapor UV lamps (LPUV-HP), irradiation with UV light emitted from a low-pressure mercury vapor UV lamp with ozone sparging (LPUV-OZ), irradiation of hydrogen peroxide with UV light emitted from a medium-pressure mercury vapor UV lamp (MPUV-HP), and peroxone (ozone sparging with hydrogen peroxide dosing).

¹ A table of factors for converting non-SI units of measurement to SI units is presented on page vii.

Advanced Oxidation Processes

Chemical oxidation is a treatment technology that uses powerful chemical oxidizers to destroy organic contaminants. Typical oxidizers used in chemical oxidation processes include ozone, chlorine, hydrogen peroxide, and potassium permanganate. The chemical reaction products are usually simple organic compounds, such as carboxylic acids, and/or inorganic compounds, such as carbon dioxide, water, and chlorides, which is the case with the oxidation of chloroform.

The technology has historically been used as a treatment technology for municipal drinking water (Metcalf and Eddy, Inc. 1991). Chlorination has been used almost extensively in the United States for disinfection of municipal drinking water (James Montgomery Engineers, Inc. 1985). Chemical oxidation has been used primarily with UV photolysis for contaminated site remediation and industrial wastewater treatment. Hydrogen peroxide (H_2O_2) and ozone (O_3) have generally been used in conjunction with UV photolysis with respect to groundwater remediation projects. Mayer et al. (1990) concluded that chemical oxidation processes are very competitive with both air stripping and activated carbon adsorption for treating volatile organic compound (VOCs) in contaminated groundwaters.

Chemical oxidation processes that result in the generation of the hydroxyl radical (OH^\cdot) have been referred to as AOPs by the American Water Works Association (1991). Commercial application of AOPs for contaminated groundwater treatment in the United States has traditionally involved UV irradiation of hydrogen peroxide, ozone, or a combination of both.

There are many different oxidation processes that may be considered an AOP. Examples include electron beam irradiation, supercritical oxidation, irradiation of oxidizers with UV light (all of the AOPs evaluated during this study, except peroxone, fall into this category), peroxone, sonozone, and irradiation of semiconductors. Technically, these AOPs should provide sufficient treatment; however, when process economics and the potential for near-term field implementation are also considered, many of those processes become cost prohibitive for treating low levels of explosives and VOCs such as those found in the NOP groundwater.

UV/hydrogen peroxide

The addition of UV light to an aqueous solution of H_2O_2 or O_3 results in the generation of hydroxyl radicals. The hydroxyl radical is a much more powerful oxidizer than either H_2O_2 or O_3 (Sundstrom et al. 1986).

The absorbance of UV light by both hydrogen peroxide and ozone varies greatly. Ozone absorption of UV light occurs primarily at 254 nm (2,540 angstrom units), while hydrogen peroxide absorbs wavelengths of approximately 230 nm and lower. The low-pressure (LP) mercury UV lamp, commonly used in water treatment for

disinfection, emits its radiation spectrum almost exclusively at the 253.9-nm wavelength. The medium-pressure UV lamp emits the majority of its radiation spectrum over a wide band from approximately 190 to 600 nm, with a large portion of energy centered around the 200- to 300-nm range. Chemical oxidation systems using ozone are better served using LPUV lamps. These lamps are more efficient and produce the exact UV spectrum that is readily usable by ozone for production of OH radicals.

Medium-pressure UV (MPUV) lamps are much more energy intensive than LPUV lamps. Much of the electrical energy used by the MPUV lamp is wasted as heat radiation. However, chemical oxidation systems using hydrogen peroxide are better served with MPUV lamps that emit more UV energy in the absorbance band of the hydrogen peroxide, thereby, resulting in optimal OH• radical production. Although MPUV lamps are more energy intensive, some benefit may be derived by using an MPUV lamp for treatment of some organic contaminants because of direct photolysis of the contaminants by UV absorption. Many organic compounds absorb at lower UV wavelengths (i.e., <230 nm), making the direct absorption of UV energy from an LPUV lamp of little benefit toward direct photolysis. However, in UV-based chemical oxidation systems, it is usually more advantageous to convert the parent chemical oxidizers (O₃ and H₂O₂) into hydroxyl radicals with the UV energy unless the rate of contaminant degradation under direct photolysis is rapid. An optimal UV/chemical oxidizer system should be selected and designed on the basis of the photochemical properties of the contaminant(s) and oxidizer and the physical, chemical, and optical properties of the influent water.

The stoichiometric mechanism responsible for generation of hydroxyl radicals in UV/hydrogen peroxide systems as proposed by Sundstrom et al. (1986) is presented below:

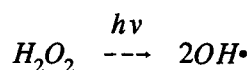

Oxidation of liquid phase contaminants using UV and hydrogen peroxide is commonly referred to as UV/peroxidation. This technology has been successfully used for treatment of several contaminated waters containing a variety of organic contaminants (Zappi et al. 1990; Froelich 1992; Zappi, Fleming, and Cullinane 1992).

Sundstrom et al. (1986) evaluated the feasibility of using UV/hydrogen peroxide-based systems for treatment of a variety of VOCs including chloroform. They concluded that the rate of trichloroethylene (TCE) removal increases as the hydrogen peroxide dose increases. Increased rate with increasing oxidizer dose is probably due to increased radical production rates. They also conclude that photolysis alone was responsible for removal of some of the VOCs. Direct photolysis of chloroform and tetrachloroethane was nearly as effective as the AOP process. These studies were performed using LPUV lamps with hydrogen peroxide. Use of MPUV lamps would probably have increased the reaction rate by increasing

the hydrogen peroxide absorption of the photons emitted at the lower UV wavelengths produced by the MPUV lamps (i.e., <254 nm).

Sundstrom, Weir, and Klei (1989) also used LPUV lamps with hydrogen peroxide to treat a variety of aromatic compounds. They concluded that by increasing the hydrogen peroxide concentration, they could also increase the reaction rate. As discussed for the previous study, higher quantum yields than those achieved in their bench reactors may have been realized using MPUV lamps instead of the LPUV lamps used because of the relatively low absorbance of UV energy by hydrogen peroxide at the 254-nm wavelength. Reduced costs may be realized by using the LPUV lamp instead of the MPUV lamp; however, using LPUV lamps may require more hydrogen peroxide, thereby, adversely impacting costs.

Hager, Lovern, and Giggy (1987) presented several case studies where a commercial UV/hydrogen peroxide-based system successfully treated a variety of contaminants. They suggest the costs for treatment would range from \$1.37 to \$58.51 per 1,000 gal treated.

DeBerry, Viehbeck, and Meldrum (1984) evaluated a host of AOPs for oxidation of trinitrotoluene (TNT) (pink water) and 1,3,5-trinitrobenzene (TNB), a known intermediate of incomplete TNT oxidation. They primarily focused on UV/ozone and UV/hydrogen peroxide oxidation systems; however, both Fenton's reagent and peroxone were briefly evaluated. They concluded that the two UV-based AOPs were effective, while the Fenton's reagent and peroxone indicated promise for treating low-level contaminated waters. They suggested that additional investigation into the peroxone process is required to establish further process feasibility.

UV/ozone

Burrows (1983) indicated that ozonation alone was a poor means for TNT removal. He concluded that the addition of UV to the ozonation reactor yielded removals in excess of 90 percent for TNT within 30 min of batch treatment from a wastewater initially containing $>18,000$ $\mu\text{g}/\ell$ TNT. Burrows noted that 2,4,6-trinitrobenzoic acid appears to be a potential intermediate of TNT oxidation based on gas chromatography/mass spectrometry (GC/MS) analysis. A first order rate constant of 0.051 min^{-1} for TNT removal was reported by Burrows (1983).

Peyton, Michelle, and Peyton (1987) present a mechanism for $\text{OH}\cdot$ generation during UV irradiation of ozone. This mechanism is summarized below:

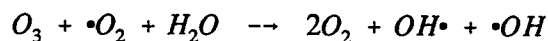
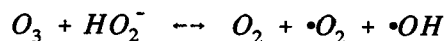
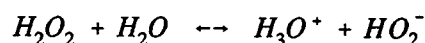
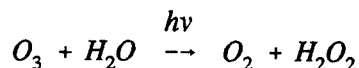

Jody, Klein, and Judeikis (1989) used UV/ozone to treat wastewater contaminated with hydrazine compounds. They concluded that UV/ozonation with the addition of tungsten catalyst was the most optimal system evaluated. The UV/ozone/ tungsten system had a slightly slower kinetic rate than other systems evaluated; however, this system produced an effluent with fewer intermediates (e.g., n-nitrosodimethylamine [NDMA], which is a proven animal carcinogen).

Barich and Zeff (1989) list a variety of contaminated groundwaters and wastewaters that were successfully treated using a commercially available UV/ozone system. They indicate that treatment costs range from \$0.15 to \$86.00 per 1,000 gal treated.

Fochtman and Huff (1975) evaluated ozonation under UV irradiation produced by a low-pressure mercury vapor UV lamp. The test influent used in this study was a synthetic pink water solution containing approximately 100 mg/l of TNT. Their results indicated that ozonation alone was not effective for TNT removal (based on total organic carbon removal); however, photolysis of the ozonated solution was quite effective by reducing total organic carbon from 53 to 28 mg/l within 45 min of batch treatment. They performed an organic carbon mass balance analysis using a gravimetric technique for estimating carbon dioxide mass captured from the sparged reactor. Their results suggest that over 85 percent of the TNT carbon atoms were oxidized to carbon dioxide, implying a high degree of mineralization.

Layne et al. (1982) evaluated LPUV/ozone for treatment of pink water from an Army facility using a commercially available pilot-scale system. Their results indicated that meeting a TNT effluent concentration of 1,000 µg/l was easily obtainable; however, the process costs approximately twice as much as activated carbon. They noted that as treatment levels are reduced to lower limits, the technology will become much more cost competitive with activated carbon due to carbons reduced efficiency as target levels decrease.

Zappi, Hong, and Cerar (1993) evaluated a variety of AOPs for treatment of explosives-contaminated groundwaters. AOPs evaluated included ozonation with low-pressure mercury vapor UV lamp-based photolysis, medium-pressure mercury vapor UV lamp-based photolysis with hydrogen peroxide dosing, low-pressure mercury vapor UV lamp-based photolysis with hydrogen peroxide dosing, ozonation with medium-pressure mercury vapor UV lamp-based photolysis and hydrogen peroxide dosing, and perozone. The groundwater contained approximately 30,000 µg/l TNT, 32,000 µg/l RDX, 2,000 µg/l HMX, and

1,500 µg/l TNB. Their results indicated that only the UV/ozone-based AOPs were capable of removing all of the explosives and TNB to the current treatment standard of 2 µg/l for TNT, RDX, and TNB and 400 µg/l for HMX. Peroxone did result in explosives removals in excess of 90 percent, yet it was not successful in meeting the 2-µg/l TNB standard after 60 min of batch treatment. The UV-based hydrogen peroxide-dosed systems yielded mixed results. The medium-pressure lamps with hydrogen peroxide removed all of the explosives, but was unsuccessful in meeting the TNB standard. The low-pressure mercury UV-based system with hydrogen peroxide addition was the least aggressive of all those tested.

Ozone/hydrogen peroxide (peroxone)

Peroxone is an AOP that uses the combination of hydrogen peroxide and ozone to form the hydroxyl radical without use of UV light. The results reported by Glaze and Kang (1988) indicated that peroxone could effectively remove chlorinated solvents from the groundwater. Since peroxone does not require the addition of high concentrations of chemical oxidizers and UV light, it is estimated that reductions in treatment costs as high as 50 percent may be realized. Langlais, Reckhow, and Brink (1991) present the following mechanism for the formation of the hydroxyl radical during peroxone treatment:

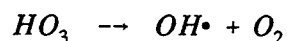
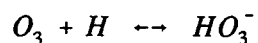
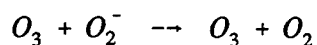
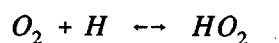
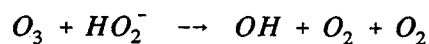

Discussions with French researchers indicate that some water utilities in France are currently using peroxone to treat millions of gallons per day of pesticide-contaminated groundwater.¹ The French researchers claim that treatment costs are on the order of \$0.05 per 1,000 gal treated.

Glaze and Kang (1988) performed laboratory-scale studies on the ability of peroxone to remove trichloroethylene (TCE) and tetrachloroethylene from a contaminated groundwater. The results proved positive enough to warrant subsequent pilot-scale evaluations (Aieta et al. 1988). Both the bench and pilot studies concluded that the reaction rates of TCE and PCE were increased by factors

¹ Personal Communication, 1992, Dr. Marcel Dore, University of Poitiers, France.

of 1.8 to 2.8 and 2.0 to 6.5, respectively, as opposed to those achieved by ozonation alone. Apparently, TCE was reactive toward ozone alone as well as the hydroxyl radicals formed; PCE was only reactive toward the radical species. Both studies indicated that a hydrogen peroxide-to-ozone ratio between 0.25 and 0.5 was optimal for removing TCE and PCE from the groundwater studied.

The Metropolitan Water District of Southern California (1991) evaluated peroxone using pilot-scale systems for treatment of 2-methylisobornel (MIB) and trans-1,10-dimethyl-trans-9-decanol (geosmin). The District concluded that optimum hydrogen peroxide-to-ozone ratios for removal of MIB and geosmin was 0.1 to 0.2. They further conclude that peroxone was better for removal of MIB and geosmin than ozone alone due to increased hydroxyl radical production.

The addition of UV is not always required. The addition of UV light in chemical oxidation systems usually accounts for 20-90 percent of treatment costs. Eliminating the addition of UV could potentially reduce treatment costs by this percentage range. There are several catalysts that may be used to increase the reaction rate between a chemical oxidizer and contaminant(s). The reaction rates obtainable may be rapid enough to make chemical oxidation without UV feasible from both a technical and economic standpoint. One major drawback of UV/chemical oxidation systems is the scumming of the quartz tubes housing the UV lights with oxidized iron and manganese. Once the tubes become fouled up with scum, UV irradiation transmittance through the tubes can become severely limited. Treatment of contaminated water containing these cations (i.e., groundwaters) using chemical oxidation without UV light eliminates the problem of quartz tube scumming. If the scumming of the UV quartz tubes becomes a problem, then the addition of a cation removal system may be required. However, recent advances in UV/chemical oxidizer reactor design have incorporated cleaning devices for the quartz tubes housing the UV lamps. The concept of UV tube cleaning systems is not new; cleaning systems have been successfully used for years by the water treatment industry.

Zappi et al. (1994) evaluated peroxone as a treatment technique for TNT contaminated waters. His experiments compared the extent of TNT and TNB removal achieved from the more traditional UV-based AOPs to those obtained using peroxone with and without ultrasonic catalyzation. The results indicated that the peroxone systems are comparative to the UV-based AOPs in terms of both rate and extent of removal. Zappi suggests that the potential reduction in capital and operational and maintenance (O&M) costs due to peroxone not requiring UV lamps is especially promising. A steady-state hydroxyl radical model was proposed and evaluated for a range of hydrogen peroxide-to-ozone (H/O) ratios. The model predicted that a point of diminishing returns is met after an H/O ratio of approximately 2.5 is exceeded. A 10-mg/l hydrogen peroxide, 30.68-mg O₃/min peroxone system was the most efficient peroxone system evaluated.

Zappi et al. (1994) also concluded that adding ultrasound and increasing pH in the reactors had the most dramatic positive impact on the ozonation system. These adjustments converted ozonation from a system achieving slow TNT removal rates to one of the most rapid TNT degradation systems evaluated. Some benefit was

found in that similar TNT and TNB removal rates could be obtained by decreasing hydrogen peroxide from 100 to 10 mg/l and adding 24 W of ultrasonic power. Another significant conclusion made was that hydrogen peroxide should be continuously added to the peroxone system to maintain the system H/O ratio at an optimum. The optimal H/O ratios determined from this study appear to be in the 0.4 to 1.3 range, which is slightly higher than those suggested in literature. This approach will make design of the peroxone system slightly more complicated; however, the technical and economic benefits of continuously adding hydrogen peroxide could be significant. Also, the economic benefit of replacing higher doses of hydrogen peroxide with lower doses along with ultrasonic catalyzation should be further investigated.

Hydroxyl radical formation kinetics

To further understand some of the results presented in this report, a brief description on key hydroxyl radical reaction mechanisms is presented. Researchers at WES have recently published a numerical model for estimating the steady-state hydroxyl radical concentrations in various AOPs (Hong, Zappi, and Kuo 1994). The key mechanistic pathways for production and reaction with hydroxyl radicals are illustrated in Figure 1. From Figure 1, it can be seen that there are numerous chemical reactions that may occur that produce and subsequently remove radical species from an AOP reactor. Radical production mechanisms include photolytic, pH, and ozone-hydrogen peroxide reactions. Radical degradation or scavenging reactions include contaminant, inorganic constituent, and parent oxidizer reactions. Only those reactions that result in the destruction of the contaminant are considered beneficial. The other reactions usually have an adverse impact on reaction kinetics due to the scavenging of radicals that would have been available for contaminant destructive reactions. WES identified three predominant scavenging reactions that will likely occur within traditional AOP reactor systems. These are reactions with bicarbonate/ carbonate ions, reduced cations (i.e., iron), and excessive amounts of primary oxidizers (i.e., ozone and hydrogen peroxide). Of key interest is that too much hydrogen peroxide or ozone may be added to an AOP system. Usually obtaining excessive amounts of ozone is difficult because ozonation is mass transfer limited (gas to water transfer). However, introduction of hydrogen peroxide (a liquid) is much easier and is likely a potential scavenging source in AOPs. There is an optimum dose for each oxidizer and optimum stoichiometric mass-to-mass ratios for those AOPs using both oxidizers, such as peroxone. Some of the data presented in this report serve as excellent examples of these mechanisms.

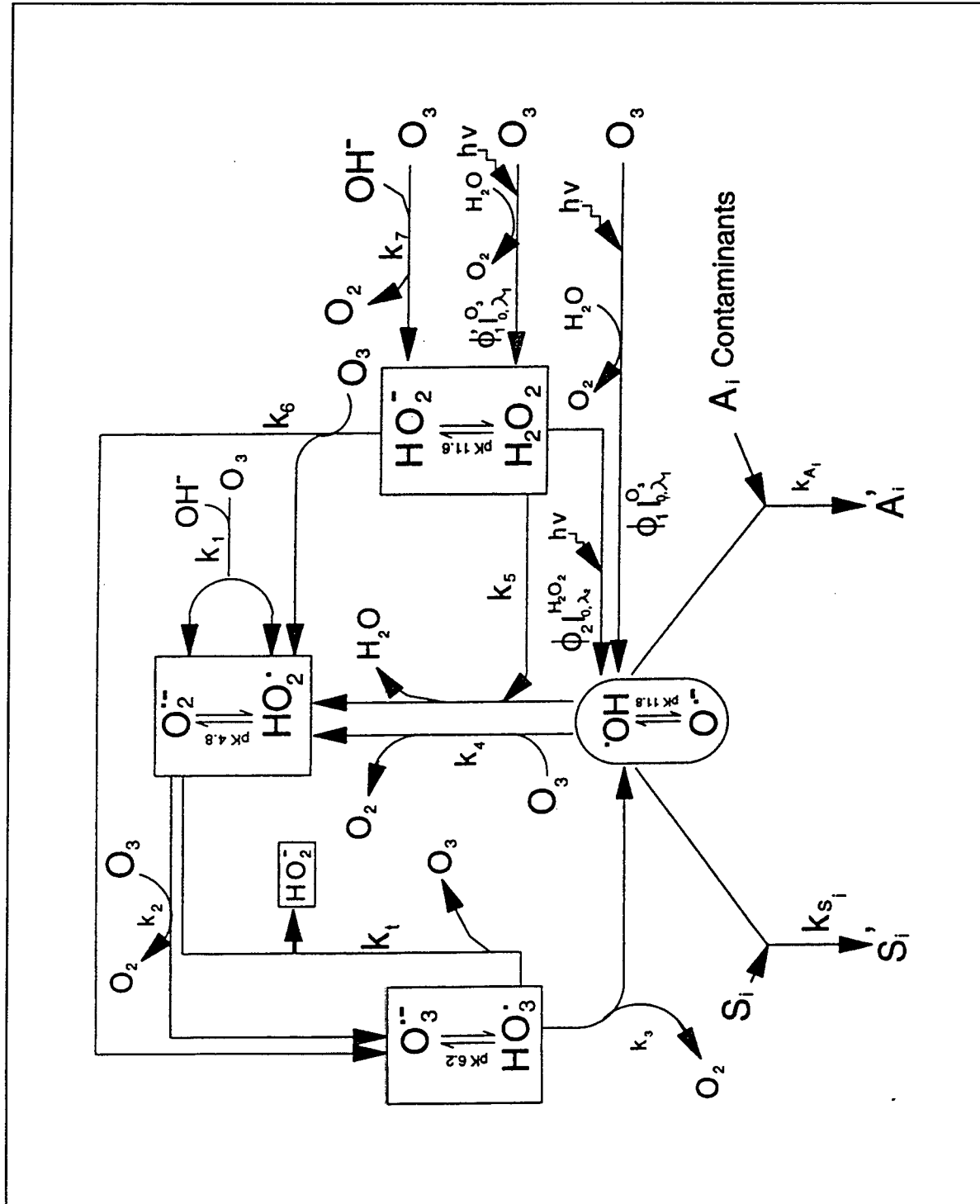

Figure 1. Hydroxyl radical formation/scavenging mechanisms during AOP treatment (Hong, Zappi, and Kuo 1996)

Study Objectives

The primary objective of this study was to evaluate the comparative performance of the four candidate AOPs for removing TCE, RDX, HMX, TNT, and TNB from a representative sample of the NOP groundwater. Secondary objectives included the following:

- a.* Evaluate if innovative processes such as peroxone and LPUV/hydrogen peroxide were competitive with the more established AOPs in terms of meeting target treatment goals.
- b.* Provide Woodward-Clyde with design information concerning each AOP for evaluation of engineering feasibility.
- c.* Provide performance information for planning a potential onsite pilot-scale effort.

2 Experimental Methods

Materials

The groundwater influent sample used in this study was a three-way composite (equal parts) of groundwater collected from three site observation wells (Wells MW-11A, MW-40B, and MW-47B). Samples were collected by Woodward-Clyde during November 1994 and transported to WES in two 55-gal drums by WES employees. Upon receipt at WES, the two samples were mixed at a 50/50 mix to formulate the test influent used during this study. Table 1 lists the resulting contaminant concentrations and the targeted treatment goals selected for this study. The composite samples were stored at 4 °C until testing.

Analyte	Concentration, mg/ℓ	Target Treatment Goal, mg/ℓ
TCE	0.697	0.005
RDX	0.0128	0.002
HMX	0.0028	0.400
TNT	0.0001	0.0002
TNB	0	0.0002
2A-DNT	0.0003	NI
4A-DNT	0.0007	NI

Note: NI = No target treatment goal identified.

Figure 2 presents an illustration of the AOP reactor units used in this study. The outer shell of the reactors are constructed of borosilicate glass with the inner immersion well, which houses the UV lamps, being constructed of quartz glass. Quartz glass is required because most glass types or plastic materials cannot transmit UV photons. The immersion well is jacketed to control the temperature

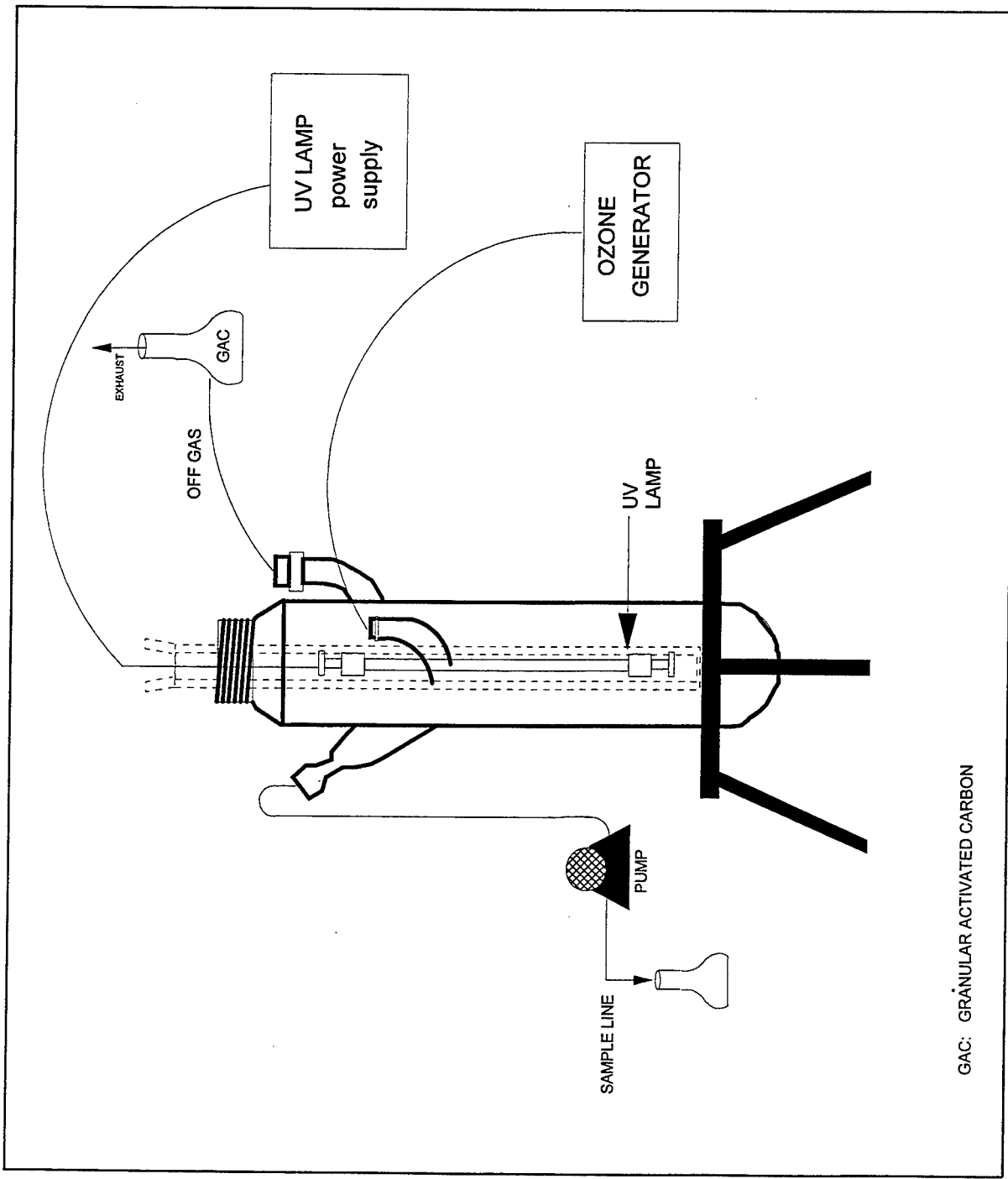

GAC: GRANULAR ACTIVATED CARBON

Figure 2. WES bench-scale AOP reactor

of the UV lamps, which can produce significant heat (especially the MPUV lamps). Cooling was accomplished by circulation of chilled water through the cooling jacket. The working (wetted) volume of each reactor is 1 l. Two UV light sources were used in this study; a 200-W, medium-pressure mercury vapor UV lamp and a 12-W, low-pressure mercury vapor UV lamp. Both lamps were manufactured by Hanovia, Inc., and marketed by Ace Glass, Inc. The spectral characteristics of the 200-W MPUV lamps used in this study in the far and middle UV band (220 to 320 nm) were 30.2 W. The LPUV lamp 254-nm energy output was 3.5 W.

Ozone was sparged at a rate of 2.5 standard cubic feet per hour (scfh) into the reactor using an Ozotec ozone generator with turn-down capability to control the percent ozone composition (w/w) of the sparged gas. A 50-percent (w/w) analytical grade hydrogen peroxide stock solution was used to dose the AOP reactor according to the target process formulation.

Methods

Reactor operation

Table 2 lists the various process formulations evaluated during this study. Each of these experiments were performed in duplicate runs.

Table 2 AOP and Respective Treatment Conditions Evaluated			
Candidate AOP	Light Source	Hydrogen Peroxide Dose, mg/l	Ozone Dose, Percent O₃ in Air
MPUV/HP	200 W MPUV	100	NA
LPUV/OZ	12 W LPUV	NA	2
LPUV/HP	12 W LPUV	100	NA
Peroxone	NA	10	2
Peroxone	NA	100	2

Note: MPUV = Medium-pressure Hg vapor UV lamp; LPUV = Low-pressure Hg vapor UV lamp; OZ = Ozone; NA = None applied.

At the initiation of each experiment, the groundwater dosed with hydrogen peroxide (when peroxide was used) was poured into the reactor at a working volume of 1 l. For the UV-irradiated runs, initial time ($t = 0$) was marked when the groundwater with hydrogen peroxide was added to the reactor only after the UV lamp was allowed to come to full radiance. For the ozonated experiments, ozone was sparged into the reactor continuously, while the hydrogen peroxide was batch added with the groundwater. This means that the reactor system was operated in semibatch mode. When ozone and UV were both added, the lamp was allowed to come to full radiance and ozone sparged into the reactor before initial time was

marked. When ozone was used without UV, initial time was marked when ozone sparging was initiated into the hydrogen peroxide-dosed groundwater.

During most of the experiments, samples were collected at test times of 3, 5, 10, 20, 30, and 60 min of treatment. The samples were collected in precleaned sample bottles. The volatile organics and explosives were collected in 40-ml volatile organic analysis (VOA) vials and 1-ℓ bottles, respectively. Small quantities (<0.5 g) of bovine catalase were added to sample vials to remove residual oxidizer species from the sample vial to prevent further oxidation of the contaminants beyond the representative sampling times intended. Since the analytical method for explosives required 1 ℓ of sample and the reactor volume was 1 ℓ, each sampling event was performed individually. That is, each sampling event represents a separate experimental run. Therefore, each experimental series with the six samples collected (3 to 60 min) indicates that six separate runs were performed.

Temperatures were monitored using Fisher brand thermometers immersed into the reactors via a sampling port fitted with an O-ringed compression fitting. Reactor pH was periodically monitored by analysis of the collected samples using a Beckman pH meter with a combination electrode that was calibrated using a standard two-point calibration (buffers of 4 and 10). Reactor temperatures were maintained at operating temperature ranges of 25 to 30 °C. The reactor pH initially started at approximately 6.9, then increased to approximately 8.0 for the ozonated runs. The runs without ozonation did not exhibit an increase in pH. The reason for the slight increase in pH during the ozonated runs was believed to be due to ozone-induced reaction of the free hydronium ions with carbonates. Appendix A lists the reactor temperatures and pH values for each experimental run.

Chemical methods

The VOC analyses were run on a Hewlett-Packard MS/GC with a purge and trap system manufactured by O. I. Analytical using U.S. Environmental Protection Agency (USEPA) Method No. 8240. USEPA required sample holding times were not exceeded during this study. Explosives analyses were performed using USEPA Method 8330 using a Waters brand high performance liquid chromatography unit operated with solid-phase preconcentration procedures. The detection limits for TCE and explosives using these analytical procedures were 0.5 and 0.2 µg/ℓ, respectively.

An HNU brand photoionizer detector (PID) was used to analyze the off-gases exiting various AOP systems to quantify the amount of VOCs stripped from the reactor during ozonation. This technique is capable of analyzing VOC levels as low as 0.1 ppm. Figure 3 illustrates the experimental setup used for off-gas analyses. The process off-gases were passed through two potassium iodide (KI) traps to remove excess ozone. After removal of the ozone, the gases were passed through the PID and the levels recorded. Ozone removal was required because the UV detector used in the PID is sensitive to ozone.

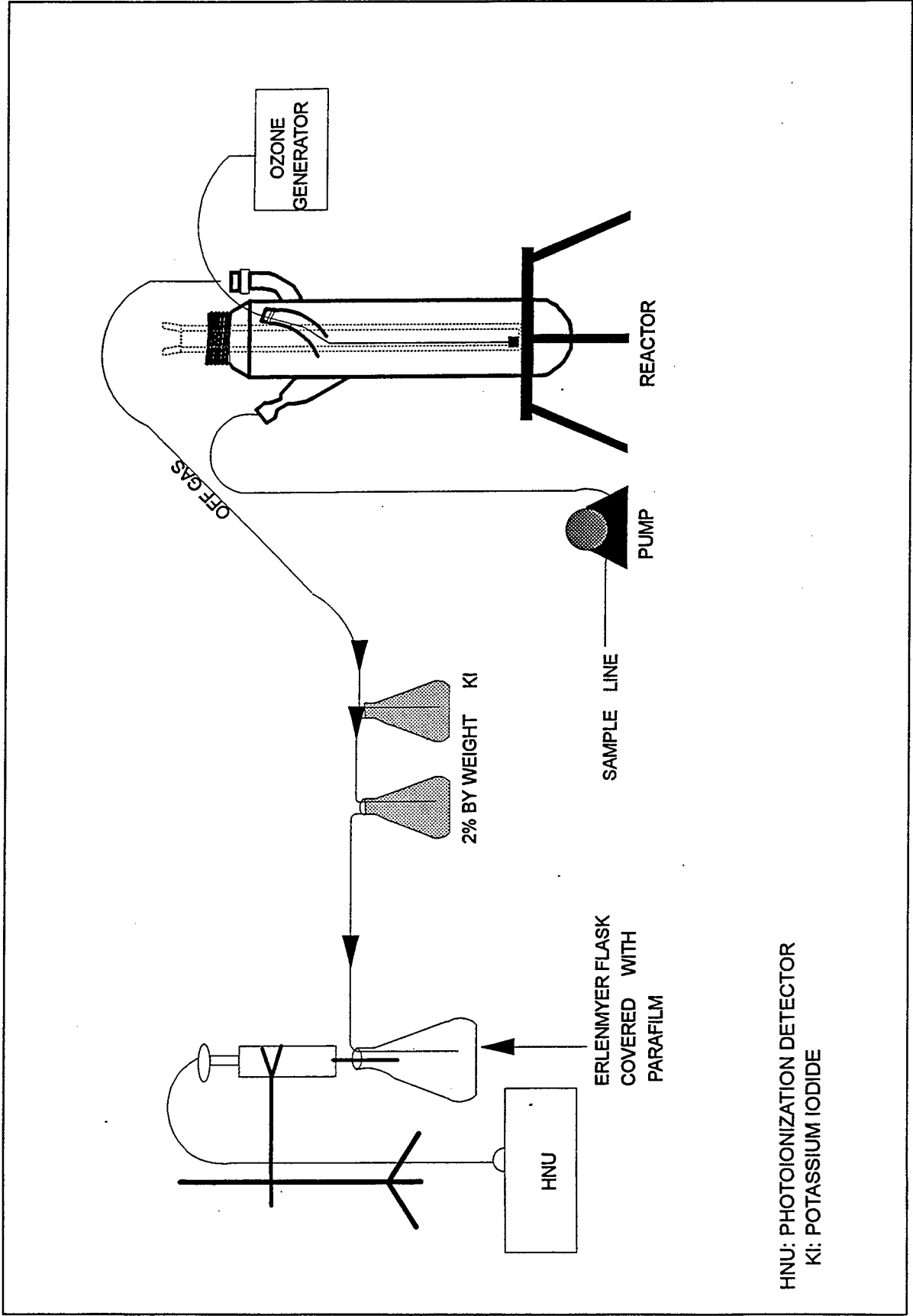

Figure 3. Off-gas analysis setup using a PID

Five individual experiments were performed using the PID setup. Each experiment used the same sparge gas flow rate, which was also the same flow rate (2.5 cfh) used in the actual runs involving the site groundwater. The five experiments performed were as follows:

- a.* Distilled, deionized (DDI) water with aeration (no ozone) - This experiment was performed to quantify the amount of water vapors being analyzed by the PID as total organic carbon (TOC).
- b.* NOP groundwater with aeration - This experiment was used to quantify the full extent of volatilization possible with the NOP groundwater composite used in this study.
- c.* DDI with a 100-mg/l hydrogen peroxide-dosed peroxone system - This experiment quantified the effectiveness of the KI traps to remove oxidizers from the gas stream prior to entering the PID. Comparing these results to the DDI/aeration study (Bullet "a") allows for a quantitation of oxidizer input by subtracting DDI/aeration data set from the data generated from this experiment.
- d.* NOP groundwater with a 100-mg/l hydrogen peroxide-dosed peroxone system - This experiment allows for quantification of the extent of VOC stripping from a peroxone system.
- e.* NOP groundwater with an LPUV/ozone system - This experiment allows for estimation of the VOC removal in an LPUV/ozone system attributable to stripping.

3 Results

The results of this study are presented and discussed on an individual contaminant basis. Process effectiveness is evaluated based on the ability of the AOP to meet the target treatment goals listed in Table 1. The data discussed in the body of this report are presented using tables of test time or hydraulic retention time (HRT) versus the averaged contaminant concentration for each contaminant. The results of each duplicate run (and the respective averages used in generating Tables 3-8) are presented as Appendix A. The averages are shown in the tables for the experiment where one of the two replicates had detectable hits while the other replicate was calculated by assigning the less than detect data a numerical value of half of the detection limit shown. For example, a detection limit of 5 ppb was given a 2.5-ppb value for use in calculating the average. If neither of the two replicates had measurable amounts of contaminant, then the average was given a less than detect label. Concentration values that were measurable, yet were lower than the allowable method quantitation value, were still used in the calculation of the average by giving these numbers the exact value estimated by the analyst. This approach allows for better evaluation of the data, especially when comparing results that are very similar.

TCE

Table 3 presents the TCE removal data for the various AOPs evaluated. These data indicate that TCE was easily removed by all of the AOPs tested. This observation is not surprising since it is well documented on the relative ease of removing TCE using AOPs (see Chapter 1). Target treatment goals were met within 3 min of each ozone-based AOP and within 20 min of each hydrogen peroxide-based AOP.

The LPUV/hydrogen peroxide appears to have achieved conditions to provide slightly better removal of TCE than did the MPUV/hydrogen peroxide system. This is surprising since the MPUV systems are usually much more effective than the LPUV systems for hydrogen peroxide because of improved quantum yields associated with the UV absorption characteristics of hydrogen peroxide (see Chapter 1). However, as stated above, both systems did remove TCE down to target levels within 20 min of treatment.

Test Time min	Contaminant Concentrations, mg/l				
	MPUV/ 100 HP	LPUV/ Ozone	LPUV/ 100 HP	Peroxone (10 HP)	Peroxone (100 HP)
0	0.695	0.690	0.710	0.705	0.685
3	0.195	0.002	0.135	<0.005	<0.005
5	0.049	<0.005	0.074	<0.005	<0.005
10	0.012	<0.005	0.009	<0.005	<0.005
20	0.004	<0.005	0.002	<0.005	<0.005
30	0.001	<0.005	<0.005	<0.005	<0.005
60	<0.005	<0.005	<0.005	<0.005	<0.005

Note: LPUV = Low-pressure UV lamp; MPUV = Medium-pressure UV lamp; HP = Hydrogen peroxide.

The ozonated systems all performed similarly by removing TCE to sub-detection limit levels within 3 min of treatment. The two peroxone systems performed slightly better than the LPUV/ozone system by removing TCE to subdetection limit levels within 3 min of treatment, while the LPUV/ozone system actually had low amounts of TCE detected in 3 min (0.002 mg/l).

RDX

Table 4 presents the RDX removal data for the AOPs evaluated. From Table 4, the LPUV/ozone system was far superior to the other candidate AOPs tested in terms of complete RDX removal. However, in terms of meeting the target treatment goals, all of the UV irradiated systems met target treatment goals (0.002 mg/l) within 5 min of treatment. This is not surprising since RDX is very photoreactive, especially within the UV light bands. The MPUV and LPUV hydrogen peroxide systems performed very similarly to each in terms of RDX removal. Neither of these two systems completely removed RDX to subdetection limit levels (i.e., <0.0002 mg/l) until 60 min of treatment. As expected, the MPUV light source provided a slightly better rate of removal compared with the LPUV system due to its higher energy output within the region RDX absorbs UV and the better quantum yield afforded with hydrogen peroxide using the MPUV.

The 100-mg/l hydrogen peroxide-dosed peroxone system removed RDX to below target treatment goals within 60 min of treatment. Conversely, the 10-mg/l hydrogen peroxide-dosed system did not meet target treatment goals by the 60-min mark. The 10-mg/l hydrogen peroxide peroxone removed RDX to 0.0042 mg/l, which is twice that of the target goal of 0.002 mg/l selected for this study.

Table 4 RDX Removal from NOP Groundwater					
Test Time min	Contaminant Concentrations, mg/l				
	MPUV/ 100 HP	LPUV/ Ozone	LPUV/ 100 HP	Peroxone (10 HP)	Peroxone (100 HP)
0	0.0144	0.0128	0.0134	0.0128	0.0130
3	0.0021	0.0003	0.0036	0.0105	0.0083
5	0.0007	<0.0002	0.0032	0.0086	0.0080
10	0.0004	<0.0002	0.0021	0.0077	0.0064
20	0.0005	<0.0002	0.0009	0.0071	0.0040
30	0.0002	<0.0002	0.0020	0.0062	0.0034
60	<0.0002	<0.0002	<0.0002	0.0042	0.0019

Note: LPUV = Low-pressure UV lamp; MPUV = Medium-pressure UV lamp; HP = Hydrogen peroxide.

HMX

Table 5 presents the HMX data for the various AOPs evaluated. From this table, HMX was already present at levels over two orders of magnitude below the target treatment goal of 0.4 mg/l.

The LPUV/ozone and MPUV/hydrogen peroxide systems removed HMX to subdetection limit levels within 5 min of treatment. The LPUV/hydrogen peroxide system did not remove HMX to subdetection limit levels within 60 min of treatment evaluated during this study; however, it did remove HMX to the detection limit by 60 min. The difference in performance between the LPUV/ozone and LPUV/hydrogen peroxide systems is interesting; if photolysis was the primary removal mechanism for HMX, it is expected that they would perform similarly. However, since the maximum absorbance of HMX is approximately 232 nm,¹ which is within the high-absorbance band area for hydrogen peroxide, competition for UV photons within this area may have hindered either photolysis of hydrogen peroxide into hydroxyl radicals (if oxidation by radical species was the primary removal mechanism) or direct photolysis of the HMX (if photolysis was the primary removal mechanism). The vastly better performance of the LPUV/ozone system in terms of HMX cannot explain the poor performance of the LPUV/hydrogen peroxide system because the LPUV/ozone, due to the lack of photon competition (ozone absorbs at a much higher wavelength (254 nm) than HMX), could be removing HMX by either oxidation and/or photolysis.

¹ Personal Communication, 1995, Dr. Mohammad Qasim, U.S. Army Engineer Waterways Experiment Station, Vicksburg, MS.

**Table 5
HMX Removal from NOP Groundwater**

Test Time min	Contaminant Concentrations, mg/l				
	MPUV/ 100 HP	LPUV/ Ozone	LPUV/ 100 HP	Peroxone (10 HP)	Peroxone (100 HP)
0	0.0029	0.0028	0.0028	0.0026	0.0027
3	0.0004	<0.0002	0.0014	0.0027	0.0020
5	<0.0002	<0.0002	0.0010	0.0024	0.0020
10	<0.0002	<0.0002	0.0006	0.0020	0.0018
20	<0.0002	<0.0002	0.0004	0.0022	0.0022
30	<0.0002	<0.0002	0.0005	0.0020	0.0014
60	<0.0002	<0.0002	0.0002	0.0017	0.0015

Note: LPUV = Low-pressure UV lamp; MPUV = Medium-pressure UV lamp; HP = Hydrogen peroxide.

The peroxone systems both performed similarly by only removing approximately 50 percent of HMX within 60 min of treatment. This indicates that HMX is not very reactive with hydroxyl radicals (i.e., HMX is not very reactive with oxidizing agents). Photon competition between the HMX and hydrogen peroxide, thereby reducing the extent of photolysis achievable, was the likely reason for the performance of the LPUV/hydrogen peroxide system compared with the LPUV/ozone system.

TNT/TNB

TNT was almost never detected in the influents used during this study. When TNT was detected in the test influents, it was present at levels below 0.002 mg/l (the target treatment goal) and was removed by those AOPs within 3 min of treatment. TNB, a by-product of TNT oxidation/photolysis, was not detected in any of the test influents nor any of the samples collected during treatment of the Mead groundwater.

2-amino-4,6-dinitrotoluene (2A-DNT)

2A-DNT was detected in most of the test influents used during this study. The 2A-DNT removal data are listed in Table 6 for all of the AOPs evaluated. There was not a treatment goal established for 2A-DNT; however, these data are presented (along with the 4A-DNT data discussed in the next section) to further evaluate the performance of the various AOPs for removing nitro-based cyclic organics from the

Table 6 2A-DNT Removal from NOP Groundwater					
Test Time min	Contaminant Concentrations, mg/l				
	MPUV/ 100 HP	LPUV/ Ozone	LPUV/ 100 HP	Peroxone (10 HP)	Peroxone (100 HP)
0	0.0004	0.0002	0.0003	0.0005	0.0003
3	<0.0002	<0.0002	0.0002	0.0002	0.0002
5	<0.0002	<0.0002	<0.0002	<0.0002	0.0002
10	0.0002	<0.0002	<0.0002	0.0001	0.0002
20	<0.0002	<0.0002	0.0005	0.0001	<0.0002
30	0.0001	<0.0002	0.0001	<0.0002	<0.0002
60	0.0001	<0.0002	0.0002	<0.0002	<0.0002

Note: LPUV = Low-pressure UV lamp; MPUV = Medium-pressure UV lamp; HP = Hydrogen peroxide.

NOP groundwater. From Table 6, it appears that the ozonated systems provided much higher and complete 2A-DNT removal than did the hydrogen peroxide-based systems.

4-amino-2,6-dinitrotoluene (4A-DNT)

4A-DNT was detected in most of the test influents used during this study. Table 7 lists the results of the various AOP runs performed in terms of 4A-DNT removal. These data generally indicated somewhat mixed results due to the low levels of 4A-DNT present compared with the detection limits of the method used (0.0002 mg/l). Since the data exhibited such an extent of variation, firm conclusions cannot be made concerning the ability of the AOPs for removing 4A-DNT from the NOP groundwater.

Estimating of VOC volatilization from sparged reactors

Figure 4 presents the results of the PID analysis of the off-gases exiting the reactors. The potential for water vapor or ozone/hydrogen peroxide to register as an organic compound by the PID (via a hit on meter) was evaluated by sparging ozone into hydrogen peroxide-dosed DDI water. Since the PID did not register any hits, then any hits observed with the actual groundwater during zonation is believed to be actual organic contaminants.

The runs that used the NOP groundwater all had measurable amounts of VOCs exiting the reactors. The aerated experiments had detectable amounts of VOCs almost immediately with each experiment. The peroxone experiment began to have

Table 7 4A-DNT Removal from NOP Groundwater					
Test Time min	Contaminant Concentrations, mg/l				
	MPUV/ 100 HP	LPUV/ Ozone	LPUV/ 100 HP	Peroxone (10 HP)	Peroxone (100 HP)
0	0.0007	0.0009	0.0008	0.0004	0.0004
3	0.0001	0.0008	0.0005	0.0004	0.0003
5	0.0001	0.0012	0.0004	0.0002	0.0002
10	0.0001	0.0009	0.0002	0.0002	0.0003
20	<0.0002	0.0006	0.0003	0.0002	0.0010
30	0.0002	0.0008	0.0001	0.0002	0.0007
60	0.0003	0.0007	0.0003	0.0002	0.0004

Note: LPUV = Low-pressure UV lamp; MPUV = Medium-pressure UV lamp; HP = Hydrogen peroxide.

measurable amounts after 2 to 3 min of operation. Unfortunately, the PID does not have the capability to separate and identify individual organic species (i.e., no chromatographic separation such as a GC/MS). These data clearly indicate that VOCs are exiting the reactors; however, the type of VOCs exiting cannot be estimated. It is a good hypothesis that the aerated runs were likely volatilizing the VOCs that were present in the groundwater influent without any chemical transformation occurring. It is possible that the AOP runs were stripping volatile organic acids (carboxylics), a by-product of primary contaminant oxidation, from the reactor. Organic acids would still be registered as organic carbon by the PID. This theory of TCE being converted to organic acids that are in turn volatilized would account for the delay in the registration of VOCs in the AOP runs. The LPUV/ozone system clearly had the least amount of volatilization occurring, suggesting that this system was mineralizing a greater percentage of the VOCs present.

The highest VOC concentration in the off-gases exiting any of the PID experiments was 0.45 ppm. These experiments indicate that stripping may be a factor in terms of VOC removal. Unfortunately, exact quantification of the extent of stripping cannot be estimated using the PID. However, the possibility that the organics measured in the off-gases from the AOP systems were volatile organics is high based on the rapid depletion of the TCE within the first 3 min of treatment, yet the PID registered organic compounds (OC) in the off-gases well beyond this time increment. Comparing the results listed in Table 3 to the PID data illustrated in Figure 3 supports this theory. By 3 min, no detectable amount of TCE was present in the LPUV/ozone and peroxone systems, yet the PID data indicate detectable organics present in the off-gases well beyond 15 min.

MEAD ARMY AMMUNITION PLANT (MAAP) GROUNDWATER - OFFGASES

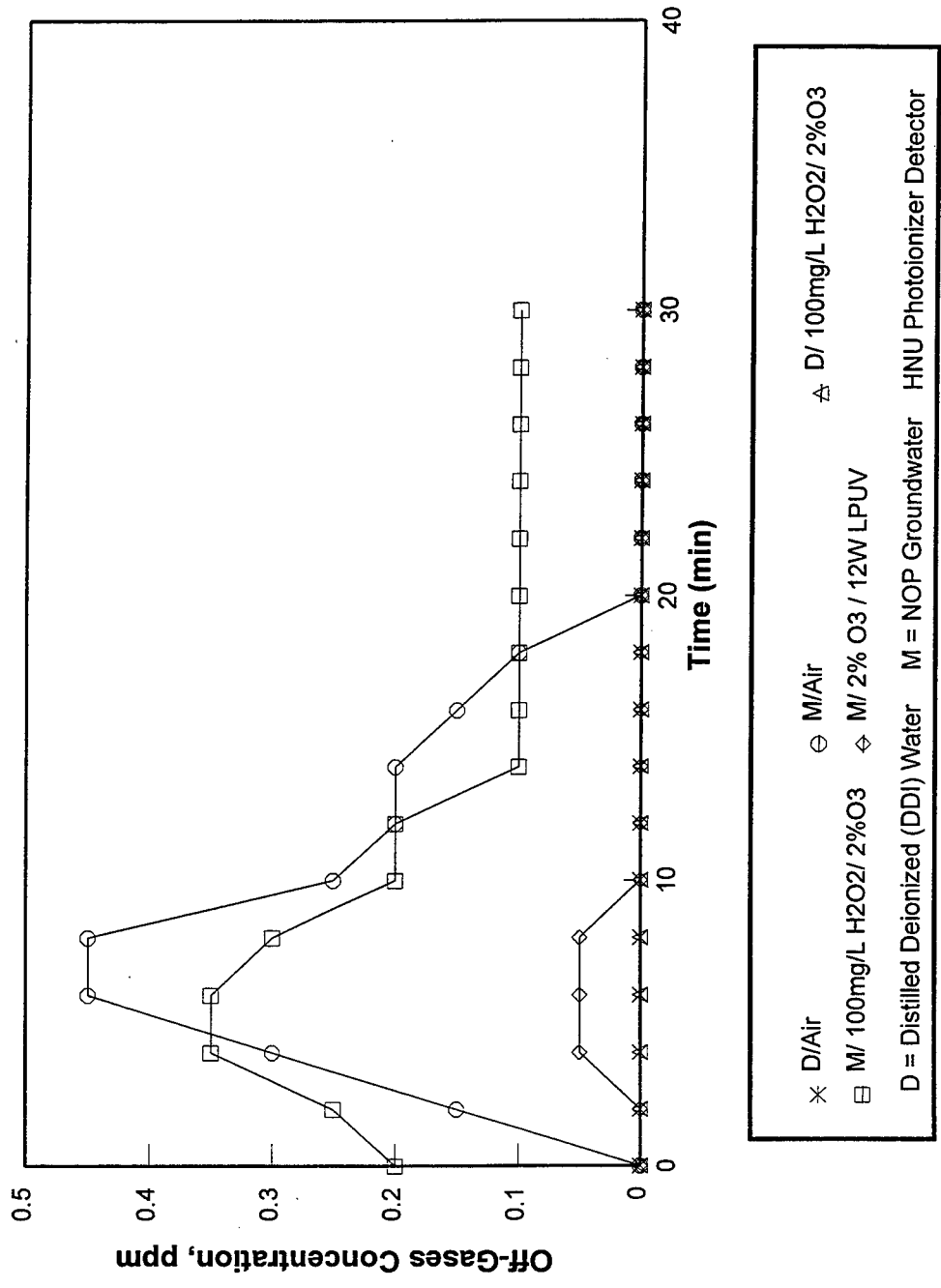

Figure 4. Evaluation of reactor off-gases using a PID

Summary

Table 8 lists the treatment times required by each candidate AOP to reach target treatment goals (see Table 1). Table 8 also lists the critical contaminants for each that are limiting the AOP from meeting the target goals for complete treatment and the respective minimum HRT required to remove the critical contaminant to target levels. It is not surprising that the UV-intensive systems were limited by TCE removal, which is not very photoreactive (Sunstrom et al. 1986). On the other hand, the peroxone systems were limited by RDX, which is very photoreactive (Zappi, Hong, and Cerar 1993).

Analyte	Time to Reach Target Treatment Goals, min				
	MPUV/HP	LPUV/OZ	LPUV/HP	PER/10HP	PER/100 HP
TCE	<20	<3	<20	<3	<3
RDX	<5	<3	<20	NR	<60
HMX	0	0	0	0	0
TNT	0	0	0	0	0
TNB	0	0	0	0	0
AOP Critical Contaminant:	TCE	TCE/RDX	TCE/RDX	RDX	RDX
Minimum HRT:	20 min	3 min	20 min	>60 min	60 min

Note: NR = Not reached within the 60 min of treatment evaluated.

The LPUV/ozone was obviously the best of all the AOPs evaluated. This AOP provided excellent conditions that yielded rapid degradation rates. Both RDX and TCE are listed as critical contaminants; however, their respective minimum HRTs are only 3 min. Both MPUV/hydrogen peroxide and LPUV/hydrogen peroxide had TCE as their critical contaminant. They both also required 20-min HRTs to remove TCE.

The peroxone systems had the longest minimum HRT of all the AOPs tested. RDX was the critical contaminant for both peroxone systems. The 10-mg/l hydrogen peroxide-dosed system did not remove RDX to target levels within the 60-min HRT used, while 60-min was the minimum HRT required for the 100-mg/l hydrogen peroxide-dosed peroxone system to meet the 0.002-mg/l RDX treatment goal.

Some of the TCE may have been volatilized in the ozone-sparged experiments. The volatilization experiments indicated a difference in the apparent amount of organic carbon exiting the system. The LPUV/ozone system clearly had the least

amount of contaminant volatilization. It is believed that the total amount of contaminant removal obtained via stripping is likely to be minimal.

4 Engineering Significance

The results of this study clearly indicate that all of the candidate AOPs except the 10-mg/l hydrogen peroxide-dosed peroxone system can be used for treatment of NOP-contaminated waters. This allows the design team to select an AOP strictly on an economic basis. The more traditional commercialized AOPs (MPUV/hydrogen peroxide and LPUV/ozone) offer well-designed, field-ready units that are skid mounted. These AOPs also have a large experience base that can be relied upon to give a high potential for operational success.

The LPUV/hydrogen peroxide and peroxone systems offer the design team options that potentially are much more cost effective than the more traditional AOPs. Unfortunately, neither system has a long history of application for remediation of contaminated groundwaters on an appreciable scale. Peroxone has been used for municipal water treatment on a multimillion gallon per day scale with a high degree of success.

As stated above, the results of this study clearly indicate that advanced oxidation offers an attractive option for treating the NOP groundwater. These processes result in the onsite destruction of the contaminants, plus they are flexible enough in terms of changing influent chemical matrices to be adjusted to maintain appropriate effluent qualities. The LPUV/ozone and MPUV/hydrogen peroxide systems are relatively well established with competent vendors available. However, peroxone and LPUV/hydrogen peroxide are not well developed. It is suggested that onsite pilot studies be performed to evaluate these systems using dynamic reactors. This information can further support the bench results and possibly lead into the use of one of these cost-effective AOPs at the NOP.

Suggested design considerations of an AOP treating the NOP-contaminated groundwater are that the system should be plug-flow to prevent the expensive loss of oxidizers over the weir of the system via the effluent. The hydrogen peroxide should be dosed on a continual basis, which makes the design of such systems more complex. In terms of peroxone design, this feature should be considered to maximize the reaction rate achievable by keeping the hydrogen peroxide/ozone ratio at an optimum (i.e., 0.2 to 1.0). The residence times should be designed around the contaminant that had the slowest degradation rate for each of the candidate AOPs under consideration (i.e., the critical contaminant). The critical contaminants varied with each AOP evaluated during this study.

Based on the positive results of previous and several ongoing studies at WES, a pilot-scale peroxone unit has been constructed and was recently tested at Rocky Mountain Arsenal (RMA), Colorado. The system was used to treat groundwater that was contaminated with low levels of diisopropylmethylphosphonate. Results are very encouraging further substantiating the findings of this study and others on-going by WES as to the potential for peroxone to treat contaminated groundwaters. Zappi et al. (1994) summarize the preliminary results of a pilot study completed at RMA during August 1994 (Appendix B) and illustrate the type of information that can be generated using a dynamic pilot system such as the Peroxone Oxidation Pilot System (POPS).

5 Conclusions

The primary conclusion of this study is that all of the AOPs except the 10-mg/ℓ hydrogen peroxide-dosed peroxone system appear capable of reaching the target treatment goals set for the NOP site. The LPUV/ozone system was the best performer in terms of rate and extent of contaminant removal. The 100-mg/ℓ hydrogen peroxide-dosed system appears to be the next best performer, followed closely the MPUV/hydrogen peroxide system. The LPUV/hydrogen peroxide system did meet target treatment goals at a much slower and, in some cases, less complete manner.

There appears to be significant optimization that can be done on both the peroxone and LPUV/hydrogen peroxide systems. This effort can be done using either bench- or pilot-scale equipment. Pilot-scale, dynamic systems would deliver better design-quality information on both processes.

References

- Aieta, E. M., Reagan, K. M., Lang, J. S., McReynolds, L., Kang, J. W., and Glaze, W. H. (1988). "Advanced oxidation processes for treating groundwater contaminated with TCE and PCE: Pilot-scale evaluations," *Journal American Water Works Association* 80, 5.
- American Water Works Association and Compagnie Generale des Faux. (1991). *Ozone in water treatment*. Lewis Publishers, Inc., Chelsea, MI.
- Barich, J. T., and Zeff, J. D. (1989). "A review of ultrox ultraviolet oxidation technology as applied to industrial groundwater, wastewater, and superfund sites." *Proceedings from 1989 Superfund Conference*. HMCRI.
- Burrows, W. (1983). "Tertiary treatment of effluent from Holston AAP Industrial Liquid Waste Treatment Facility. III. Ultraviolet radiation and ozone studies: TNT, RDX, HMX, TAX, and SEX," Technical Report 8306, U.S. Army Armament Research and Development Center, Dover, NJ.
- DeBerry, D., Viehbeck A., and Meldrum D. (1984). "Basic mechanisms of explosive compounds in wastewater," U.S. Army Toxic and Hazardous Materials Agency, Aberdeen Proving Ground, Report No. DRXTH-TE-CR-84279.
- Fochtman, E., and Huff, J. E. (1975). "Ozone-ultraviolet light treatment of TNT wastewaters," International Ozone Institute 2nd Symposium on Ozone Technology, Montreal, May 11-14.
- Froelich, E. M. (1992). "Advanced chemical oxidation of contaminated water using the Perox-Pure™ oxidation system." *Chemical oxidation: Technologies for the nineties*. Eckenfelder, Bowers, and Roth, ed., Technomic Publishers, Lancaster, PA.
- Glaze, W. H., and Kang, J. W. (1988). "Advanced oxidation processes for treating groundwater contaminated with TCE and PCE: Laboratory studies," *Journal American Water Works Association* 80, 5.

- Hager, D. G., Lovern, C. G., and Giggy, C. L. (1987). "Chemical oxidation destruction of organic contaminants in groundwater," 1987 Superfund Conference, HMCRI 4, 32.
- Hong A., Zappi, M., and Kuo, C. (1994). "A laboratory study on the treatment of explosive contaminated groundwater by advanced oxidation processes," Presented in the '94 ASCE National Conference, July 11-13, 1994, Boulder, CO.
- Hong, A. Zappi, M., Kuo, C., and Hill, D. (1996). "Modeling the kinetics of illuminated and dark advanced oxidation processes," *Journal Of Environmental Engineering* 122, 58-62.
- James Montgomery Engineers, Inc. (1985). *Water treatment principals and design*. John Wiley and Sons, Inc., New York.
- Jody, B. J., Klein, M. J., and Judeikis, H. (1989). "Catalytic O₃/UV treatment of wastewater containing mixtures of organic and inorganic pollutants." *Proceedings of the 9th World Ozone Congress*. New York.
- Langlais, B., Reckhow, D. A., and Brink, D. R. (1991). *Ozone in water treatment*. Lewis Publishers, Chelsea, MI.
- Layne, W., Nicholson, R., Wahl, R., O'Brien, P., Jackson, B., and LaChowski, J. (1982). "Ultraviolet-ozone treatment of pink wastewater: A pilot scale study," U.S. Army Armament Research and Development Command, Dover, NJ, ARLCD-CR-82023.
- Mayer, G. J., Bellamy, W. D., Ziemba, N., and Otis, L. A. (1990). "Conceptual cost evaluation of volatile organic compound treatment by advanced oxidation," Second Forum on Innovative Hazardous Waste Treatment Technologies: Domestic and International, May 15-17, 1990, Philadelphia, PA.
- Metcalf and Eddy, Inc. (1991). *Wastewater engineering: Treatment, disposal, and reuse*. McGraw-Hill Publishing, Inc., New York.
- Metropolitan Water District of Southern California. (1991). *Pilot-scale evaluation of ozone and peroxone*. American Water Works Association, Denver, CO.
- Peyton, G. R., Michelle, A. S., and Peyton, B. M. (1987). *Photolytic ozonation for protection and rehabilitation of ground-water resources; A mechanistic study*. Report Number 206, University of Illinois, Water Resource Center, Urbana, IL.
- Sundstrom, D. W., Klei, H. E., Nalette, T. A., Reidy, D. J., and Weir, B. A. (1986). "Destruction of halogenated aliphatics by ultraviolet catalyzed chemical oxidation with hydrogen peroxide," *Hazardous Waste and Hazardous Materials* 3, 1.

- Sundstrom, D. W., Weir, B. A., and Klei, H. E. (1989). "Destruction of aromatic pollutants by UV light catalyzed oxidation with hydrogen peroxide," *Environmental Progress* 8, 1.
- Zappi, M. E., Fleming, E. C., and Cullinane, M. J. (1992). "Treatment of contaminated groundwater using chemical oxidation." *Proceedings of the Hydraulic Engineering Sessions*. Water Forum '92, American Society of Civil Engineers, Baltimore, MD.
- Zappi, M. E., Fleming, E. C., Thompson, D. W., and Francingues, N. R. (1990). "Treatability study of four contaminated waters at Rocky Mountain Arsenal, Commerce City, Colorado, using chemical oxidation with ultraviolet radiation catalyzation." *Proceedings of 14th Annual Army Environmental Research and Development Symposium*. U.S. Army Toxic and Hazardous Materials Agency, Williamsburg, VA.
- Zappi, M., Hong, A., and Cerar, R. (1993). "Treatment of groundwater contaminated with high levels of explosives using traditional and non-traditional advanced oxidation processes," 1993 HMCRI Superfund Conference, Washington, DC.
- Zappi, M., Swindle, R., Harvey, S., Morgan, R., Strang, D., and Smith, J. (1994). "Pilot scale evaluation of peroxone for treatment of contaminated groundwater," 1994 HMCRI Superfund Conference, Washington, DC, November 1994.

Appendix A

Raw Analytical Data

**Table A1
Temperature and pH Values for Advanced Oxidation Processes
Experiments in Mead Army Ammunition Plant (MAAP)
Groundwater**

Label	Time, min	pH	Temp, °C
Low-Pressure Mercury Lamp			
12-W/2% Ozone¹			
MAAP1-0	0	6.91	22.4
MAAP1-3	3	7.46	20.7
MAAP1-5	5	7.62	20.7
MAAP1-10	10	7.86	21.0
MAAP1-20	20	8.03	21.0
MAAP1-30	30	8.12	20.9
MAAP1-60	60	8.03	20.4
MAAP6-0	0	6.91	23.6
MAAP6-3	3	7.82	23.7
MAAP6-5	5	8.02	23.7
MAAP6-10	10	8.23	23.7
MAAP6-20	20	8.30	23.7
MAAP6-30	30	8.31	23.7
MAAP6-60	60	8.02	23.9
12-W/2% Ozone²			
MAAP11-0	0	6.78	24.1
MAAP11-3	3	7.63	24.1
MAAP11-5	5	7.62	24.1
MAAP11-1	10	8.05	24.2
MAAP11-2	20	8.25	24.4
MAAP11-3	30	8.35	24.6
MAAP11-6	60	8.37	24.9
MAAP16-0	0	7.16	24.7
MAAP16-3	3	7.67	25.9
MAAP16-5	5	7.74	25.8
MAAP16-1	10	8.24	25.8
MAAP16-2	20	7.58	25.7
MAAP16-3	30	8.21	25.7
MAAP16-6	60	8.23	24.7
<i>(Sheet 1 of 5)</i>			
¹ 40-ml VOC samples. ² 1-l Explosives samples.			

Table A1 (Continued)			
Label	Time, min	pH	Temp, °C
Low-Pressure Mercury Lamp (Continued)			
12-W/100-mg/l Hydrogen Peroxide¹			
MAAP3-0	0	6.95	21.3
MAAP3-3	3	6.92	21.4
MAAP3-5	5	6.93	21.5
MAAP3-10	10	6.89	21.5
MAAP3-20	20	6.85	21.5
MAAP3-30	30	6.87	21.5
MAAP3-60	60	6.95	21.5
MAAP9-0	0	6.86	23.7
MAAP9-3	3	6.81	23.9
MAAP9-5	5	6.91	24.0
MAAP9-10	10	6.78	24.0
MAAP9-20	20	6.75	24.1
MAAP9-30	30	6.76	24.1
MAAP9-60	60	6.97	24.0
12-W/100-mg/l Hydrogen Peroxide²			
MAAP13-0	0	6.93	24.9
MAAP13-3	3	6.76	24.7
MAAP13-5	5	6.92	23.5
MAAP13-1	10	7.09	23.6
MAAP13-2	20	7.13	23.7
MAAP13-3	30	7.09	24.1
MAAP13-6	60	7.06	24.5
MAAP19-0	0	6.97	25.1
MAAP19-3	3	6.81	23.9
MAAP19-5	5	6.91	24.0
MAAP19-1	10	6.78	24.0
MAAP19-2	20	6.75	24.1
MAAP19-3	30	6.76	24.1
MAAP19-6	60	6.97	24.0
Medium-Pressure Mercury Lamp			
200-W/100-mg/l Hydrogen Peroxide¹			
MAAP5-0	0	6.92	22.7
MAAP5-3	3	6.63	23.0
MAAP5-5	5	6.57	23.0
MAAP5-10	10	6.55	22.7
<i>(Sheet 2 of 5)</i>			

Table A1 (Continued)			
Label	Time, min	pH	Temp, °C
Medium-Pressure Mercury Lamp (Continued)			
200-W/100-mg/l Hydrogen Peroxide ¹ (Continued)			
MAAP5-20	20	6.63	22.8
MAAP5-30	30	6.64	22.7
MAAP5-60	60	6.77	22.7
MAAP10-0	0	6.96	25.1
MAAP10-3	3	6.94	25.2
MAAP10-5	5	7.12	25.3
MAAP10-1	10	6.78	25.4
MAAP10-2	20	6.79	25.4
MAAP10-3	30	6.79	25.4
MAAP10-6	60	6.89	25.5
200-W/100-mg/l Hydrogen Peroxide ²			
MAAP15-0	0	7.08	25
MAAP15-3	3	7.16	25.1
MAAP15-5	5	7.14	25.1
MAAP15-1	10	7.18	25.2
MAAP15-2	20	7.14	24.7
MAAP15-3	30	7.28	25.2
MAAP15-6	60	7.32	25.4
MAAP20-0	0	6.96	25.1
MAAP20-3	3	6.94	25.2
MAAP20-5	5	7.12	25.3
MAAP20-1	10	6.78	25.4
MAAP20-2	20	6.79	25.4
MAAP20-3	30	6.79	25.4
MAAP20-6	60	6.89	25.5
100-mg/l Hydrogen Peroxide/2% Ozone ¹			
MAAP2-0	0	6.94	20.7
MAAP2-3	3	7.71	20.7
MAAP2-5	5	7.90	20.7
MAAP2-10	10	8.07	20.7
MAAP2-20	20	8.17	21.0
MAAP2-30	30	8.18	20.7
MAAP2-60	60	7.98	21.0
MAAP7-0	0	6.97	23.7
MAAP7-3	3	7.71	24.0
(Sheet 3 of 5)			

Table A1 (Continued)			
Label	Time, min	pH	Temp, °C
Medium-Pressure Mercury Lamp (Continued)			
100-mg/l Hydrogen Peroxide/2% Ozone¹ (Continued)			
MAAP7-5	5	7.92	23.9
MAAP7-10	10	8.18	24.0
MAAP7-20	20	8.09	24.0
MAAP7-30	30	8.21	24.0
MAAP7-60	60	7.87	23.9
100-mg/l Hydrogen Peroxide/2% Ozone²			
MAAP12-0	0	6.93	25.5
MAAP12-3	3	7.66	25.5
MAAP12-5	5	7.90	25.4
MAAP12-1	10	8.20	25.4
MAAP12-2	20	8.16	25.4
MAAP12-3	30	8.09	25.5
MAAP12-6	60	7.98	25.8
MAAP17-0	0	7.19	25.2
MAAP17-3	3	7.68	25.7
MAAP17-5	5	7.69	25.7
MAAP17-1	10	7.81	25.7
MAAP17-2	20	8.19	25.7
MAAP17-3	30	8.09	25.7
MAAP17-6	60	7.94	25.7
Peroxone			
10-mg/l Hydrogen Peroxide/2% Ozone¹			
MAAP4-0	0	6.65	20.4
MAAP4-3	3	7.46	20.4
MAAP4-5	5	7.84	20.4
MAAP4-10	10	8.06	20.4
MAAP4-20	20	8.13	20.4
MAAP4-30	30	7.99	20.4
MAAP4-60	60	7.92	20.5
MAAP8-0	0	6.72	24.7
MAAP8-3	3	7.67	24.7
MAAP8-5	5	7.91	24.8
MAAP8-10	10	8.03	24.7
MAAP8-20	20	8.21	24.7
MAAP8-30	30	8.26	24.8
MAAP8-60	60	8.22	24.9

(Sheet 4 of 5)

Table A1 (Concluded)

Label	Time, min	pH	Temp, °C
Peroxone (Continued)			
10-mg/l Hydrogen Peroxide/2% Ozone ²			
MAAP14-0	0	6.96	23.5
MAAP14-3	3	7.43	23.6
MAAP14-5	5	7.57	23.3
MAAP14-1	10	7.51	23.2
MAAP14-2	20	7.68	23.5
MAAP14-3	30	7.66	20.4
MAAP14-6	60	7.58	20.5
MAAP18-0	0	6.91	25.1
MAAP18-3	3	7.67	24.7
MAAP18-5	5	7.91	24.8
MAAP18-1	10	8.03	24.7
MAAP18-2	20	8.21	24.7
MAAP18-3	30	8.26	24.8
MAAP18-6	60	8.22	24.9

(Sheet 5 of 5)

Table A2

Trichloroethylene, mg/l. MPUV and LPUV Oxidation Runs									
Run No.	MAAP1	MAAP6	Average	MAAP3	MAAP9	Average	MAAP5	MAAP10	Average
UV Source	12 W	12 W	12 W	12 W	12 W	12 W	200 W	200 W	200 W
H ₂ O ₂ dose, mg/l	--	--	--	100	100	100	100	100	100
O ₃ feed, %	2	2	2	--	--	--	--	--	--
Test time, min									
0	0.66	0.72	0.69	0.73	0.69	0.71	0.68	0.71	0.695
3	<0.0050	0.0021 J	0.0023	0.15	0.12	0.135	0.20	0.19	0.195
5	<0.0050	<0.0050	<0.005	0.11	0.038	0.074	0.053	0.045	0.049
10	<0.0050	<0.0050	<0.005	0.014	0.0039 J	0.00895	0.022	0.0021 J	0.01205
20	<0.0050	<0.0050	<0.005	0.0020 J	<0.0050	0.00225	0.0065	0.00081 J	0.003655
30	<0.0050	<0.0050	<0.005	<0.0050	<0.0050	<0.0050	0.0022	0.00058 J	0.00139
60	<0.0050	<0.0050	<0.005	<0.0050	<0.0050	<0.0050	<0.0050	<0.0050	<0.005
% Removal			99.64			99.65			99.64

Trichloroethylene, mg/l. Peroxone Oxidation Runs									
Run No.	MAAP2	MAAP7	Average	MAAP4	MAAP8	Average	MAAP5	MAAP10	Average
H ₂ O ₂ dose, mg/l	100	100	100	10	10	10			
O ₃ feed, %	2	2	2	2	2	2			
Test time, min									
0	0.67	0.70	0.685	0.71	0.70	0.705			
3	0.0018 J	0.0035 J	0.00265	<0.0050	<0.0050	<0.0050			
5	<0.0050	<0.0050	<0.005	<0.0050	<0.0050	<0.0050			
10	<0.0050	<0.0050	<0.005	<0.0050	<0.0050	<0.0050			
20	<0.0050	<0.0050	<0.005	<0.0050	<0.0050	<0.0050			
30	<0.0050	<0.0050	<0.005	<0.0050	<0.0050	<0.0050			
60	<0.025	<0.0050	<0.005	<0.0050	<0.025	<0.0050			
% Removal			99.64			99.65			

Table A3

Methylene Chloride, mg/l, MPUV and LPUV Oxidation Runs

Run No.	MAAP1	MAAP6	Average	MAAP3	MAAP9	Average	MAAP5	MAAP10	Average
UV Source	12 W	12 W	12 W	12 W	12 W	12 W	200 W	200 W	200 W
H ₂ O ₂ dose, mg/l	--	--	--	100	100	100	100	100	100
O ₃ feed, %	2	2	2	--	--	--	--	--	--
Test time, min									
0	0.0016 J	<0.025	0.00705	<0.025	<0.025	<0.025	<0.025	<0.025	<0.025
3	<0.0050	<0.0050	<0.0050	<0.0050	<0.0050	<0.0050	<0.0050	<0.0050	<0.0050
5	<0.0050	<0.0050	<0.0050	<0.0050	<0.0050	<0.0050	<0.0050	<0.0050	<0.0050
10	<0.0050	<0.0050	<0.0050	<0.0050	<0.0050	<0.0050	<0.0050	<0.0050	<0.0050
20	<0.0050	<0.0050	<0.0050	<0.0050	<0.0050	<0.0050	<0.0050	<0.0050	<0.0050
30	<0.0050	<0.0050	<0.0050	<0.0050	<0.0050	<0.0050	<0.0050	<0.0050	<0.0050
60	<0.0050	<0.0050	<0.0050	<0.0050	<0.0050	<0.0050	<0.0050	<0.0050	<0.0050
% Removal			29.08			--			--

Methylene Chloride, mg/l, Peroxone Oxidation Runs

Run No.	MAAP2	MAAP7	Average	MAAP4	MAAP8	Average
H ₂ O ₂ dose, mg/l	100	100	100	10	10	10
O ₃ feed, %	2	2	2	2	2	2
Test time, min						
0	0.00069 J	<0.025	0.00660	<0.025	<0.025	<0.025
3	<0.0050	<0.0050	<0.0050	<0.0050	<0.0050	<0.0050
5	<0.0050	<0.0050	<0.0050	<0.0050	<0.0050	<0.0050
10	<0.0050	<0.0050	<0.0050	<0.0050	<0.0050	<0.0050
20	<0.0050	<0.0050	<0.0050	<0.0050	<0.0050	<0.0050
30	<0.0050	<0.0050	<0.0050	<0.0050	<0.0050	<0.0050
60	<0.0050	<0.0050	<0.0050	<0.0050	<0.025	<0.0050
% Removal			--			--

Table A4

Acetone (mg/L), MPUV and LPUV Oxidation Runs									
Run No.	MAAP1	MAAP6	Average	MAAP3	MAAP9	Average	MAAP5	MAAP10	Average
UV Source	12 W	12 W	12 W	12 W	12 W	12 W	200 W	200 W	200 W
H ₂ O ₂ dose, mg/l	--	--	--	100	100	100	100	100	100
O ₃ feed, %	2	2	2	--	--	--	--	--	--
Test time, min									
0	<0.13	<0.13	<0.13	<0.13	0.032 J	0.0485	0.026 J	<0.13	0.0455
3	0.016 BJ	0.0036 J	0.0098	<0.025	0.0033 J	0.0079	<0.025	<0.025	<0.025
5	0.016 BJ	<0.025	0.01425	<0.025	0.0044 J	0.00845	<0.025	<0.025	<0.025
10	<0.0050	<0.025	<0.005	0.0055 J	0.0014 J	0.00345	<0.025	0.0026 J	0.00755
20	<0.0050	0.0042 J	0.00335	0.0078 J	0.0034 J	0.0056	<0.025	0.025	0.01875
30	0.012 BJ	0.0074 J	0.0097	0.011 J	0.0075 J	0.00925	<0.025	0.0034 J	0.00795
60	<0.025	0.011 J	0.01175	0.010 J	0.0086 J	0.0093	<0.025	0.0039 J	0.0082
% Removal			20.48			80.82			81.98

Acetone, mg/l, Peroxone Oxidation Runs									
Run No.	MAAP2	MAAP7	Average	MAAP4	MAAP8	Average			
H ₂ O ₂ dose, mg/l	100	100	100	10	10	10			
O ₃ feed, %	2	2	2	2	2	2			
Test time, min									
0	<0.13	<0.13	<0.13	<0.13	<0.13	<0.13			
3	<0.025	<0.025	<0.025	0.0034 J	<0.025	0.00795			
5	<0.025	<0.025	<0.025	<0.025	0.0029 J	0.0077			
10	<0.025	<0.025	<0.025	0.010 J	0.020 J	0.015			
20	0.017 J	0.0061 J	0.01155	<0.025	<0.025	<0.025			
30	0.013 J	0.020 J	0.0165	<0.025	<0.025	<0.025			
60	0.013 J	0.028	0.0205	0.026	0.031 JE	0.0285			
% Removal			17.12			14.04			

Table A5

2-Butanone, mg/l, MPUV and LPUV Oxidation Runs										
Run No.	MAAP1	MAAP6	Average	MAAP3	MAAP9	Average	MAAP5	MAAP10	Average	
UV Source	12 W	12 W	12 W	12 W	12 W	12 W	200 W	200 W	12 W	200 W
H ₂ O ₂ dose, mg/l	--	--	--	100	100	100	100	100	100	100
O ₃ feed, %	2	2	2	--	--	--	--	--	--	--
Test time, min										
0	<0.13	<0.13	<0.13	<0.13	<0.13	<0.13	<0.13	<0.13	<0.13	<0.13
3	<0.025	<0.025	<0.025	<0.025	<0.025	<0.025	<0.025	<0.025	<0.025	<0.025
5	<0.025	<0.025	<0.025	<0.025	<0.025	<0.025	<0.025	<0.025	<0.025	<0.025
10	<0.025	<0.025	<0.025	<0.025	<0.025	<0.025	<0.025	<0.025	<0.025	<0.025
20	0.0026 J	<0.025	0.00755	<0.025	<0.025	<0.025	<0.025	<0.025	<0.025	<0.025
30	<0.025	<0.025	<0.025	<0.025	<0.025	<0.025	<0.025	<0.025	<0.025	<0.025
60	<0.025	<0.025	<0.025	<0.025	<0.025	<0.025	<0.025	<0.025	<0.025	<0.025
% Removal			--						--	--

2-Butanone, mg/l, Peroxone Oxidation Runs										
Run No.	MAAP2	MAAP7	Average	MAAP4	MAAP8	Average				
H ₂ O ₂ dose, mg/l	100	100	100	10	10	10				
O ₃ feed, %	2	2	2	2	2	2				
Test time, min										
0	<0.13	<0.13	<0.13	<0.13	<0.13	<0.13				
3	<0.025	<0.025	<0.025	<0.025	<0.025	<0.025				
5	<0.025	<0.025	<0.025	<0.025	<0.025	<0.025				
10	<0.025	<0.025	<0.025	<0.025	<0.025	<0.025				
20	<0.025	<0.025	<0.025	0.0028 J	<0.025	0.00765				
30	<0.025	<0.025	<0.025	<0.025	<0.025	<0.025				
60	<0.025	<0.025	<0.025	<0.025	<0.13	<0.025				
% Removal			--			--				

Table A6

RDx, mg/l. MPUV and LPUV Oxidation Runs									
Run No.	MAAP11	MAAP16	Average	MAAP13	MAAP19	Average	MAAP15	MAAP20	Average
UV Source	12 W	12 W	12 W	12 W	12 W	12 W	200 W	200 W	200 W
H ₂ O ₂ dose, mg/l	--	--	--	100	100	100	100	100	100
O ₃ feed, %	2	2	2	--	--	--	--	--	--
Test time, min									
0	0.01310	0.01240	0.01275	0.01290	0.01380	0.01335	0.01370	0.0150	0.01435
3	0.00046	<0.00020	0.00028	0.00175	0.00543	0.00359	0.00225	0.00190	0.002075
5	<0.00020	<0.00020	<0.00020	0.00154	0.00478	0.00316	0.00050	0.00092	0.00071
10	<0.00020	<0.00020	<0.00020	0.00029	0.00398	0.002135	0.00044	0.00027	0.000355
20	<0.00020	<0.00020	<0.00020	<0.00020	0.00335	0.000938	0.00028	0.00072	0.00050
30	<0.00020	<0.00020	<0.00020	0.00026	0.00308	0.00167	0.00021	<0.00020	0.000155
60	<0.00020	<0.00020	<0.00020	<0.00020	<0.00020	<0.00020	<0.00020	<0.00020	<0.00020
% Removal			99.22			99.25			99.30

RDx, mg/l. Peroxone Oxidation Runs									
Run No.	MAAP12	MAAP17	Average	MAAP14	MAAP18	Average	MAAP15	MAAP20	Average
H ₂ O ₂ dose, mg/l	100	100	100	10	10	10			
O ₃ feed, %	2	2	2	2	2	2			
Test time, min									
0	0.01310	0.01290	0.01300	0.01310	0.01250	0.01280			
3	0.01030	0.00632	0.00831	0.01220	0.00879	0.010495			
5	0.00817	0.00783	0.00800	0.00942	0.00782	0.00862			
10	0.00537	0.00735	0.00636	0.00747	0.00796	0.007715			
20	0.00237	0.00564	0.004005	0.0081	0.00616	0.00713			
30	0.00165	0.00522	0.003435	0.00718	0.00529	0.006235			
60	0.00100	0.00281	0.001905	0.00472	0.00365	0.004185			
% Removal			85.35			67.30			

Table A7

HMX, mg/l. MPUV and LPUV Oxidation Runs										
Run No.	MAAP11	MAAP16	Average	MAAP13	MAAP19	Average	MAAP15	MAAP20	Average	
UV Source	12 W	12 W	12 W	12 W	12 W	12 W	200 W	200 W	200 W	200 W
H ₂ O ₂ dose, mg/l	--	--	--	100	100	100	100	100	100	100
O ₃ feed, %	2	2	2	--	--	--	--	--	--	--
Test time, min										
0	0.00302	0.00276	0.00289	0.00260	0.00293	0.002765	0.00276	0.00311	0.002935	
3	<0.00020	<0.00020	<0.00020	0.00121	0.00139	0.00130	0.00068	<0.00020	0.00039	
5	<0.00020	<0.00020	<0.00020	0.00081	0.00111	0.00096	<0.00020	<0.00020	<0.00020	
10	<0.00020	<0.00020	<0.00020	<0.00020	0.00106	0.00058	<0.00020	<0.00020	<0.00020	
20	<0.00020	<0.00020	<0.00020	<0.00020	0.00073	0.000415	<0.00020	<0.00020	<0.00020	
30	<0.00020	<0.00020	<0.00020	<0.00020	0.00083	0.000465	<0.00020	<0.00020	<0.00020	
60	<0.00020	<0.00020	<0.00020	0.00026	<0.00020	0.00018	<0.00020	<0.00020	<0.00020	
% Removal			96.54			93.49				96.59

HMX, mg/l. Peroxone Oxidation Runs										
Run No.	MAAP12	MAAP17	Average	MAAP14	MAAP18	Average				
H ₂ O ₂ dose, mg/l	100	100	100	10	10	10				
O ₃ feed, %	2	2	2	2	2	2				
Test time, min										
0	0.00266	0.00277	0.00271	0.00261	0.00250	0.002555				
3	0.00234	0.00165	0.00200	0.00342	0.00203	0.002725				
5	0.00198	0.00191	0.00195	0.00274	0.00195	0.002345				
10	0.00147	0.00207	0.00177	0.00183	0.00212	0.001975				
20	0.00085	0.00352	0.00219	0.00239	0.00192	0.002155				
30	0.00070	0.00213	0.00142	0.00205	0.00188	0.001965				
60	0.00127	0.00169	0.00148	0.00192	0.00144	0.001680				
% Removal			45.49			34.25				

Table A8

2,4,6-Trinitrotoluene, mg/l, MPUV and LPUV Oxidation Runs									
Run No.	MAAP11	MAAP16	Average	MAAP13	MAAP19	Average	MAAP15	MAAP20	Average
UV Source	12 W	12 W	12 W	12 W	12 W	12 W	200 W	200 W	200 W
H ₂ O ₂ dose, mg/l	--	--	--	100	100	100	100	100	100
O ₃ feed, %	2	2	2	--	--	--	--	--	--
Test time, min									
0	0.00018 J	<0.00020	0.00014	<0.00020	<0.00020	<0.00020	<0.00020	<0.00020	<0.00020
3	<0.00020	<0.00020	<0.00020	<0.00020	<0.00020	<0.00020	<0.00020	<0.00020	<0.00020
5	<0.00020	<0.00020	<0.00020	<0.00020	<0.00020	<0.00020	<0.00020	<0.00020	<0.00020
10	<0.00020	<0.00020	<0.00020	<0.00020	<0.00020	<0.00020	<0.00020	<0.00020	<0.00020
20	<0.00020	<0.00020	<0.00020	<0.00020	<0.00020	<0.00020	<0.00020	<0.00020	<0.00020
30	<0.00020	<0.00020	<0.00020	<0.00020	<0.00020	<0.00020	<0.00020	<0.00020	<0.00020
60	<0.00020	<0.00020	<0.00020	<0.00020	<0.00020	<0.00020	<0.00020	<0.00020	<0.00020
% Removal			28.57			--			--

2,4,6-Trinitrotoluene, mg/l, Peroxone Oxidation Runs									
Run No.	MAAP12	MAAP17	Average	MAAP14	MAAP18	Average	MAAP15	MAAP20	Average
H ₂ O ₂ dose, mg/l	100	100	100	10	10	10	200 W	200 W	200 W
O ₃ feed, %	2	2	2	2	2	2	100	100	100
Test time, min									
0	<0.00020	0.00016 J	0.00013	0.00016 J	<0.00020	0.00013			
3	<0.00020	<0.00020	<0.00020	<0.00020	<0.00020	<0.00020			
5	<0.00020	<0.00020	<0.00020	<0.00020	<0.00020	<0.00020			
10	<0.00020	<0.00020	<0.00020	<0.00020	<0.00020	<0.00020			
20	<0.00020	<0.00020	<0.00020	<0.00020	<0.00020	<0.00020			
30	<0.00020	<0.00020	<0.00020	<0.00020	<0.00020	<0.00020			
60	<0.00020	<0.00020	<0.00020	<0.00020	<0.00020	<0.00020			
% Removal			23.08			23.08			

Table A9

1,3,5-Trinitrobenzene, mg/l. MPUV and LPUV Oxidation Runs									
Run No.	MAAP11	MAAP16	Average	MAAP13	MAAP19	Average	MAAP15	MAAP20	Average
UV Source	12 W	12 W	12 W	12 W	12 W	12 W	200 W	200 W	200 W
H ₂ O ₂ dose, mg/l	--	--	--	100	100	100	100	100	100
O ₃ feed, %	2	2	2	--	--	--	--	--	--
Test time, min									
0	<0.00020	<0.00020	<0.00020	<0.00020	<0.00020	<0.00020	<0.00020	<0.00020	<0.00020
3	<0.00020	<0.00020	<0.00020	<0.00020	<0.00020	<0.00020	<0.00020	<0.00020	<0.00020
5	<0.00020	<0.00020	<0.00020	<0.00020	<0.00020	<0.00020	<0.00020	<0.00020	<0.00020
10	<0.00020	<0.00020	<0.00020	<0.00020	<0.00020	<0.00020	<0.00020	<0.00020	<0.00020
20	<0.00020	<0.00020	<0.00020	<0.00020	<0.00020	<0.00020	<0.00020	<0.00020	<0.00020
30	<0.00020	<0.00020	<0.00020	<0.00020	<0.00020	<0.00020	<0.00020	<0.00020	<0.00020
60	<0.00020	<0.00020	<0.00020	<0.00020	<0.00020	<0.00020	<0.00020	<0.00020	<0.00020
% Removal			--			--			--

1,3,5-Trinitrobenzene, mg/l. Peroxone Oxidation Runs									
Run No.	MAAP12	MAAP17	Average	MAAP14	MAAP18	Average	MAAP15	MAAP20	Average
H ₂ O ₂ dose, mg/l	100	100	100	10	10	10	200 W	200 W	200 W
O ₃ feed, %	2	2	2	2	2	2	100	100	100
Test time, min							--	--	--
0	<0.00020	<0.00020	<0.00020	<0.00020	<0.00020	<0.00020	<0.00020	<0.00020	<0.00020
3	<0.00020	<0.00020	<0.00020	<0.00020	<0.00020	<0.00020	<0.00020	<0.00020	<0.00020
5	<0.00020	<0.00020	<0.00020	<0.00020	<0.00020	<0.00020	<0.00020	<0.00020	<0.00020
10	<0.00020	<0.00020	<0.00020	<0.00020	<0.00020	<0.00020	<0.00020	<0.00020	<0.00020
20	<0.00020	<0.00020	<0.00020	<0.00020	<0.00020	<0.00020	<0.00020	<0.00020	<0.00020
30	<0.00020	<0.00020	<0.00020	<0.00020	<0.00020	<0.00020	<0.00020	<0.00020	<0.00020
60	<0.00020	<0.00020	<0.00020	<0.00020	<0.00020	<0.00020	<0.00020	<0.00020	<0.00020
% Removal			--			--			--

Table A10

2-Amino-4,6-Dinitrotoluene, mg/l. MPUV and LPUV Oxidation Runs

Run No.	MAAP11	MAAP16	Average	MAAP13	MAAP19	Average	MAAP15	MAAP20	Average
UV Source	12 W	12 W	12 W	12 W	12 W	12 W	200 W	200 W	200 W
H ₂ O ₂ dose, mg/l	--	--	--	100	100	100	100	100	100
O ₃ feed, %	2	2	2	--	--	--	--	--	--
Test time, min									
0	0.00023	<0.00020	0.000165	0.00052	<0.00020	0.00031	0.00075	<0.00020	0.000425
3	<0.00020	<0.00020	<0.00020	0.00016 J	<0.00020	0.00013	<0.00020	<0.00020	<0.00020
5	<0.00020	<0.00020	<0.00020	<0.00020	<0.00020	<0.00020	<0.00020	<0.00020	<0.00020
10	<0.00020	<0.00020	<0.00020	<0.00020	<0.00020	<0.00020	0.00014 J	<0.00020	0.00017
20	<0.00020	<0.00020	<0.00020	0.00053	<0.00020	0.000315	<0.00020	<0.00020	<0.00020
30	<0.00020	<0.00020	<0.00020	0.00014 J	<0.00020	0.00012	0.00011 J	<0.00020	0.000105
60	<0.00020	<0.00020	<0.00020	0.00015 J	<0.00020	0.000125	0.00012 J	<0.00020	0.00011
% Removal			39.39			56.68			74.12

2-Amino-4,6-Dinitrotoluene, mg/l. Peroxone Oxidation Runs

Run No.	MAAP12	MAAP17	Average	MAAP14	MAAP18	Average
H ₂ O ₂ dose, mg/l	100	100	100	10	10	10
O ₃ feed, %	2	2	2	2	2	2
Test time, min						
0	0.00058	<0.00020	0.00034	0.00079	<0.00020	0.000445
3	0.00036	<0.00020	0.00023	0.00023	<0.00020	0.000165
5	0.00032	<0.00020	0.00021	<0.00020	<0.00020	<0.00020
10	0.00030	<0.00020	0.00020	0.00015 J	<0.00020	0.000125
20	<0.00020	<0.00020	<0.00020	0.00011 J	<0.00020	0.000105
30	<0.00020	<0.00020	<0.00020	<0.00020	<0.00020	<0.00020
60	<0.00020	<0.00020	<0.00020	<0.00020	<0.00020	<0.00020
% Removal			70.59			77.53

Table A11

4-Amino-2,6-Dinitrotoluene, mg/l. MPUV and LPUV Oxidation Runs									
Run No.	MAAP11	MAAP16	Average	MAAP13	MAAP19	Average	MAAP15	MAAP20	Average
UV Source	12 W	12 W	12 W	12 W	12 W	12 W	200 W	200 W	200 W
H ₂ O ₂ dose, mg/l	--	--	--	100	100	100	100	100	100
O ₃ feed, %	2	2	2	--	--	--	--	--	--
Test time, min									
0	0.00075	0.00113	0.00094	0.00074	0.00078	0.00076	0.00075	0.00071	0.00073
3	0.00081	0.0008	0.000805	0.00069	0.00022	0.000455	0.00012 J	<0.00020	0.00011
5	0.00172	0.00068	0.0012	0.00049	0.00024	0.000365	0.00014 J	<0.00020	0.00012
10	0.00164	<0.00020	0.00087	0.00036	<0.00020	0.00023	0.00018 J	<0.00020	0.00014
20	0.00113	<0.00020	0.000615	0.00057	<0.00020	0.000335	<0.00020	<0.00020	<0.0002
30	0.00151	<0.00020	0.000805	0.00016 J	<0.00020	0.00013	0.00036	<0.00020	0.00023
60	0.00132	<0.00020	0.00071	0.00039	<0.00020	0.000245	0.00043	<0.00020	0.000265
% Removal			24.47			67.76			63.70

4-Amino-2,6-Dinitrotoluene, mg/l. Peroxone Oxidation Runs									
Run No.	MAAP12	MAAP17	Average	MAAP14	MAAP18	Average			
H ₂ O ₂ dose, mg/l	100	100	100	10	10	10			
O ₃ feed, %	2	2	2	2	2	2			
Test time, min									
0	0.00073	<0.00020	0.000415	0.00074	<0.00020	0.00042			
3	0.00046	<0.00020	0.00028	0.00062	<0.00020	0.00036			
5	0.00037	<0.00020	0.000235	0.00031	<0.00020	0.000205			
10	0.00057	<0.00020	0.000335	0.00021	<0.00020	0.000155			
20	0.00184	<0.00020	0.00097	0.00032	<0.00020	0.00021			
30	0.00127	<0.00020	0.000685	0.00022	<0.00020	0.00016			
60	0.00078	<0.00020	0.00044	0.00029	<0.00020	0.000195			
% Removal			-6.02			53.57			

Appendix B

Peroxone Pilot Study Paper

Presented by the author at the 1994 Superfund Conference
at Washington DC, November 1994

PILOT SCALE EVALUATION OF PEROXONE FOR TREATMENT OF CONTAMINATED GROUNDWATER

Mark Zappi

Randy Swindle

Steve Harvey

Robert Morgan

Environmental Laboratory

USAE Waterways Experiment Station

Vicksburg, Mississippi

David Strang

James Smith

Office of Program Manager

Rocky Mountain Arsenal

Commerce City, Colorado

Abstract

Advance oxidation processes are treatment processes that rely on the hydroxyl radical to destroy contaminants in polluted waters. Peroxone is an advanced oxidation process that utilizes the reaction of ozone and hydrogen peroxide to produce hydroxyl radicals without the requirement of ultraviolet light. The U.S. Army Engineer Waterways Experiment Station evaluated the use of peroxone at Rocky Mountain Arsenal (RMA) for treatment of groundwater contaminated with diisopropylmethylphosphonate (DIMP) and low levels of pesticides. This evaluation was performed at RMA using a pilot-scale treatment system. Results indicate that DIMP was easily oxidized to below detection limit levels. Optimization of the process indicated that a 250-mg/l hydrogen peroxide dose in

four columns plumbed in series were all sparged with 2.2-percent ozonated air at a rate of 2.5 scfm.

Introduction

Rocky Mountain Arsenal (RMA) is an installation of the U.S. Army occupying more than 17,000 acres in Adams County, Commerce City, CO. RMA was established in 1942 and has been the site of chemical incendiary munitions manufacturing and chemical munitions demilitarization. Following World War II, Congress approved the leasing of some portions of RMA to private industry. Agricultural pesticides and herbicides were manufactured onsite from 1947 to 1982. Past military and industrial activities at RMA have resulted in the contamination of the alluvial aquifer with various organic compounds such as diisopropylmethylphosphonate (DIMP), pesticides, and volatile organic compounds.

In support of the Office of The Program Manager Rocky Mountain Arsenal (PMRMA), the U.S. Army Engineer Waterways Experiment Station (WES) evaluated peroxone for treatment of contaminated groundwaters using a pilot-scale peroxone oxidation system. These activities focused on evaluating the feasibility of using peroxone as either a pretreatment technology for the removal of organic contaminants from the influents to existing RMA systems that do not adsorb well onto activated carbon, such as DIMP (thus reducing the activated carbon usage as a cost-saving measure), or for direct remediation of the contaminated groundwater. This paper summarizes some of the results generated by this study that was recently performed at RMA by WES during August 1994.

The Peroxone Process

Chemical oxidation processes that result in the generation of the hydroxyl radical (OH[•]) have been referred to as advanced oxidation processes (AOPs) by the American Water Works Association (Langlais, Reckhow, and Brink 1991). Commercial application of AOPs for contaminated groundwater treatment in the United States has traditionally involved ultraviolet (UV) irradiation of hydrogen peroxide, ozone, or a combination of both. In UV light-based AOPs, irradiation of chemical oxidizers with UV light produces hydroxyl radicals. The hydroxyl radical is a much more powerful oxidizer than either hydrogen peroxide or ozone (Sundstrom et al. 1986).

Peroxone is an AOP that utilizes the combination of hydrogen peroxide and ozone to form the hydroxyl radical without the requirement of UV light. The results reported by Glaze and Kang (1988) indicated that peroxone could effectively degrade chlorinated solvents from the groundwater. Since peroxone does not require the addition of high concentrations of chemical oxidizers and UV light, it is estimated that reductions in treatment costs as high as an order of magnitude over more traditional AOPs may be realized.

Langlais, Reckhow, and Brink (1991) present the following mechanism for the formation of the hydroxyl radical during peroxone treatment:

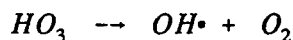
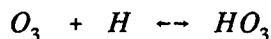
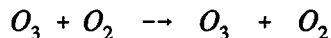
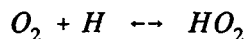
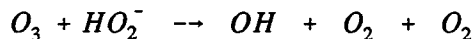
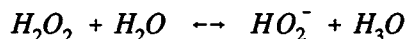

Discussions with French researchers indicate that some water utilities in France are currently using peroxone to treat millions of gallons per day of pesticide-contaminated groundwater.¹ The French researchers claim that treatment costs are on the order of \$0.05 per 1,000 gal treated. Glaze and Kang (1988) performed laboratory-scale studies on the ability of peroxone to remove TCE and tetrachloroethylene (PCE) from a contaminated groundwater. The results proved positive enough to warrant subsequent pilot-scale evaluations (Aieta et al. 1988). Both the bench and pilot studies concluded that the reaction rate of TCE and PCE was increased by factors of 1.8 to 2.8 and 2.0 to 6.5, respectively, as opposed to those achieved by ozonation alone. Apparently, TCE was reactive toward ozone alone as well as the hydroxyl radicals formed; PCE was only reactive toward the radical species. Both studies indicated that a hydrogen peroxide-to-ozone ratio between 0.25 and 0.5 was optimal for removing TCE and PCE from the groundwater studied. The Metropolitan Water District of Southern California (1991) evaluated peroxone using pilot-scale systems for treatment of 2-methylisobornel (MIB) and trans-1,10-dimethyl-trans-9-decanol (geosmin). The District concluded that optimum hydrogen peroxide-to-ozone ratios for removal of MIB and geosmin was 0.1 to 0.2. They further conclude that peroxone was better for removal of MIB and geosmin than ozone alone due to increased hydroxyl radical production.

Researchers at WES have recently developed a numerical model for estimating the steady-state hydroxyl radical concentrations in peroxone systems (under publication). The hydroxyl radical production and destruction mechanisms as described by the WES model are presented in the equation below,

$$[OH^\bullet] = \frac{(2k_6 [O_3] [H_2O_2] K_{H2O2} [H^+])}{(k_4 [O_3]) + (k_5 [H_2O_2]) + (k_X [X]) + (k_s [S])}$$

¹ Personal Communication, 1992, with Dr. Marcel Dore, University of Poitiers, France.

where

X = Target contaminant

S = Radical scavengers

K and k = Rate constants

The above model indicates that there are numerous chemical reactions that may occur that can remove hydroxyl radical species from a reactor fluid. Only those reactions that either result in production of the radical (shown in the numerator of the equation) and/or the destruction of the contaminant are considered beneficial (the X term in the denominator). The other reactions have an adverse impact on reaction kinetics due to the scavenging of radicals that would have been available for contaminant destructive reactions.

Based on radical production/reaction chemistry, WES has identified three predominant scavenging reactions that will most likely govern reactions within traditional AOP reactor systems when treating contaminated groundwaters. These are reactions with bicarbonate/carbonate ions, reduced cations (i.e., iron), and excessive amounts of primary oxidizers (i.e., ozone and hydrogen peroxide). Of particular interest to this study is that too much ozone or hydrogen peroxide may be added to an AOP system. Usually obtaining excessive amounts of ozone is difficult because ozonation is mass transfer limited (gas to water transfer). However, introduction of hydrogen peroxide (a liquid) is much easier and is likely a potential scavenging source in AOPs. There is an optimum dose for each oxidizer and an optimum stoichiometric mass-to-mass ratios for those AOPs utilizing both oxidizers, such as peroxone. Some of the data presented in this report serve as excellent examples of these interactions.

Study Background and Objectives

In 1993, WES evaluated the potential for three AOPs for removal of DIMP from RMA groundwaters. AOPs evaluated include UV/hydrogen peroxide, UV/ozone, and peroxone. These efforts were accomplished using 1- ℓ bench reactors. The results from this effort indicate that any time UV light was added to the hydrogen peroxide system or ozone, extremely rapid degradation rates were observed. Although the peroxone system did not have as rapid degradation as the UV-based processes, appreciable degradation of DIMP was observed. The peroxone bench study indicated that hydraulic residence times (HRTs) in excess of 30 min will be required to remove DIMP to below detection limit levels (BDLLs). The parent oxidizers used in the bench study, ozone and hydrogen peroxide, were found not to be reactive toward DIMP. This indicates that the primary removal mechanism for DIMP was the hydroxyl radical and/or photolysis.

The results of the bench studies for DIMP removal were considered promising. The UV-based systems had more rapid DIMP degradation rates than the peroxone

systems. Unfortunately, UV-based systems are more expensive than peroxone systems and are sensitive to influent UV transmissivity. UV-based systems are also susceptible to fouling of the quartz tubes that house the UV lamps. Peroxone oxidation is estimated to cost as low as an order of magnitude lower than traditional UV-based AOPs and are not susceptible to problems associated with iron fouling or poor influent UV transmissivity. Therefore, further evaluation of peroxone oxidation for DIMP removal to BDLLs was initiated using a WES-developed and constructed pilot-scale system with the objective of evaluating the two application scenarios discussed above.

Equipment Description

The peroxone oxidation pilot system (POPS) used in this study was designed and constructed by WES. The system had the capability of evaluating influent flow rates ranging from 0.5 to 15 gal per minute (gpm). For this study, a constant flow rate of 0.9 gpm was used. The system was plumbed in a countercurrent flow mode with the hydrogen peroxide-dosed influent flowing downward and the ozonated gas flowing upward through the columns. Hydrogen peroxide doses were mixed with the influent using an in-line vortex mixer.

The POPS unit used a 3-lb-per-day Orec ozone generator capable of producing a continuous stream of air containing up to 2.5-percent ozone (wt/wt). Ozonated air was introduced into four 6-in. ID by 14-ft-high, all-glass columns via ceramic spargers located on the column bottoms. A central data logging system control unit comprised of a Gateway 486, 200 Mbyte, 50 MHz computer was used for on-screen operations analysis of process operations that were used for system operation and real-time data logging. Hydrogen peroxide was introduced into the influent stream using a metering pump to precisely dose the peroxone system with hydrogen peroxide of varying strengths (depending on the target dosage). Two IN-USA ozone monitors were used with the system for gas phase analysis. One unit was used to monitor ozone generator output in percent ozone (wt/wt). The other unit had multipoint capability for analyzing air phase ozone concentrations at various sampling points including column headspace, preozone and postozone destruct unit, and ambient air. An IN-USA in-line ozone monitor with multipoint capability will be used for analyzing residual ozone levels in the effluents exiting any of the four columns. Ozone exiting the columns that was not transferred into the column influents was passed through an ozone destruct system to prevent release of ozone into the ambient air. DIMP is not volatile, so there were no concerns about DIMP loss via volatilization during ozonation.

Approach

RMA groundwater was used as the influent for this study. This influent contains DIMP at approximate levels that approach 100 ppb. The POPS unit was operated at a constant ozone feed of 2.2 percent ozone at a flow rate of 2.5 scfm with varying hydrogen peroxide doses into the influent added prior to entry into the first column.

Influent was added to the system at a constant flow rate of 0.9 gpm, which represented an approximate system HRT of 90 min (23 min per column). Analytical samples for DIMP analysis using gas chromatography were collected periodically after each POPS column in precleaned all-glass, 1-ℓ sample bottles. DIMP analyses were performed by the RMA Analytical Laboratory. Ozone and hydrogen peroxide concentrations exiting the columns were also recorded.

Results

A DIMP concentration of BDLLs ($<1.78 \mu\text{g}/\ell$) was selected as a target treatment goal for comparison of process formulation performance. Tables B1-B3 summarize the results of the POPS runs for hydrogen peroxide doses of 100, 250, and 500 mg/ℓ , respectively. These data indicate that the 250- mg/ℓ dose (Table B2) had slightly more rapid removal kinetics than the 100- mg/ℓ dose (Table B1). The addition of 500 mg/ℓ (Table B3) had a slight inhibitory effect on DIMP removal. The mechanism of rate inhibition is believed to be the reaction of hydroxyl radicals with the excessively high amounts of hydrogen peroxide present in the reactors (Table B3). The WES steady-state hydroxyl radical model for peroxone presented earlier illustrates how excessive amounts of either oxidizer may hinder contaminant degradation rate. In fact, the rationale for the 100- mg/ℓ hydrogen peroxide dose to perform slightly worse than the 250- mg/ℓ dose was attributed to excessive amounts of ozone present in the column, which reacted with some of the hydroxyl radicals produced because of the limited amounts of hydrogen peroxide present in the columns. This effect is also illustrated in the steady-state hydroxyl radical model for peroxone systems.

Sample Location ¹	Cumulative HRT, min	Water (H_2O_2) mg/ℓ	Water (O_3), mg/ℓ	Water (DIMP) $\mu\text{g}/\ell$
Influent	0	100	0	70
Column 1	23	80	0.6	14
Column 2	46	30	BDL	BDL
Column 3	69	1	0.3	BDL
Column 4	93	0.2	BDL	BDL

Note: BDL = Below detection limit (0.1 mg/ℓ for oxidizers and 1.78 $\mu\text{g}/\ell$ for DIMP).
¹ Column data based on samples collected directly after exiting the column.

Table B2 250-mg/ℓ Hydrogen Peroxide-Dosed POPS Run				
Sample Location¹	Cumulative HRT, min	Water (H₂O₂) mg/ℓ	Water (O₃), mg/ℓ	Water (DIMP) µg/ℓ
Influent	0	250	0	65
Column 1	23	200	1.7	10
Column 2	46	125	1.2	BDL
Column 3	69	50	0.4	BDL
Column 4	93	0.2	BDL	BDL

Note: BDL = Below detection limit (0.1 mg/ℓ for oxidizers and 1.78 µg/ℓ for DIMP).
¹ Column data based on samples collected directly after exiting the column.

Table B3 500-mg/ℓ Hydrogen Peroxide-Dosed POPS Run				
Sample Location¹	Cumulative HRT, min	Water (H₂O₂) mg/ℓ	Water (O₃), mg/ℓ	Water (DIMP) µg/ℓ
Influent	0	500	0	60
Column 1	23	500	2.0	14
Column 2	46	350	1.9	3.7
Column 3	69	275	2.0	BDL
Column 4	93	200	1.6	BDL

Note: BDL = Below detection limit (0.1 mg/ℓ for oxidizers and 1.78 µg/ℓ for DIMP).
¹ Column data based on samples collected directly after exiting the column.

In summary, all three hydrogen peroxide doses were capable of meeting the target treatment goal of BDLLs. The 100- and 250-mg/ℓ doses reached target levels within an HRT range of greater than 23 min, but less than 46 min. This HRT supports the results of the WES bench study, which predicted that an HRT of at least 30 min would be required to meet the BDLL target. The 500-mg/ℓ dose appeared to hinder DIMP oxidation reactions due to the excessive amounts of hydrogen peroxide present. This hindering effect is explained by the numerical model for steady-state hydroxyl radical concentrations in peroxone systems.

Further Efforts

The results of this study were considered very encouraging. Further analysis of the applicability of the peroxone process at RMA is ongoing. The 250-mg/ℓ hydrogen peroxide dose appeared to be the optimum process formulation for the conditions evaluated to date. However, WES has generated additional data using

varying ozone doses and flow rate. The steady-state (OH[·]) model predicts that reduced ozone and hydrogen peroxide doses may provide similar treatment efficiencies at significantly reduced treatment costs due to decreased oxidizer demands. These data are currently being evaluated and will be published when available.

Acknowledgments

The authors would like to thank the DoD's Strategic Environmental Research and Development Program and PMRMA for partnering the funding used for the performance of this study. The authors would also like to thank Messrs. Fred Ragan, David Gent, and Sidney Ragsdale, WES, and Messrs. Elisa Jones, Tom James, and Bob Stalworth, PMRMA, for their assistance. Permission to publish this information was granted by the Chief of Engineers.

References

- Aieta, E. M., Reagan, K. M., Lang, J. S., McReynolds, L., Kang, J. W., and Glaze, W. H. (1988). "Advanced oxidation processes for treating groundwater contaminated with TCE and PCE: Pilot-scale evaluations," *Journal American Water Works Association* 80, 5.
- Glaze, W. H., and Kang, J. W. (1988). "Advanced oxidation processes for treating groundwater contaminated with TCE and PCE: Laboratory studies," *Journal American Water Works Association* 80, 5.
- Langlais, B., Reckhow, D. A., and Brink, D. R. (1991). *Ozone in water treatment*. Lewis Publishers, Chelsea, MI.
- Metropolitan Water District of Southern California. (1991). *Pilot-scale evaluation of ozone and peroxone*. American Water Works Association, Denver, CO.
- Sundstrom, D. W., Klei, H. E., Nalette, T. A., Reidy, D. J., and Weir, B. A. (1986). "Destruction of halogenated aliphatics by ultraviolet catalyzed chemical oxidation with hydrogen peroxide," *Hazardous Waste and Hazardous Materials* 3, 1.

REPORT DOCUMENTATION PAGE

Form Approved
OMB No. 0704-0188

Public reporting burden for this collection of information is estimated to average 1 hour per response, including the time for reviewing instructions, searching existing data sources, gathering and maintaining the data needed, and completing and reviewing the collection of information. Send comments regarding this burden estimate or any other aspect of this collection of information, including suggestions for reducing this burden, to Washington Headquarters Services, Directorate for Information Operations and Reports, 1215 Jefferson Davis Highway, Suite 1204, Arlington, VA 22202-4302, and to the Office of Management and Budget, Paperwork Reduction Project (0704-0188), Washington, DC 20503.

1. AGENCY USE ONLY (Leave blank)		2. REPORT DATE June 1997	3. REPORT TYPE AND DATES COVERED Final report	
4. TITLE AND SUBTITLE Laboratory Assessment of Advanced Oxidation Processes for Treatment of Explosives and Chlorinated Solvents in Groundwater from the Former Nebraska Ordnance Plant			5. FUNDING NUMBERS	
6. AUTHOR(S) Elizabeth C. Fleming, Mark E. Zappi, Evelyn Toro, Rafael Hernandez, Karen Myers, Prasad Kodukula, Rosemary Gilbertson				
7. PERFORMING ORGANIZATION NAME(S) AND ADDRESS(ES) U.S. Army Engineer Waterways Experiment Station, 3909 Halls Ferry Road, Vicksburg, MS 39180-6199; Woodward-Clyde Consultants, Inc., 10975 El Monte, Suite 100, Overland Park, KS 66211; U.S. Army Engineer District, Kansas City, 700 Federal Building, Kansas City, MO 64106-2896			8. PERFORMING ORGANIZATION REPORT NUMBER Technical Report SERDP-97-3	
9. SPONSORING/MONITORING AGENCY NAME(S) AND ADDRESS(ES) U.S. Army Corps of Engineers, Washington, DC 20314-1000; U.S. Army Engineer District, Kansas City, 700 Federal Building, Kansas City, MO 64106-2896			10. SPONSORING/MONITORING AGENCY REPORT NUMBER	
11. SUPPLEMENTARY NOTES Available from National Technical Information Service, 5285 Port Royal Road, Springfield, VA 22161.				
12a. DISTRIBUTION/AVAILABILITY STATEMENT Approved for public release; distribution is unlimited.			12b. DISTRIBUTION CODE	
13. ABSTRACT (Maximum 200 words) Chemical oxidation processes that result in the generation of the hydroxyl radical (OH•) have been referred to as advanced oxidation processes (AOPs) by the American Water Works Association. The U.S. Army Engineer Waterways Experiment Station under the direction of the U.S. Army Engineer District, Kansas City, and in conjunction with Woodward-Clyde Consultants, Overland Park, KS, evaluated the comparative performance of four AOPs for removing trichloroethylene, RDX, HMX, trinitrotoluene, and 1,3,5-trinitrobenzene from a representative sample of groundwater from the Nebraska Ordnance Plant using bench-scale reactors. During 1990, this site was placed on the National Priorities List. Candidate AOPs that were evaluated were irradiation of hydrogen peroxide with ultraviolet (UV) light emitted from low-pressure mercury vapor UV lamps (LPUV-HP), irradiation with UV light emitted from a low-pressure mercury vapor UV lamp with ozone sparging (LPUV-OZ), irradiation of hydrogen peroxide with UV light emitted from a medium-pressure mercury vapor UV lamp (MPUV-HP), and peroxone (ozone sparging with hydrogen peroxide dosing). The groundwater influent sample used in this study was a three-way composite (equal parts) of groundwater collected from three site observation wells (Wells MW-11A, MW-40B, and MW-47B). The experiments were performed using a 1-l borosilicate reactor configured to sparge ozone into the test solution. This reactor has an inner immersion well that houses (Continued)				
14. SUBJECT TERMS Advanced oxidation process Explosives Hydrogen peroxide Mead			15. NUMBER OF PAGES 66	
			16. PRICE CODE	
17. SECURITY CLASSIFICATION OF REPORT UNCLASSIFIED	18. SECURITY CLASSIFICATION OF THIS PAGE UNCLASSIFIED	19. SECURITY CLASSIFICATION OF ABSTRACT	20. LIMITATION OF ABSTRACT	

13. (Concluded).

the UV lamps. A 200-W MPUV lamp and a 12-W LPUV lamp were used as light sources. Hydrogen peroxide was added according to the specific run conditions. Ozone was added semicontinuously via constant sparging of ozonated air (2-percent ozone). The fate of oxidants and contaminants was monitored by taking samples from the reactor at preset times during each experimental run. The volatile organic compound (VOC) analyses were run on a Hewlett-Packard gas chromatography/mass spectrometry system with a purge and trap system manufactured by O. I. Analytical using U.S. Environmental Protection Agency (USEPA) Method No. 8240. Explosives analyses were performed using USEPA Method 8330 using a Waters brand high performance liquid chromatography system operated with solid-phase preconcentration procedures. An HNU brand photoionizer detector was used to analyze the off-gases exiting various AOP systems to quantify the amount of VOCs stripped from the reactor during ozonation.

Process effectiveness was evaluated based on the ability of the AOP to meet the preset target treatment goals. For the specific operating conditions evaluated in this study, the LPUV/ozone system was the best performer in terms of rate and extent of contaminant removal. The MPUV/hydrogen peroxide (100 mg/l) was the next best performer, followed by the 100-mg/l hydrogen peroxide-dosed peroxone system. The LPUV system did meet target treatment goals at a much slower and, in some cases, less complete manner.