

4809 1



Windrow Composting Demonstration for Explosives- Contaminated Soils at the Umatilla Depot Activity Hermiston, Oregon

19950214 057

Report No. CETHA-TS-CR-93043
Contract No. DACA31-91-D-0079
Task Order No. 01

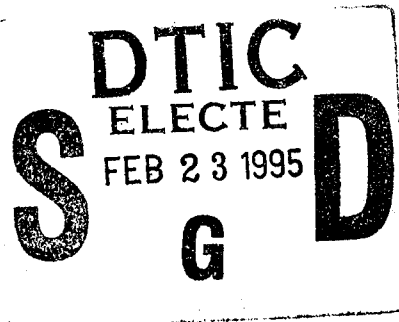

August 1993

DISTRIBUTION STATEMENT A
Approved for public release;
Distribution Unlimited

DTIC QUALITY INSPECTED 4

Prepared for:
U.S. Army Environmental Center (USAEC)
CET-HA-TD-5
Aberdeen Proving Ground, MD 21010-5401

Prepared by:
Roy F. Weston, Inc.
1 Weston Way
West Chester, Pennsylvania 19380-1499



C1086a

The reviews, opinions, and/or findings contained in this report should not be construed as an official Department of the Army position, policy, or decision, unless so designated by other documentation.

The use of trade names in this report does not constitute an official endorsement or approval of the use of such commercial products. This report may not be cited for purposes of advertisement.

REPORT DOCUMENTATION PAGE

Form Approved
OMB No. 0704-0188

1a. REPORT SECURITY CLASSIFICATION Unclassified		1b. RESTRICTIVE MARKINGS	
2a. SECURITY CLASSIFICATION AUTHORITY		3. DISTRIBUTION / AVAILABILITY OF REPORT Unlimited	
2b. DECLASSIFICATION / DOWNGRADING SCHEDULE			
4. PERFORMING ORGANIZATION REPORT NUMBER(S)		5. MONITORING ORGANIZATION REPORT NUMBER(S) CET-HA-TS-CR-93043	
6a. NAME OF PERFORMING ORGANIZATION Roy F. Weston, Inc.	6b. OFFICE SYMBOL (if applicable)	7a. NAME OF MONITORING ORGANIZATION U.S. Army Environmental Center (USAEC)	
6c. ADDRESS (City, State, and ZIP Code) 1 Weston Way West Chester, PA 19380		7b. ADDRESS (City, State, and ZIP Code) CET-HA-TD-5 Aberdeen Proving Ground, MD 21010-5401	
8a. NAME OF FUNDING / SPONSORING ORGANIZATION U.S. Army Environmental Center	8b. OFFICE SYMBOL (if applicable)	9. PROCUREMENT INSTRUMENT IDENTIFICATION NUMBER DACA31-91-D-0079	
8c. ADDRESS (City, State, and ZIP Code) CET-HA-TD-5 Aberdeen Proving Ground, MD 21010-5401		10. SOURCE OF FUNDING NUMBERS	
		PROGRAM ELEMENT NO.	PROJECT NO.
		TASK NO.	WORK UNIT ACCESSION NO. T01
11. TITLE (Include Security Classification) Windrow Composting Demonstration for Explosives-Contaminated Soils at Umatilla Depot Activity Hermiston, Oregon			
12. PERSONAL AUTHOR(S) Hammell, Lowe, Marks, Myers			
13a. TYPE OF REPORT Final	13b. TIME COVERED FROM 10/91 TO 5/93	14. DATE OF REPORT (Year, Month, Day) 1993, August	15. PAGE COUNT 300
16. SUPPLEMENTARY NOTATION			
17. COSATI CODES			18. SUBJECT TERMS (Continue on reverse if necessary and identify by block number) Composting; explosives; soil; windrow; DNT; TNT; RDX; HMX
FIELD	GROUP	SUB-GROUP	
19. ABSTRACT (Continue on reverse if necessary and identify by block number) The U.S. Army Environmental Center (USAEC) [formerly the U.S. Army Toxic and Hazardous Materials Agency (USATHAMA)] conducted windrow and seeding composting field studies at the Umatilla Depot Activity (UMDA) in Hermiston, Oregon. These tests supplemented previous aerated static pile (ASP) and mechanically agitated in-vessel (MAIV) studies with the goal of identifying a composting technique that can provide an acceptable and cost effective alternative to incineration for the treatment of explosives-contaminated soils. In the past, incineration has been the standard solution implemented for the treatment of explosives-contaminated soils; however, composting shows promise as a cost-effective and environmentally acceptable alternative. The seeding study investigated the usefulness of recycling a portion of active compost from ASP tests into the initial mixture of subsequent ASP tests. It was theorized that over time, an acclimated culture of organisms adapted for the biological degradation of explosives would be developed and that their continued incorporation into successive mixtures could result in a decrease in the retention time necessary to reach explosives reduction goals. While this principal of seeding and recycle is well-founded in waste treatment practice, clear benefits were not observed under the conditions tested in this study. The windrow study investigated the feasibility of employing a windrow composting approach for the remediation of explosives-contaminated soils and sediments. Both conventional unaerated windrows and mechanically aerated windrow tests were conducted. Preliminary testing was conducted using uncontaminated soils to establish operating parameters			
20. DISTRIBUTION / AVAILABILITY OF ABSTRACT <input checked="" type="checkbox"/> UNCLASSIFIED/UNLIMITED <input type="checkbox"/> SAME AS RPT. <input type="checkbox"/> DTIC USERS		21. ABSTRACT SECURITY CLASSIFICATION Unclassified	
22a. NAME OF RESPONSIBLE INDIVIDUAL Capt. Kevin Keehan and Mr. Wayne Sisk		22b. TELEPHONE (Include Area Code) 410-671-2054	22c. OFFICE SYMBOL ENAEC-TS-D

19. Testing was then conducted using contaminated soils to establish explosives removal performance. Analyses of compost samples taken at regular intervals throughout the study indicated rapid removal of the explosives compounds. By day 40 of the study, the percent reductions in the concentrations of TNT, RDX, and HMX in the aerated windrow were 99.8%, 99.2%, and 76.7%, respectively. Similarly, for the unaerated windrows, the reductions were 99.7%, 99.8%, and 96.8%, respectively. In addition, preliminary results have indicated significant reductions in leachability and toxicity for both windrows. These results indicate that windrow composting may be more effective than the previously tested ASP and MAIV systems. Furthermore, it was observed that the conventional unaerated windrow operation provided better reduction in explosives concentrations than the mechanically aerated system. Based on these results, it was concluded that windrow composting can effectively be used to remediate soils contaminated with TNT, RDX, and HMX.



**WINDROW COMPOSTING DEMONSTRATION FOR
EXPLOSIVES-CONTAMINATED SOILS
AT UMATILLA DEPOT ACTIVITY
HERMISTON, OREGON**

Prepared for

U.S. Army Environmental Center (USAEC)
Aberdeen Proving Ground, MD 21010-5401

Report No. CETHA-TS-CR-93043
Contract No. DACA31-91-D-0079
Task Order No. 01

August 1993

Prepared by

Roy F. Weston, Inc.
1 Weston Way
West Chester, PA 19380-1499

Accession For	
NTIS CRA&I	<input checked="" type="checkbox"/>
DTIC TAB	<input type="checkbox"/>
Unannounced	<input type="checkbox"/>
Justification	
By	
Distribution /	
Availability Codes	
Dist	Avail and/or Special
A-1	

TABLE OF CONTENTS

<u>Section</u>	<u>Title</u>	<u>Page</u>
ES	EXECUTIVE SUMMARY	E-1
1	BACKGROUND INFORMATION	1-1
	1.1 Nature of the Problem	1-1
	1.2 Composting	1-1
	1.3 Bioremediation Using Composting	1-3
	1.4 Applicability of Composting for Explosives	1-4
	1.5 Umatilla Depot Activity	1-4
	1.6 Site Description and History	1-4
2	TEST OBJECTIVE/APPROACH	2-1
	2.1 Seeding Study Objective and Approach	2-1
	2.2 Windrow Study Objective and Approach	2-2
3	MATERIALS AND METHODS FOR SEEDING STUDIES	3-1
	3.1 Site Layout	3-1
	3.2 Static Tank Reactors	3-1
	3.3 Test Soil/Sediment	3-5
	3.4 Amendments and Recipe	3-5
	3.5 Materials Handling and Mixing Strategy	3-7
	3.6 Temperature	3-9
	3.6.1 Temperature Monitoring	3-9
	3.6.2 Temperature Control	3-9
	3.7 Oxygen	3-11
	3.7.1 Oxygen Monitoring	3-11
	3.7.2 Oxygen Control	3-11
	3.8 Moisture	3-12
	3.8.1 Moisture Monitoring	3-12
	3.8.2 Moisture Control	3-12
	3.9 pH	3-13
	3.9.1 pH Monitoring	3-13
	3.9.2 pH Control	3-13



TABLE OF CONTENTS
(Continued)

<u>Section</u>	<u>Title</u>	<u>Page</u>
3.10	Explosives Sampling	3-13
3.10.1	Sampling and Analysis	3-13
3.10.2	Sample Preparation and Analytical Procedure	3-15
3.11	Microbiological and Biochemical Testing	3-15
3.12	Safety	3-15
3.13	U.S. Army Biomedical Research and Development Laboratory (USABRDL)	3-15
3.14	Schedule	3-16
4	MATERIALS AND METHODS FOR WINDROW STUDIES	4-1
4.1	Site Layout	4-1
4.1.1	Uncontaminated Windrows	4-1
4.1.2	Contaminated Windrows	4-1
4.2	Containment Building	4-2
4.3	Windrow Turner	4-2
4.4	Test Soil	4-5
4.4.1	Uncontaminated Soil	4-5
4.4.2	Contaminated Soil	4-5
4.5	Amendments and Recipe	4-8
4.6	Construction of Windrows	4-10
4.7	Mixing of Windrows	4-10
4.7.1	Uncontaminated Windrows	4-10
4.7.2	Contaminated Windrows	4-12
4.8	Temperature	4-13
4.8.1	Temperature Monitoring	4-13
4.8.2	Temperature Control	4-16
4.9	Oxygen	4-19
4.9.1	Oxygen Monitoring	4-19
4.9.2	Oxygen Control	4-19
4.10	Moisture	4-19
4.10.1	Moisture Monitoring	4-19
4.10.2	Moisture Control	4-19
4.11	pH	4-20
4.11.1	pH Monitoring	4-20
4.11.2	pH Control	4-20



**TABLE OF CONTENTS
(Continued)**

<u>Section</u>	<u>Title</u>	<u>Page</u>
4.12	Windrow Supplementation	4-20
4.13	Sampling	4-20
	4.13.1 Uncontaminated Windrows	4-20
	4.13.2 Contaminated Windrows	4-20
4.14	Biochemical and Microbiological Testing	4-21
4.15	Supplemental Testing	4-21
	4.15.1 Oak Ridge National Laboratory (ORNL)	4-21
	4.15.2 Toxicity Studies	4-22
4.16	Safety	4-22
5	RESULTS	5-1
5.1	Results of Seed Studies	5-1
	5.1.1 Temperature	5-1
	5.1.2 Oxygen	5-6
	5.1.3 pH	5-6
	5.1.4 Moisture Content	5-6
	5.1.5 Microbiology Results	5-11
	5.1.6 Explosives Degradation	5-11
	5.1.7 Kinetics	5-23
5.2	Results of Windrow Studies	5-23
	5.2.1 Uncontaminated Windrows 1 and 2	5-23
	5.2.2 Uncontaminated Windrows 3 and 4	5-28
	5.2.3 Uncontaminated Windrows 5 and 6	5-33
	5.2.4 Contaminated Windrows 7 and 8	5-37
5.3	Supplemental Testing Results	5-61
	5.3.1 Analytical Method Comparison	5-61
	5.3.2 Oak Ridge National Laboratory	5-62
6	DISCUSSION	6-1
6.1	Seeding Study	6-1
6.2	Windrow Studies	6-2



**TABLE OF CONTENTS
(Continued)**

<u>Section</u>	<u>Title</u>	<u>Page</u>
7	LESSONS LEARNED	7-1
8	CONCLUSIONS	8-1
9	REFERENCES	9-1
APPENDIX A	SUPPLIERS/MANUFACTURERS/SPECIFICATIONS	
APPENDIX B	MOISTURE MEASUREMENT CALCULATIONS	
APPENDIX C	QA/QC PROCEDURES	
APPENDIX D	ANALYTICAL PROCEDURES	
APPENDIX E	HAZARD REVIEW OF KW WINDROW COMPOSTER	
APPENDIX F	RAW EXPLOSIVES, INTERMEDIATES, AND OXYGEN DEPLETION STUDY DATA	
APPENDIX G	GRAPHICAL PRESENTATION OF TNT REMOVAL KINETICS AND REGRESSION RESULTS	
APPENDIX H	COMPARISON OF EPA SW846 DRAFT METHOD 8330 AND USATHAMA METHOD LW02	

LIST OF FIGURES

<u>Figure No.</u>	<u>Title</u>	<u>Page</u>
1-1	UMDA Location Map	1-5
1-2	Overview of UMDA Layout	1-6
3-1	Seeding Study Site Layout	3-2
3-2	Composting Study Locations at UMDA	3-3
3-3	Schematic of a Typical Aerated Static Pile Reactor	3-4
3-4	Seeding Study Thermocouple Positions	3-10
3-5	Seeding Study Explosives Sampling Locations	3-14
3-6	Seeding Study Schedule	3-17
4-1	Contaminated Windrows Site Layout	4-3
4-2	Cross-Sectional Side View of Contaminated Windrow Site	4-4
4-3	Cross-Sectional View of Windrow	4-14
4-4	Windrow Monitoring Locations	4-15
4-5	Aeration System Diagram for Uncontaminated Windrow No. 5	4-17
4-6	Aeration System Diagram for Contaminated Windrow No. 7	4-18
5-1	Compost and Ambient Temperatures for Seeding Study A	5-2
5-2	Compost and Ambient Temperatures for Seeding Study B	5-3
5-3	Compost and Ambient Temperatures for Seeding Study C	5-4
5-4	Compost and Ambient Temperatures for Seeding Study D	5-5
5-5	Oxygen, Moisture, and pH Profiles for Seeding Study A	5-7
5-6	Oxygen, Moisture, and pH Profiles for Seeding Study B	5-8



**LIST OF FIGURES
(Continued)**

<u>Figure No.</u>	<u>Title</u>	<u>Page</u>
5-7	Oxygen, Moisture, and pH Profiles for Seeding Study C	5-9
5-8	Oxygen, Moisture, and pH Profiles for Seeding Study D	5-10
5-9	Explosives Concentrations Versus Time for Seeding Study A	5-15
5-10	Explosives Concentrations Versus Time for Seeding Study B	5-16
5-11	Explosives Concentrations Versus Time for Seeding Study C	5-17
5-12	Explosives Concentrations Versus Time for Seeding Study D	5-18
5-13	Percent Removal of HMX for Seeding Study	5-19
5-14	Percent Removal of RDX for Seeding Study	5-20
5-15	Percent Removal of TNT for Seeding Study	5-21
5-16	Uncontaminated, Unaerated Windrow (UWR1) with 10% Soil	5-24
5-17	Uncontaminated, Unaerated Windrow (UWR2) with 10% Soil	5-25
5-18	Oxygen Depletion Following Turning of UWR2	5-27
5-19	Uncontaminated, Unaerated Windrow (UWR3) with 20% Soil	5-29
5-20	Uncontaminated, Unaerated Windrow (UWR4) with 20% Soil	5-30
5-21	Temperatures After Supplementation of UWR4	5-32
5-22	Uncontaminated, Aerated Windrow (UWR5) with 30% Soil	5-35
5-23	Uncontaminated, Unaerated Windrow (UWR6) with 30% Soil	5-36
5-24	Contaminated, Aerated Windrow (CWR7) with 30% Soil	5-43
5-25	Contaminated, Unaerated Windrow (CWR8) with 30% Soil	5-44
5-26	Explosives Concentrations Versus Time for Windrow Study	5-48
5-27	Explosives Concentrations Versus Time (Semi-Log Scale)	5-50



**LIST OF FIGURES
(Continued)**

<u>Figure No.</u>	<u>Title</u>	<u>Page</u>
5-28	Percent Reduction of Explosives in Windrow Study	5-51
5-29	Intermediates Data — Contaminated, Aerated Windrow (CWR7)	5-55
5-30	Intermediates Data — Contaminated, Aerated Windrow (CWR7) (Logarithmic Scale)	5-56
5-31	TNT and Intermediates Data — Contaminated, Aerated Windrow (CWR7)	5-57
5-32	Intermediates Data — Contaminated, Unaerated Windrow (CWR8)	5-58
5-33	Intermediates Data — Contaminated, Unaerated Windrow (CWR8) (Logarithmic Scale)	5-59
5-34	TNT and Intermediates Data — Contaminated, Unaerated Windrow (CWR8)	5-60

<u>Table No.</u>	<u>Title</u>	<u>Page</u>
3-1	Hand-Excavated Seeding Study Soils Data	3-6
3-2	Seeding Study Compost Recipe (10% Soil)	3-8
4-1	Uncontaminated Windrow Soils Data	4-6
4-2	Contaminated Windrows Soils Data	4-7
4-3	Windrow Studies Compost Recipes	4-9
4-4	Physical and Chemical Properties of Initial Compost Mixture for the Contaminated Windrow Tests	4-11
5-1	Bacteria Population Levels for Seeding Study	5-12
5-2	Average Explosives Concentrations for the Seeding Study	5-13
5-3	Seeding Study 40-Day Explosives Removal and TNT Reaction Kinetics Summary	5-22
5-4	Bacteria Population Levels in UWR5 and UWR6	5-38
5-5	Bacteria Population Levels in CWR7 and CWR8	5-46
5-6	Average Explosives Concentrations for Contaminated Windrows	5-47
5-7	Windrow Study 40-Day Explosives Removal and TNT Reaction Kinetics Summary	5-52
5-8	Summary of Intermediates Data for Windrow Study	5-54
5-9	UMDA Compost Method Comparison	5-63
5-10	Comparison of Percent Reduction in Chemical/Toxicity Parameters in Contaminated Windrows Over 40 Days	5-64
5-11	CCLT Leachate Data for Windrow Studies	5-66
5-12	Concentration of Compost Leachate Required to Kill 50% of Test Organisms in 7 Days or to Lower Mean Reproduction to 15 Offspring per Female	5-67
5-13	Results for Ames Testing of Compost Acetonitrile Extracts	5-68

EXECUTIVE SUMMARY

The U.S. Army Environmental Center (USAEC), formerly the U.S. Army Toxic and Hazardous Materials Agency (USATHAMA), has conducted windrow and seeding composting field studies at the Umatilla Depot Activity (UMDA), located in Hermiston, Oregon. These studies were conducted between April and December of 1992 and represent the second phase of optimization field studies conducted at UMDA. The overall goal of these studies was to identify a composting technique that can provide an acceptable and cost-effective alternative to incineration for the treatment of explosives-contaminated soils.

The need for treatment of explosives-contaminated soils has resulted from past practices for manufacturing and handling explosives and propellants at Army industrial facilities. Disposal practices that were common and acceptable at the time of these operations have resulted in contamination of soils and sediments. Because of the potential for groundwater contamination and the migration of hazardous substances, treatment of the contaminant source may be necessary to protect the environment and avoid costly actions in the future. Treatment of soil can be labor-intensive and expensive when handling and transporting large volumes of material. In some cases, treatment methods, such as incineration, may be the only alternative. Where incineration is uneconomical or is not favored for other reasons, a less costly, environmentally acceptable solution needs to be developed, even if treatment requires a longer duration. A candidate for this type of treatment is composting.

Previous studies conducted by USAEC have demonstrated the susceptibility of explosives to microbial degradation. In particular, the previous UMDA study evaluated the effectiveness of mechanically agitated in-vessel (MAIV) and aerated static pile (ASP) composting systems. The process variables considered were soil loading percentages and compost mixture compositions. Based upon the results of these previous studies, the windrow and seeding composting studies were developed to further investigate potential composting methods that can be used for remediation of explosives-contaminated soils.

The seeding study portion of the current field studies investigated the usefulness of recycling a portion of active compost from one aerated static reactor into the initial mix of a subsequent reactor study. It was theorized that over time, an acclimated culture of organisms adapted for the biological degradation of explosives would be developed. The presence of such organisms in the compost mixture and their continual incorporation into successive mixtures could result in a significant decrease in the retention time necessary to reach explosives reduction goals.

The results of the static tank seeding studies conducted in this test did not show substantial differences in explosives breakdown between seeded tanks and control tanks in which no seed was used. All of the aerated static reactor studies exhibited greater than 90% reduction in 2,4,6-trinitrotoluene (TNT) within 40 days, with some tests reaching as high as 99.6% removal during this same period. Among the eight individual static tank tests conducted, four of the tests reached TNT concentrations below 30

mg/kg in the compost in 40 days, while the other four did not. None of the aerated static tank reactors exhibited hexahydro-1,3,5-trinitro-1,3,4-triazine (RDX) removal to less than 30 mg/kg in compost. While the principle of seeding and recycle is well-founded in waste treatment practice, clear benefits were not observed under conditions used in this study.

The windrow study investigated the feasibility of employing a windrow composting approach for the remediation of explosives-contaminated soils and sediments. All previous work prior to this test had employed either ASP or MAIV systems. Initially, the windrow study intended to evaluate soil loading percentages and turning frequencies by conducting six windrows containing uncontaminated soils to simplify operating requirements. The knowledge gained from these studies would be used to select the operating parameters for a final set of contaminated windrows. Following the completion of the first four sets of uncontaminated windrows, however, it was clear that the turning frequency was not a crucial operating parameter. In all cases, oxygen depletion in the windrow occurred soon after turning. Based upon these observations, the study was re-oriented to examine the need for and effect of supplemental aeration on the windrow operations. As a result, the turning frequency variable was omitted from the remaining studies in favor of a constant daily turning frequency, and the effectiveness of forced supplemental aeration was evaluated in the final studies. For both the last set of uncontaminated windrow studies and the contaminated windrow study, one of the two windrows in each set was constructed over a bed of wood chips in which a series of perforated pipes was set. The pipes were connected to mechanical blowers that then provided aeration to the compost for both oxygenation and heat removal. The second windrow in each set did not incorporate supplemental aeration.

The results of the windrow study indicate that, based upon temperature, the inclusion of the aeration system is generally beneficial to heating of the windrow. The aerated piles exhibited higher operating temperatures and produced less odor. However, it is also possible that the pile may have cooled sooner as a result of more rapid depletion of organics and increased heat removal in the presence of additional air. With respect to explosives degradation, however, the unaerated windrow showed equal, or better, removal of the explosives octahydro 1,3,5,7-tetranitro-1,3,5,7-tetrazocine (HMX), RDX, and TNT than did the aerated windrow. Concentrations of TNT and RDX were reduced by greater than 99% in fewer than 40 days in both windrows and concentrations of less than 30 mg/kg were achieved. Furthermore, the windrow study confirmed the results of previous field studies, which indicated that a soil loading as high as 30% by volume is satisfactory for maximizing soil throughput while maintaining enough organic material to sustain sufficient microbial activity to produce self-heating of the compost and biological transformation of the explosives.

Preliminary analytical results indicate that concentrations of explosives and intermediates in Clean Closure Leaching Test (CCLT) extracts from compost samples of the contaminated windrows are significantly reduced by the end of the test. Furthermore, aquatic toxicity and mutagenicity data developed in separate USAEC test programs show similar reductions.



Overall, the windrow and seeding composting studies conducted at UMDA, along with the previous composting field studies, have shown that windrow composting is a viable treatment alternative for the remediation of explosives-contaminated soils and sediments. The studies showed that the windrow composting provided better removal of explosives than the aerated static pile composting. In addition, the unaerated windrow exhibited more efficient removal of explosives than the aerated windrow.

The purpose of this report is to summarize all procedures and activities associated with the windrow and seeding composting studies and to clearly present the data obtained. In addition, the results and conclusions drawn from these data are presented, along with a discussion of individual tests in the study.

BACKGROUND INFORMATION

The purpose of this section is to provide important information necessary to the understanding of the composting technology and to specific characteristics of the UMDA site.

1.1 NATURE OF THE PROBLEM

The manufacturing and handling of explosives and propellants at Army Ammunition Plants (AAPs) and Army Depots (ADs) has resulted in contamination of soils and sediments as a result of disposal practices that were common and acceptable at the time of operation. Because of the potential for groundwater contamination and the migration of hazardous substances, treatment of the contaminated source may be necessary to protect the environment and avoid costly actions in the future. Treatment of soil can be labor-intensive and expensive when handling large volumes of materials. In some cases, treatment methods, such as incineration, may be the only alternative. Where incineration is uneconomical or is not favored for other reasons, a less costly, environmentally acceptable solution needs to be developed even if treatment requires longer duration. A candidate of the latter type is composting.

1.2 COMPOSTING

Composting is a process by which organic materials are biologically degraded by microorganisms such as bacteria and fungi, resulting in the production of organic and/or inorganic by-products and energy in the form of heat. The heat produced by the microorganisms is trapped within the compost matrix, leading to an increase in compost temperatures. These higher temperatures result in accelerated metabolism, which in turn creates more heat, raising temperatures even further. In this way, a positive feedback loop is developed that creates a "self-heating" condition, which can result in compost temperatures above 70 degrees Celsius (°C). Temperatures above this level may inhibit microorganisms and lead to a decline in metabolic activity. In this sense the process also has self-regulating properties in terms of temperature.

The temperature of the compost dictates the types of microorganisms that will dominate. In the temperature range of approximately 35 to 45 °C, a group of microorganisms referred to as mesophiles will dominate in the compost. As the compost temperature increases to approximately 50 to 60 °C, the mesophiles decline and a second group of organisms referred to as thermophiles (meaning "heat lovers") will predominate [4]. In the past, the term "composting" has often implied operation under thermophilic conditions; however, more recently, the application of composting technologies to industrial wastes has broadened the definition to include mesophilic conditions.

Another characteristic that helps define the microbial populations within the compost is the presence or absence of oxygen within the matrix. Certain microorganisms,

referred to as aerobes, flourish when oxygen is present. Others, referred to as anaerobes, survive in an oxygen-free environment. Within a compost matrix, however, both aerobic and anaerobic environments may exist simultaneously, as a result of very small individual environments called microsites in which oxygen may or may not be present. The existence of both aerobic and anaerobic microsites within compost helps create a very diverse microbial population. While aeration of a compost pile may favor aerobes by reducing the number of oxygen-free microsites within the matrix, the anaerobes may not be completely eliminated.

In part, the emphasis on thermophilic conditions for composting is based upon the performance goals for composting of wastewater treatment plant sludge, which include pathogen reduction and drying in addition to stabilization of organic matter. The goals for treatment of industrial or hazardous wastes may be quite different from those for sewage sludge and may result in different criteria for success [6].

The composting process is applicable to most biodegradable compounds as long as the concentration of organic matter is sufficient to maintain a high metabolic rate, and as long as the physical insulating properties of the compost are such that the heat evolved by the breakdown of the organics is trapped within the compost matrix.

Composting is typically implemented at one of three general levels of technology. These levels differ in the degree of manipulation required and process control attained. Consequently, costs increase at higher technological levels. At the simplest technological level, the material to be composted is shaped into the form of a pile and allowed to self-heat. If needed, water and nutrients may be added. At this level air exchange is relatively poor, and temperatures may fluctuate widely throughout the composting material. Aeration may be increased by periodically turning the pile; however, process control remains limited unless the piles are turned with a frequency based upon an operating parameter, such as temperature. This level of technology is often referred to as a "windrow" system, because of the long, narrow rows of compost typically used.

At the next technological level, an aeration/heat removal system is used to increase process control over the composting system. The aeration/heat removal system typically takes the form of a network of perforated pipe underlying the compost pile. The pipe is attached to a mechanical blower, and air is periodically drawn or forced through the compost to provide aeration and heat removal. This composting configuration is often referred to as an "aerated static pile." This type of system provides better temperature control than an ordinary static pile or windrow system; however, because the compost is not regularly mixed in these systems, it is possible for the compost to develop inconsistencies in temperature, moisture, pH, or other parameters.

At the highest level of technology and process control, a system of enclosed composting vessels and automated materials handling equipment is used to produce a continuous treatment process. The systems possess both mechanical mixing and aeration/heat removal equipment. This type of system is often referred to as "in-vessel" composting.

While these generalities regarding technology levels are useful rules of thumb, they must be used with caution. In some cases, the terms used to describe the system may be misleading, for example, static pile composting can be conducted in vessels or in windrows. Also, a combination of technologies may be used in a single composting operation. For example, a mechanically mixed windrow system can be fitted with an aeration/heat removal system to significantly increase process control.

1.3 BIOREMEDIATION USING COMPOSTING

In the past, composting has been used in the treatment of municipal solid waste, agricultural wastes, and wastewater treatment plant sludges. The objective of solid waste composting is to reduce the volume of refuse that needs to be disposed of in a landfill by biologically degrading the organic portion of the waste. For wastewater treatment plant sludges, there are several additional objectives of composting, including reduction of volume, reduction of moisture content, destruction of odorous nitrogen and sulfur-containing compounds, and destruction of pathogenic organisms.

Because sludge and municipal solid waste are produced continuously, composting systems designed for their treatment must provide for a rapid turnover of incoming wastes if they are to operate efficiently. This is because the rate of processing must approximate the rate of waste loading to avoid an accumulation of the waste material. The rate of waste generation is fixed by factors specific to the waste source, and determines the size of the composting operation.

The composting of hazardous materials has only recently become a treatment alternative. Unlike municipal waste and wastewater sludge composting, the primary objective for hazardous waste composting is to convert the hazardous constituents into innocuous end products for final disposal. Typically, there is a fixed quantity of the target material, and although rapid processing is desirable, it usually is secondary to the successful treatment of the contaminants.

Consequently, the biotransformation kinetics for the target constituents, rather than general criteria with respect to temperature or other nonspecific operating parameters, govern the required treatment period for hazardous wastes. Furthermore, the need for efficient treatment to meet specific (numerical) cleanup criteria suggests a greater emphasis on process control and homogeneity.

Another major difference between solid waste and sludge composting, and composting of hazardous materials is that the medium in which the hazardous compounds reside is not necessarily compostable by itself. For example, soils that have been contaminated with organic compounds cannot be composted in their natural form because soil does not typically contain sufficient organic matter to maintain the self-heating necessary to develop a composting system. As a result, additional organic sources or "amendments" may be added to the soil to create a suitable composting environment.

1.4 APPLICABILITY OF COMPOSTING FOR EXPLOSIVES

Previous studies have demonstrated the susceptibility of explosives and propellants to microbial degradation. Routes of bioconversion, intermediates, products, and analytical methods to assess the results have been determined in laboratory scale testing [5]. Successful field scale composting of the explosives TNT and RDX in soil has been conducted as well [1, 5]. Separate testing has shown that nitrocellulose in soils can be treated by composting [7]. Biodegradation mechanisms are known for some of their manufacturing byproducts and for the nitrate ester propellants. Composting of these energetic compounds has been conducted on a pilot scale in reactor vessels sufficiently large to simulate field conditions [1, 5, 7].

1.5 UMATILLA DEPOT ACTIVITY

UMDA is an active Army facility located on nearly 20,000 acres (approximately 23 square miles) in northeastern Oregon's Umatilla and Morrow counties (see Figure 1-1). The depot is located in a semi-arid environment where annual precipitation and evaporation are 9 and 32 inches, respectively. Primary population centers within a 6-mile radius of UMDA include Hermiston (population 9,870), Umatilla (population 3,120), and Irrigon (population 865).

UMDA was originally purchased by the U.S. Army in 1940 and was established as an ordnance depot for storing conventional munitions. The functions of the depot were extended to include ammunition demolition (1945), renovation (1947), and maintenance (1955). In 1962, the storage of chemical munitions began at UMDA. In August 1973, the installation was redesignated as an Activity by the U.S. Army Materiel Command. UMDA continues to be used to store chemical and conventional munitions in igloos on-site.

In 1986, the U.S. Environmental Protection Agency (EPA), Region 10 conducted a Resource Conservation and Recovery Act (RCRA) Resource Facility Assessment (RFA) to identify releases or potential releases from various solid waste management units (SWMU) or spill sites at UMDA. Based upon this assessment, EPA advised USAEC to collect additional information so that proper corrective measures could be formulated for selected SWMUs. Meanwhile, a SWMU known as the explosives washout lagoons area (Figure 1-2, Area 1) had been placed on the National Priorities List (NPL) because of the presence of explosives in the water table aquifer.

1.6 SITE DESCRIPTION AND HISTORY

The explosives washout operation, formerly conducted in Building 489, involved the removal of explosives from munitions, bombs, and projectiles by means of water and/or steam-cleaning techniques. Some of the munitions demilitarized at this location included 500 and 750-pound Composition B (60% RDX, 40% TNT) bombs and 90-mm projectiles. The washout operations included sizable amounts of Composition B and TNT. During the life of the washout plant, sludges built up in the prerinse tanks. These sludges were removed as necessary and placed in the washout tank. Sludges that

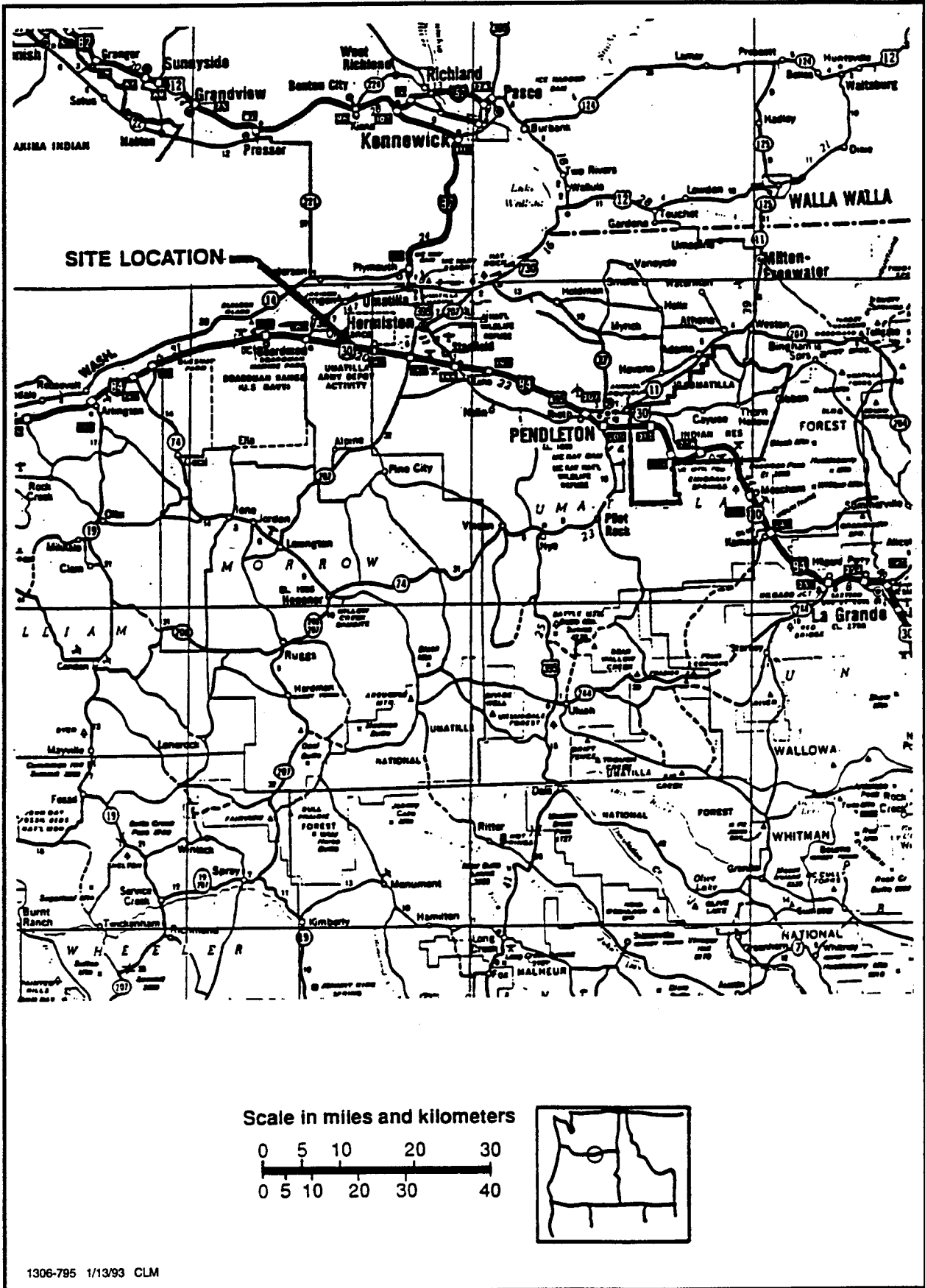

1306-795 1/13/93 CLM

FIGURE 1-1 UMDA LOCATION MAP

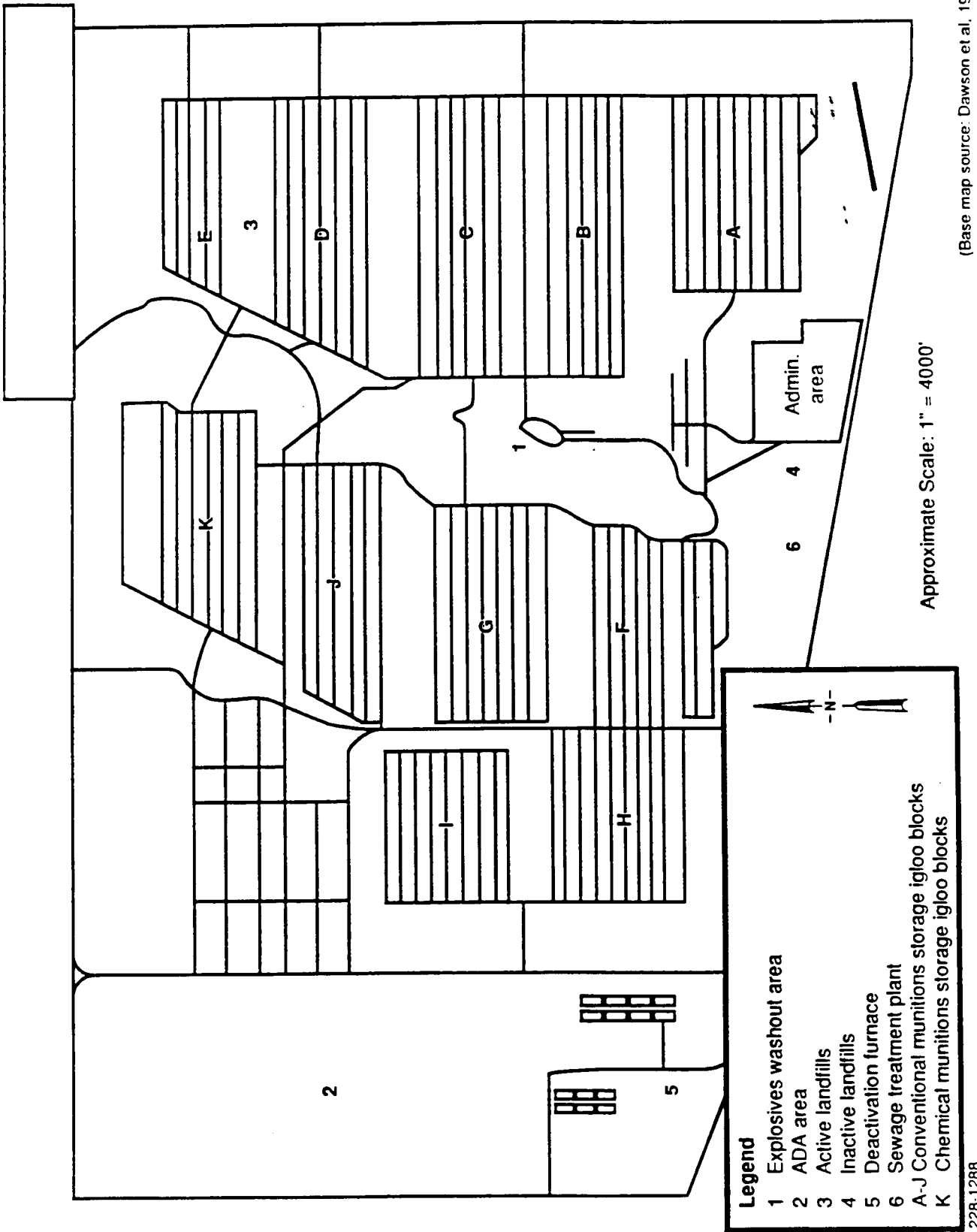

(Base map source: Dawson et al, 1982)

Approximate Scale: 1" = 4000'

Legend

- 1 Explosives washout area
- 2 ADA area
- 3 Active landfills
- 4 Inactive landfills
- 5 Deactivation furnace
- 6 Sewage treatment plant
- A-J Conventional munitions storage igloo blocks
- K Chemical munitions storage igloo blocks

228-1288

FIGURE 1-2 OVERVIEW OF UMDA LAYOUT

accumulated in the washout tank were pumped to the reclaiming operation. Explosives in the washout tank sludges were separated from the water, concentrated, dried, formed into pellets, and packaged for resale. Liquors from the reclaiming operation were returned to the washout tank.

Excess wastewaters generated from the sump were conveyed by gravity flow in a trough to two infiltration lagoons (washout lagoons) located in Coyote Coulee. The trough is a steel, open top, three-sided drainage channel designed to minimize spills and leaks. Former UMDA washout building employees have indicated to USAEC that overflow from the trough occurred very infrequently and usually was caused by plugs of explosives accumulated in the trough. The entire explosives washout system was drained, flushed, and cleaned approximately once every week. The washout lagoons received all of the approximately 150,000 gallons of explosives-contaminated water generated weekly.

A concrete sump, located midway between the washout plant, Building 489, and the washout lagoons, served to settle out explosives particles/solids prior to discharge of process water to the lagoons. During washout operations, the concrete sump containing washwater solids was pumped two to three times per week into a 500-gallon tank. This tank was then transported to the ammunition demolition activity (ADA) area (see Figure 1-2, Area 2), where the contents were discharged into the northernmost burn trench.

The two washout lagoons were operated in an alternating manner. Washout wastewater (also known as pink water because of its characteristic color) was accumulated in one of the lagoons, while the waste in the other lagoon was allowed to dry. Wastewater was accumulated in a given lagoon until the depth was approximately 3.5 ft and/or the rate of infiltration was substantially reduced by accumulation of solids. The washout wastewaters was then directed to the other lagoon by a movable flume at the discharge end of the rectangular chute. After drying, the residual solids were transported to the ADA area for open burning.

Both of the washout lagoons are gravel-lined and occupy an total area of approximately 10,000 ft². The lagoons were operated from the mid-1950s until 1965, and it is estimated that a total of up to 85 million gallons of washout wastewater may have been discharged to the lagoons. Former UMDA employees have indicated that both lagoons have been rebuilt over the years.

TEST OBJECTIVE/APPROACH

The overall objective of the windrow and seeding composting studies conducted at Umatilla Depot Activity (UMDA) was to expand upon the data necessary to implement composting as an acceptable and cost-efficient alternative to incineration for the treatment of explosives-contaminated soils and sediments. As such, the study involved two principal components. One of these components was the evaluation of an alternate operating strategy using compost recycle to increase the rate and/or extent of explosives transformation. The second component evaluated windrow composting as an alternative to the ASP and MAIV systems used in the previous study [1]. As part of these tests, the study also evaluated several composting parameters that have the potential to increase soil throughput, which is the quantity of soil processed per unit time. Two composting process variables exist that can significantly affect the throughput attained in a composting system. The first is the amount of contaminated soil included in the compost mixture. The second is the rate at which the explosives are transformed to innocuous end products. Based upon literature review and the results of previous field studies at UMDA, the windrow and seeding composting studies were intended to optimize soil throughput by maximizing these two process variables. The specific objectives and general approach for each of the studies are presented below.

2.1 SEEDING STUDY OBJECTIVE AND APPROACH

The objective of the seeding study was to determine whether the recycling of a small percentage of active compost from one treatment cycle into the initial mixture of a subsequent cycle would result in improvement in the rate or extent of explosives removal in the compost system. Conceivably, this would result from an increase in the rate of heating, a reduction in the time required by the organisms to become acclimated to their new environment (i.e., microbial lag phase) and/or an increase in the transformation rate through the development of a specialized microbial population, thereby reducing the overall retention time necessary to attain explosives reduction goals.

The seeding study was implemented by conducting sequential composting trials, using aerated static pile tank reactors. Four consecutive 40-day tests, referred to as Test A, Test B, Test C, and Test D, respectively, were conducted. For each test, two tanks were used, with one being designated the control tank (e.g., Control A), and the other designated as the seed tank (e.g., Seed A). The compost was mixed freshly on Day 0 of each test and then loaded into the respective tanks. Both tanks in each test were treated identically, with the exception that during the loading of seed tanks B through D, a portion (5% by volume) of the active compost from Day 20 of the previous seed test was incorporated into the new seed tank compost mixture. Both tanks were then operated and maintained similarly, with compost samples being taken on days 0, 10, 20, and 40, and analyzed for the explosives TNT, HMX, RDX, 1,3,5-Trinitrobenzene (TNB),

and dinitrotoluenes (DNTs). Details of the operation are provided in Section 3: Materials and Methods for Seed Studies.

2.2 WINDROW STUDY OBJECTIVE AND APPROACH

The objective of the windrow composting studies was to evaluate the potential of using a windrow composting system to treat explosives-contaminated soils. In general, windrow composting is the simplest of the three basic composting systems in terms of equipment and operation. Therefore, windrow composting, if feasible for soils, offers the potential for low cost treatment. As a result, the intention of this study was to determine whether composting of soil could be achieved and controlled under windrow conditions and to optimize the operating parameters that could affect the throughput of the windrow composting system. Such parameters may include mixing frequency, soil loading rates, and aeration requirements. Upon identifying the optimal operating conditions based upon temperature profiles for uncontaminated soils, the final objective of the study was to demonstrate that the windrow technology would provide sufficient removal of explosives, when contaminated soils were used.

The initial design of the test was to conduct three sets of uncontaminated windrow composting tests, while operating two windrows within each set. Within each set, one windrow was to be mixed daily, while the second windrow was to be mixed three times per week. Between sets, the variable under consideration would be soil loading percentage, with the first set operating at 10% soil by volume, the second set operating at 20% soil by volume, and the third and final set operating at 30% soil by volume. Typical composting operating parameters (primarily temperature, along with oxygen level, pH, and moisture) were used to assess whether effective thermophilic composting could be achieved under these test conditions. Based upon the results of these preliminary tests, a combination of operating conditions (turning frequency and soil loading) would be selected to be used in one set of contaminated windrow studies.

Upon completion of the first two sets of uncontaminated windrows, however, it became apparent that the turning frequency was not effective in maintaining high interstitial oxygen levels in the compost over the range of frequencies tested. Oxygen measurements taken during the first two sets of windrow studies indicated that oxygen levels within the piles dropped rapidly to low levels shortly after mixing. Because all previous composting work for explosives employed highly aerobic conditions, it was decided that the need for and effectiveness of, forced aeration as a supplement to windrow turning would be evaluated in the third set of windrows. The final uncontaminated compost windrows were constructed with 30% soil as originally designed. However, one of the piles was constructed over a bed of wood chips in which was set a series of perforated pipes. These pipes were connected to blowers, which provided aeration on a periodic basis for oxygenation and as necessary to cool the pile to desired operating temperatures. The second windrow did not employ supplemental aeration and relied solely upon turning for reoxygenation. The turning frequency variable was eliminated in favor of a daily turning for both piles, after it was determined that the maximum turning frequency that could reasonably be achieved in a full-scale operation would be once per day.

Finally, the operating conditions of the third set of uncontaminated windrows were incorporated into the contaminated windrow test, in which explosives contaminated soil was substituted for the uncontaminated soil used previously. Again, both windrows were constructed at 30% soil by volume and were mixed daily. One pile was provided with an aeration system while the other was not. Samples were taken from each windrow on days 0, 5, 10, 15, 20, and 40 and analyzed for TNT, HMX, RDX, TNB, DNTs (explosives) and the two amino-dinitrotoluenes (2A-4,6 DNT and 4A-2, 6 DNT) and the two diamino-nitrotoluenes (2,4DA-6NT and 2,6DA-4NT) (intermediates) to confirm that degradation of the target compounds was occurring.

The final set of uncontaminated windrows and the subsequent contaminated windrow tests thus provided direct performance comparison between high and relatively low oxygen levels in terms of both conventional composting parameters and explosives removal efficiency. Further details on the operation of both the contaminated and uncontaminated windrows are provided in Section 4: Materials and Methods for Windrow Studies.

MATERIALS AND METHODS FOR SEEDING STUDIES

3.1 SITE LAYOUT

The seeding study was conducted using the aerated static pile tank reactors used in the previous optimization study [1]. These tanks were enclosed in a large greenhouse adjacent to the washout lagoons to protect the tanks and the associated electronic equipment from rain and windblown dust. To prevent the greenhouse from overheating during the summer months, a shade cloth was placed over its outer surface. In addition, two exhaust fans were installed at opposite ends of the greenhouse to provide further cooling and ventilation. Figure 3-1 presents a schematic diagram of the seeding study site. A decontamination tank was used to collect waters generated from the washing of personnel and equipment after conducting activities within the work area. The tank was placed in the ground, and two steel beams were placed over the tank at ground level so that the backhoe could be washed before removing it from the work area. Figure 3-2 illustrates the location of the seeding study site with respect to the washout lagoons and the uncontaminated/contaminated windrowing sites.

In support of all project field activities, a tool shed and an office trailer were placed on-site. The tool shed was used to store sample bottles, work tools, personal protective equipment, and other supplies necessary for the operation of the site. All flammable fuels, epoxies, and glues were stored in a separate cabinet outside of the tool shed.

The office trailer was divided into two rooms with a door in between. One room served as an office while the second room was set up as an on-site laboratory. Equipment used in the laboratory consisted of a balance, pH meter, oven, freezer, and various reagents, including distilled water, hydrochloric acid, ammonium hydroxide, and pH buffer solutions.

3.2 STATIC TANK REACTORS

The aerated static pile tank reactors used in the seeding study were the same tanks used in the previous optimization studies conducted at UMDA [1]. These 500-gallon fiberglass tanks were fitted with two air inlet ports to help distribute air evenly. To further distribute the air in the tank, the bottom of the vessel was filled with 6 inches of wood chips and then covered with a perforated wooden platform to prevent mixing of the wood chips with the compost. A hole in the side of the tank near the top provided a port for inserting the monitoring thermocouples. A series of spring clamps were used to fasten the lids to the tanks. Each tank was covered with 3 inches of fiberglass insulation to minimize heat loss from the tank. Figure 3-3 presents a schematic diagram of the aerated static pile reactors.

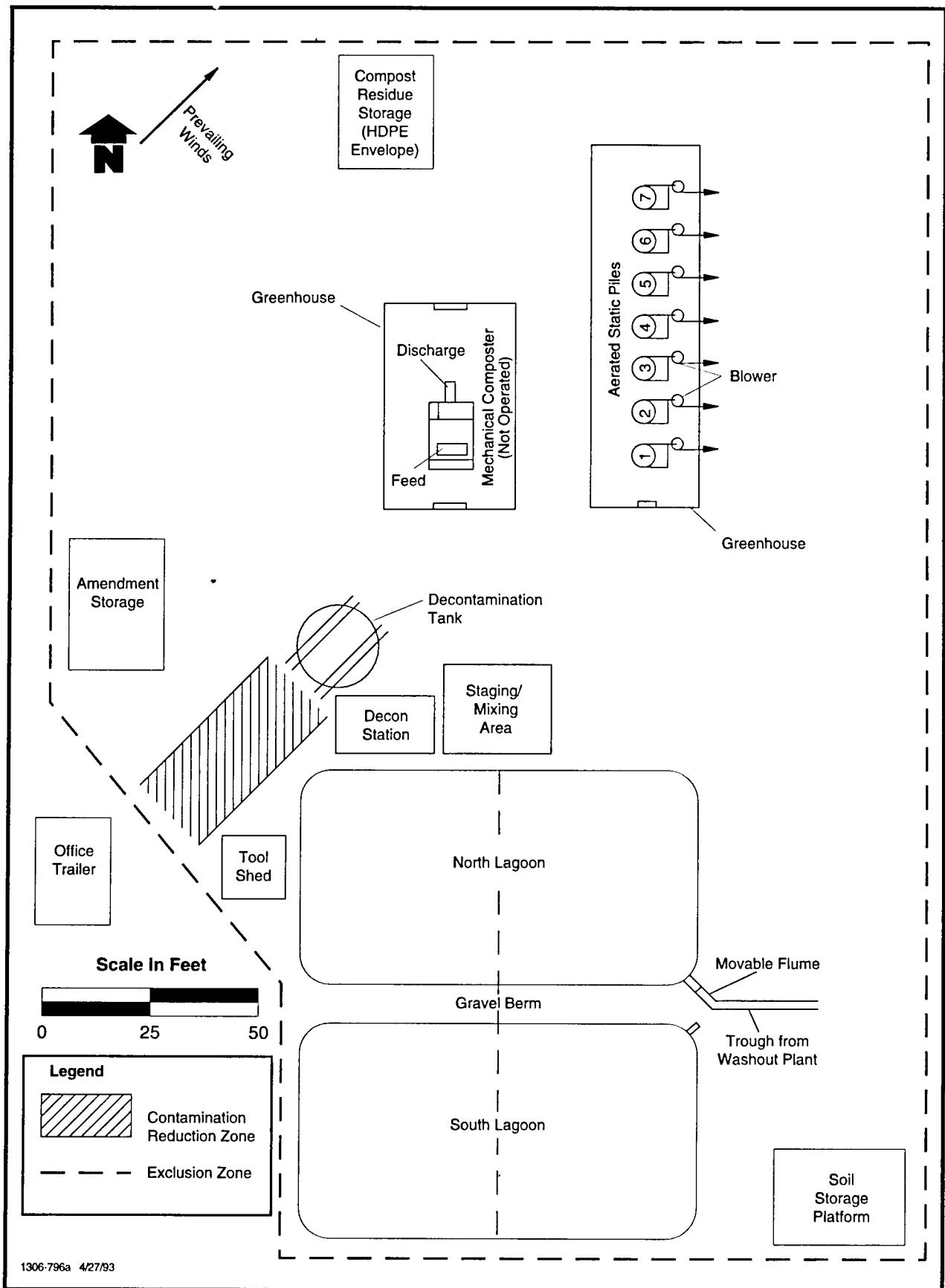

FIGURE 3-1 SEEDING STUDY SITE LAYOUT

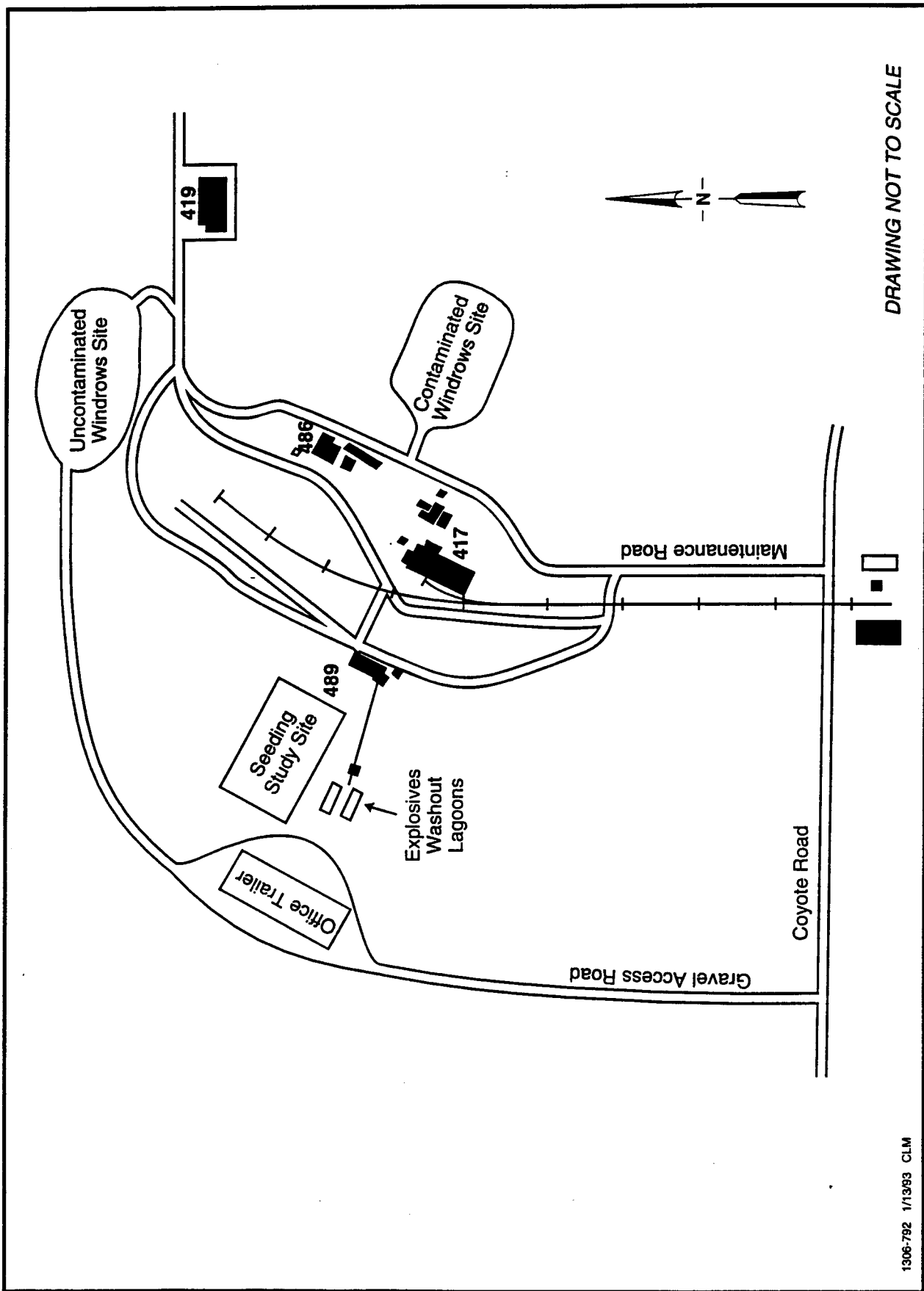
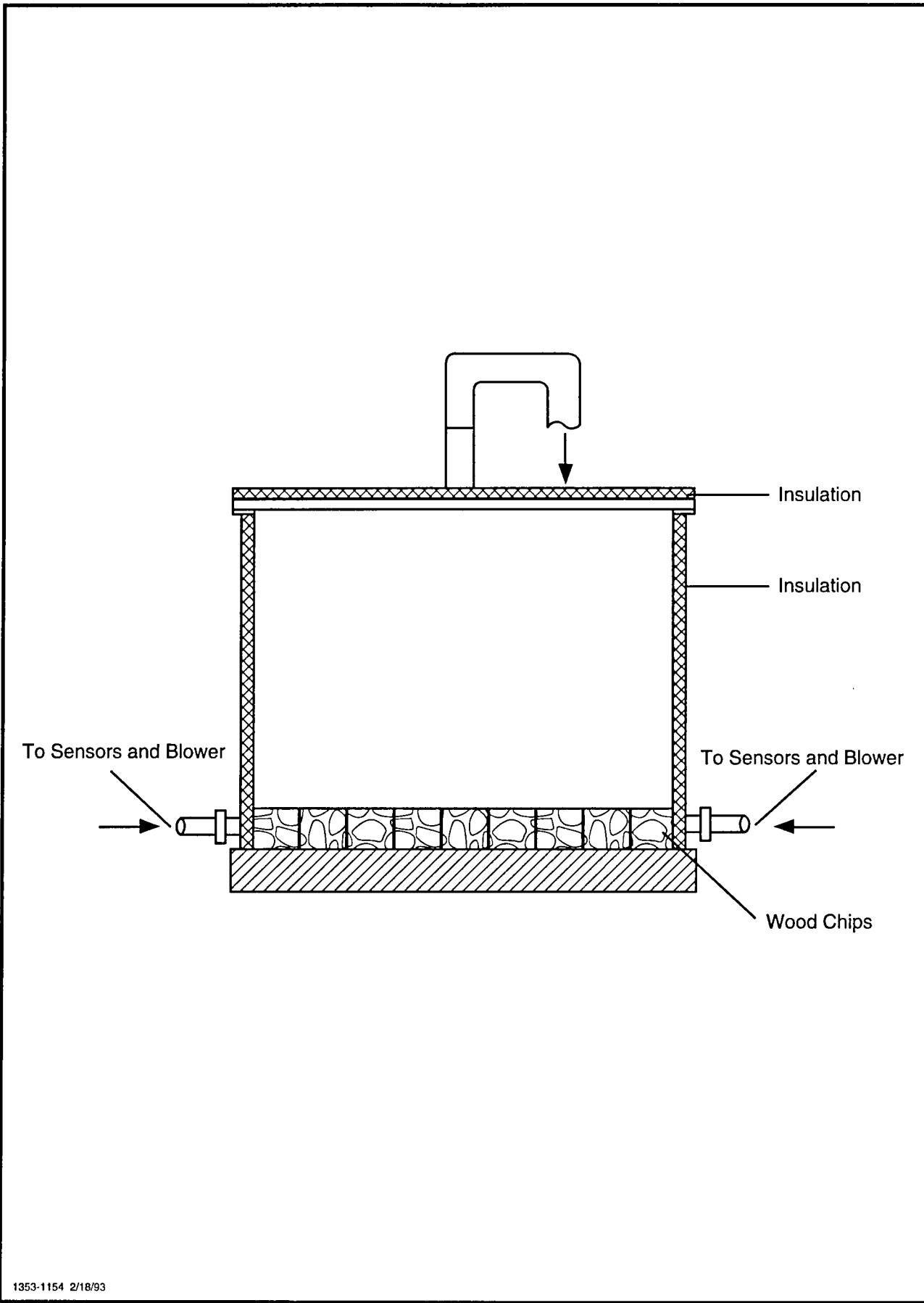

FIGURE 3-2 COMPOSTING STUDY LOCATIONS AT UMDA



1353-1154 2/18/93

FIGURE 3-3 SCHEMATIC OF A TYPICAL AERATED STATIC PILE REACTOR

3.3 TEST SOIL/SEDIMENT

The contaminated soil necessary to conduct the seed study was excavated by hand with shovels from the sidewalls of the washout lagoons. Hand excavation was performed to ensure that the soil used in the seeding studies would contain sufficient explosives concentrations for testing purposes. Hand excavation allowed careful selection of apparent "hot spots," where explosives compounds were more concentrated. The soil was screened directly into the bucket of a front-end loader to remove rocks and gravel. The loader was then used to transport the soil to the soil storage platform. Following homogenization with the backhoe, five random samples of this soil were sent to the analytical lab for explosives analysis. The analysis results for this soil are presented in Table 3-1.

The initial plan was to incorporate this soil directly into the compost mixture. However, the results of laboratory analysis indicated that the concentrations of TNT in the soil were on the order of 30,000 ppm, which exceeded the desired starting TNT concentration of approximately 20,000 ppm. This desired starting concentration was based upon estimates of the explosives concentrations to be expected for the full-scale remediation of the washout lagoons, so that results obtained for these studies would be indicative of the potential results in a full-scale composting system for these soils. As a result, additional soil was excavated and screened from the bottom of the northernmost washout lagoon to dilute these more concentrated soils. The explosives concentrations in these "dilution soils" were not determined through laboratory analysis. It was believed that these soils contained minimal concentrations of explosives. The actual blending of the two soils occurred during preparation of the compost mixture (see Section 3.5).

3.4 AMENDMENTS AND RECIPE

Prior to the previous field optimization studies at UMDA, an in-depth study was conducted by WESTON and the Woods End Research Laboratory to identify potential amendment sources in the vicinity of UMDA, and to develop a workable "compost recipe", taking into consideration such factors as pH, carbon to nitrogen (C:N) ratio, moisture content, homogeneity, seasonal availability, cost, total metabolic energy content, rate of carbon substrate use, texture, form, and porosity. Additional recipe formulation work was conducted for this study because of changes in the availability of amendment materials. Bench-scale testing was conducted to identify the best combination and proportions of available amendments using an adiabatic composter to evaluate the temperature profile and respiration rates of each compost mixture. Once a recipe was selected, further studies were conducted to assess the effect of different soil loading rates on compost heating performance. The results of the tests showed excellent heating performance at all soil loading rates (0%, 10%, 20%, and 30% soil by volume). Although the studies indicated better heating performance with decreasing soil loading, the observed respiration rates per unit of carbon were similar among the samples tested. This indicates that within a range of soil loading of 0% to 30% soil by volume, degradation rates are likely to be consistent. Details of the selection criteria and compost recipe formulation process will be presented in a separate report. Based

**Table 3-1
Hand-Excavated Seeding Study Soils Data**

Sample No.	2,4,6-TNT (µg/g)	RDX (µg/g)	HMX (µg/g)	1,3,5-TNB (µg/g)	2,6-DNT (µg/g)	2,4-DNT (µg/g)
006	31,700	8,270	1,720	65.80	7.97U	22.80
007	33,300	9,060	1,960	68.10	8.19U	23.70
008	31,100	9,000	1,920	66.80	7.97U	24.40
009	30,400	8,410	1,750	65.10	7.90U	23.30
010	26,000	11,200	2,700	61.80	8.10U	19.30
Average	30,500	9,188	3,010	65.52	4.01	22.70

U = Analyzed, Not Detected. Value presented is the lower detection limit.

Note: For calculation of average concentrations, J-Values and one-half of the lower detection limit presented for U-Values have been used.

on this testing and on the results of the previous MAIV and ASP field studies, a recipe was developed for the windrow and seeding studies conducted at UMDA.

The recipe developed for the seeding studies incorporated a soil loading rate of approximately 10% by volume as specified in the Test Plan. The remaining 90% of the volume was composed of the selected amendment mixture, including sawdust, alfalfa, cow manure, chicken manure, and potato processing wastes. These amendments were obtained fresh from local suppliers (see Appendix A) prior to the preparation of each set of tests and staged within the exclusion zone at the washout lagoons. Table 3-2 presents the volumes and percentages of amendments necessary to prepare one tank of compost.

3.5 MATERIALS HANDLING AND MIXING STRATEGY

The measurement and transport of amendments and soil in the preparation of compost for the seeding studies was accomplished through the use of a front-end loader. The capacity of the loader bucket was measured with known volumes of water and determined to be 0.5 yd³. In addition, 0.1 yd³ graduations were marked on the bucket with tape to provide further accuracy of measurement.

The mixing of compost for the seed studies was accomplished by combining the amendments within a large mixing box adjacent to the washout lagoons (see Figure 3-1) and then homogenizing the mixture with the backhoe. A total of approximately 6 yd³ of compost was mixed at the beginning of each set of studies to provide enough compost for the seed tank and the control tank. Several mixing strategies were attempted; the procedure that empirically provided the best results was as follows:

- Place alfalfa (hay) bales within the mixing box and remove binding twine.
- Break up bales by hand using pitchforks.
- Add sawdust, cow manure, chicken manure, and potatoes.
- Mix compost with the backhoe until it appears homogenous.
- Combine the 30,000-mg/kg TNT soil and the "dilution" soil in a 60:40 ratio by volume within the loader bucket and homogenize by hand using shovels.
- Add the soil to the compost mixture.
- Add water manually with hose to reach desired moisture content, based on a visual assessment of compost consistency.
- Mix compost very well with backhoe to ensure homogeneity.

Table 3-2**Seeding Study Compost Recipe (10% Soil)**

Ingredient	Volume (yd³)	Volume (%)
Sawdust	0.7	22.6
Alfalfa (Hay)	0.7	22.6
Chicken Manure	0.1	3.2
Cow Manure	0.9	29.0
Potatoes	0.4	12.9
Contaminated Soil	0.3	9.7
Totals	3.1	100

Once the compost was well mixed, the front-end loader was used to shuttle the compost to the control tank where the compost was off loaded into the tank by hand. This same procedure was used to fill the seed tank, except that before loading the tank, a portion of the active compost from the previous seed study was incorporated into the mixture.

This was done by first removing the seed compost from the active study and mixing it into the remaining 3 yd³ of newly prepared compost within the mixing box. The resulting compost mixture, containing 5% recycled seed compost by volume was then placed within the seed reactor.

Upon completion of each static tank test, the spent compost was unloaded by hand into the front end loader and transported to the high-density polyethylene (HDPE) envelope used to contain the spent compost (see Figure 3-1).

3.6 TEMPERATURE

3.6.1 TEMPERATURE MONITORING

Temperature monitoring within the static tanks was accomplished through the computerized data acquisition, management, and control system developed for the previous study [1]. Five J-type thermocouples were buried within the compost in each reactor as the tanks were being filled. The locations of the thermocouples were as follows:

<u>Thermocouple</u>	<u>Location in Tank</u>
1	Bottom/center
2	Middle/center
3	Top/center
4	Bottom/outside edge
5	Top/outside edge

The above positions are presented graphically in Figure 3-4 and were the same for all tests except Control A, in which the positions of thermocouples 2 and 3 were inadvertently reversed.

Temperatures within the tanks were logged directly into the computer's hard disk drive every half hour. In addition, hourly and daily summary reports were printed automatically to provide a hard copy of these temperatures.

3.6.2 TEMPERATURE CONTROL

Control of the temperature of the compost within the static tanks was maintained by the temperature feedback/process control system, which was an integral part of the computerized data acquisition, management, and control system. The average temperature in each tank was automatically calculated and compared to the set value of 55 °C. During initial warmup and under normal operating conditions, the blowers

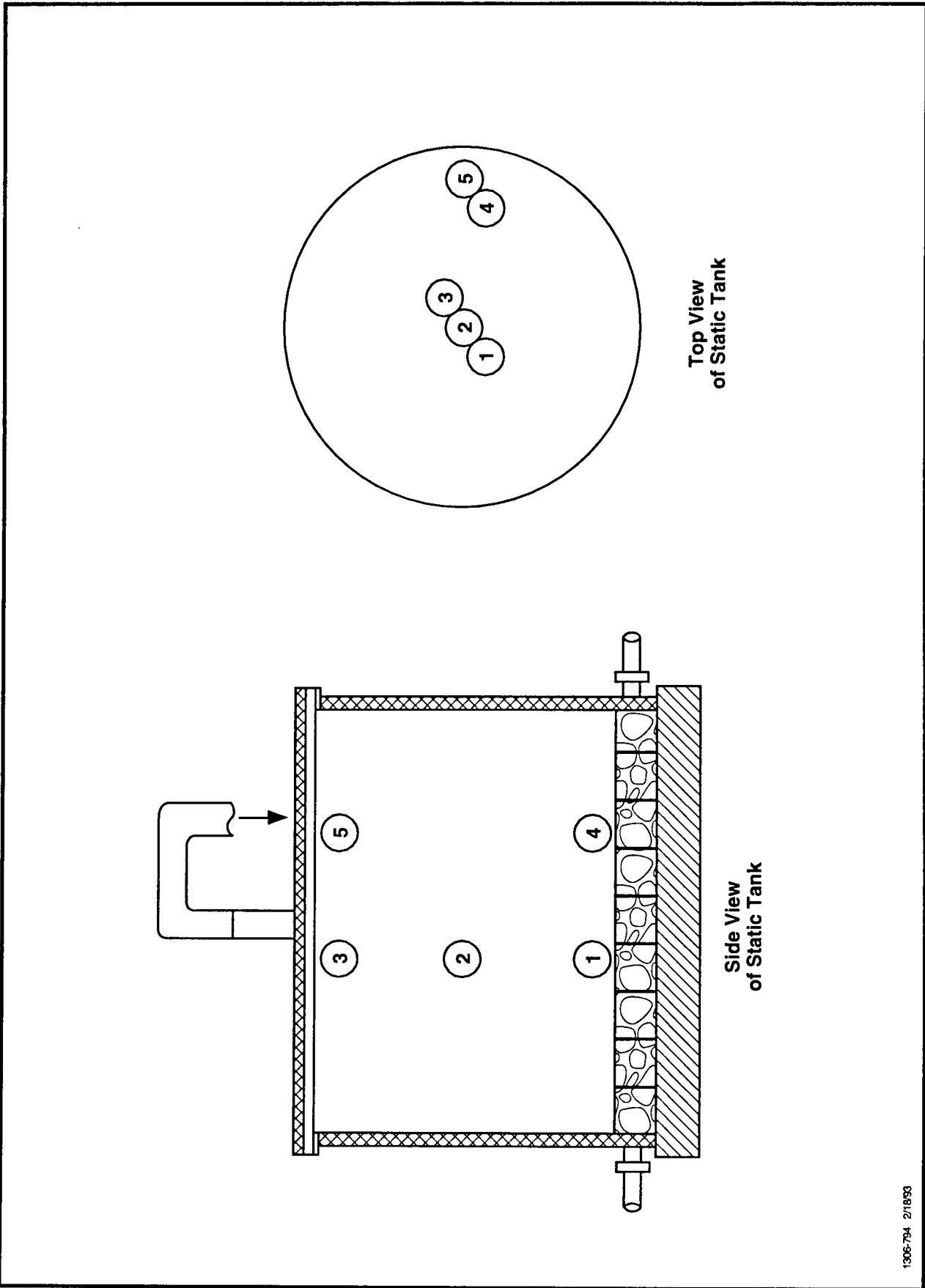

FIGURE 3-4 SEEDING STUDY THERMOCOUPLE POSITIONS

1306-794 2/1993

were controlled by the "oxygen demand timer," which was set to provide 8 seconds of aeration every 15 to 20 minutes. When the average temperature in the tanks reached 2 degrees above the set point (i.e., 57 °C), control was passed to a second timer referred to as the "cooling timer." The cooling timer was set for 30 minutes of blower operation with 1.5 minutes of off-time between cycles. Typically, only a few minutes of operation in this mode was necessary to cool the compost. Once the temperature dropped 2 degrees below the set point (i.e., 53 °C), control again was passed to the "oxygen demand timer." The system was also equipped with a backup alarm setting which provided constant operation of the blowers if the average temperature reached 60 °C.

Occasionally, corrosion of the thermocouples would cause malfunctions of individual thermocouples within a particular tank. Such occurrences were typically indicated by zero temperature readings on the system monitoring screen of the computer. When discovered, this problem was easily corrected by eliminating the thermocouple from the average temperature calculation. Until discovered, however, the erroneous average value would affect temperature control in the tank.

3.7 OXYGEN

3.7.1 OXYGEN MONITORING

Interstitial oxygen measurements within the compost in the static tanks were taken manually using a hand-held Engineering Systems Designs Model 600 or Model 630 oxygen meter and a sampling probe. The sampling probe consisted of a hollow copper tube with a series of holes drilled in one end, and a manifold attached to the opposite end. The oxygen sensor was placed within an air-tight fitting in the manifold, and a hand-operated air pump was used to draw interstitial gasses from the compost through the probe and across the oxygen sensor. Oxygen was monitored at three locations within the static tanks representing the top, middle, and bottom. The oxygen meter was calibrated daily according to manufacturer's directions. Oxygen measurements were taken a minimum of two times per week and recorded in field logbooks. Occasional measurements of a 1% oxygen calibration gas were conducted to verify the accuracy of the instrument.

3.7.2 OXYGEN CONTROL

Oxygen control within the static tanks was also provided for by the blower control system. It has been shown that approximately five to seven times more airflow is required to remove heat than to provide oxygen [2]. Consequently, sufficient oxygen would normally be provided in the course of controlling the temperatures. In order to provide oxygen during periods when blowers were not activated by temperature (during the initial warm-up phase and during periods when temperatures were remaining steady within the desired range), the blowers were controlled by a backup timer cycle, which ensured periodic bursts of air for oxygenation. The adequacy of this approach would be verified by oxygen monitoring (Subsection 3.7.1).

3.8 MOISTURE

3.8.1 MOISTURE MONITORING

The moisture content within the static tanks was monitored at least once per week. For each sampling event, a top, middle, and bottom sample was taken at a random location within the tank. For each of these three samples, three replicate analyses were conducted. The moisture analyses were conducted in the on-site laboratory using the following procedure:

- For each sample, weigh and label three 50-mm diameter aluminum drying pans. Record these tare weights.
- Place 7 to 10 grams of compost sample into each of the three replicate aluminum pans and weigh each pan. Record these weights.
- Using a rinse bottle, carefully wet the samples with distilled water to their saturation point.
- Remove any excess water from the pan by absorbing it with a paper towel. Be careful not to remove any solids with the free water. Weigh these saturated samples and record the weights.
- Dry the samples overnight in an oven at 103 °C.
- Weigh the dry samples and record the weights.

As these measurements were taken, the values were manually entered into a spreadsheet on the data management system at the office trailer. The calculations were performed automatically, and the resulting values were displayed. The four values provided by the spreadsheet were:

- Percent moisture (wet basis).
- Water-holding capacity (i.e., percent moisture at saturation).
- Percent saturation.
- Percent water-holding capacity.

The equations for calculating each of the above values are given in Appendix B. In general, percent water-holding capacity (%WHC) was used to determine the need for moisture additions to the static tanks, with the goal being to maintain the tanks between 50 and 60% WHC.

3.8.2 MOISTURE CONTROL

When moisture content of the compost within the static tanks was found to be below the desired range of 50 to 60% WHC, additions would be made using a watering probe. The probe consisted of a 5-ft-long copper tube with a series of holes drilled in the end

to provide even distribution of water. The flowrate of this watering apparatus was determined to be 10 gallons per minute (gpm). Based on this flowrate, 10 to 20 gallons of water were usually added to each tank as necessary. Because there was no way to remove moisture once it was added, care was taken to ensure the piles were not overwatered. Based on their experience, field personnel were able to determine moisture addition requirements by visual inspection of the compost consistency.

3.9 pH

3.9.1 pH MONITORING

Twice per week, pH levels of the compost within the static tanks were monitored. For each sampling event, three compost samples were taken from each tank at the same sampling locations as used for moisture monitoring (see Subsection 3.8.1). The pH was determined for each sample by the following method:

- Place 10 g of compost and 50 mL of distilled water into a 100 mL beaker.
- Stir the resulting suspension every 10 minutes for 30 minutes.
- Allow the suspension to settle for 1 hour.
- Measure the pH of the supernatant with a digital pH meter.

3.9.2 pH CONTROL

As indicated in the test plan, pH control was considered in the amendment selection process. No attempt was made to adjust the pH of the compost at any point in the study.

3.10 EXPLOSIVES SAMPLING

3.10.1 SAMPLING AND ANALYSIS

To evaluate the extent of explosives transformation with time, periodic compost samples were taken from the static tanks and shipped to the WESTON Analytics Division laboratory in Lionville, Pennsylvania, for explosives (TNT, RDX, HMX, TNB, DNTs) analysis. These samples were taken on days 0, 10, 20, and 40 of each test series (A, B, C, and D). For each sampling event, five compost samples were taken from both the control and seed tanks along vertical planes within each tank. The precise orientation of the plane depended upon which day of the study was being sampled. These orientations, as well as the sampling locations within each plane, are shown in Figure 3-5.

To obtain samples from the static tanks, a pitchfork was used to expose the top and middle samples, which were subsequently taken by hand. To obtain bottom samples, the pitchfork was used to expose the sample, and then a soil auger was used to obtain the sample.

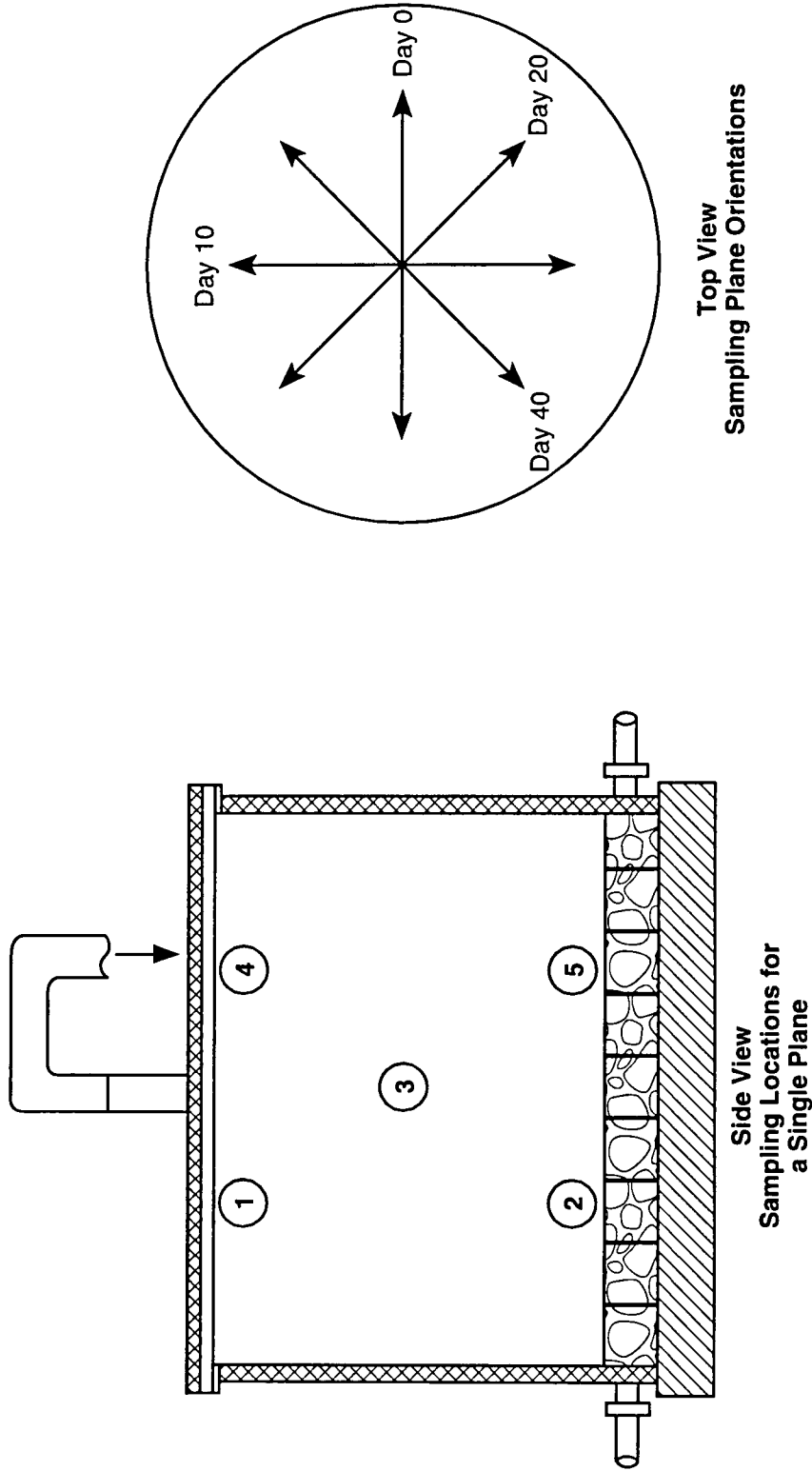

FIGURE 3-5 SEEDING STUDY EXPLOSIVES SAMPLING LOCATIONS

1306-793 2/1993

3.10.2 SAMPLE PREPARATION AND ANALYTICAL PROCEDURE

Samples taken from static tanks were placed on screens above aluminum drying pans. The samples were then allowed to dry for several days in the drying shed. Once dried, the samples were bottled and shipped to WESTON for analysis by overnight freight with chain-of-custody documentation.

Upon their arrival at the laboratory, the dried compost samples were milled in a Wiley mill to produce a homogeneous product. The sample preparation procedure, including air drying and milling, was developed for the previous UMDA demonstration project [1]. Prior to commencing use of the Wiley mill, a QA/QC procedure was conducted to ensure that proper equipment decontamination was occurring between samples. These results are presented in Appendix C. Following milling, the dried, homogenized samples were submitted for analysis by USATHAMA Method LW02 which was modified for the extraction and analysis of compost. Details of this method are presented in Appendix D.

3.11 MICROBIOLOGICAL AND BIOCHEMICAL TESTING

Samples of compost from each of the aerated static tank tests conducted as part of the seeding study were submitted for microbiological and biochemical analyses to assess the performance of the aerated static tanks and evaluate the effects of the recycle seeding operation. Bacterial plate counts were conducted to quantify the number of aerobic, anaerobic, obligate anaerobic, and thermophilic organisms present in each compost sample.

3.12 SAFETY

Safety procedures followed for the seeding study are listed in the site-specific UMDA safety plan prepared specifically for this demonstration. The excavation of the contaminated soil and the initial mixing of the compost was conducted in Level C personal protective equipment which included disposable Tyvec coveralls, rubber boots, nitrile gloves, and a full face respirator fitted with GMC-H cartridges. Once the compost was mixed and placed in the tanks, dust was no longer a factor, and operations such as oxygen, pH, and moisture monitoring could then be conducted in a Modified Level D personal protective equipment, which included all the Level C equipment except the full face respirator.

3.13 U.S. ARMY BIOMEDICAL RESEARCH AND DEVELOPMENT LABORATORY (USABRDL)

Following the completion of the windrowing and seeding composting studies, one additional 40-day aerated static pile study was conducted in which a sample of contaminated compost labeled with carbon-14 was incubated within the tank. This labeled sample was then removed at the end of the study and shipped to USABRDL where a series of fate-and-effect studies were conducted. The results of these studies will be presented in a separate USAEC report.

3.14 SCHEDULE

Figure 3-6 illustrates the schedule by which the seeding study was conducted. Each study was conducted for 40 days, with the seeding and initiation of subsequent tests occurring every 20 days. Figure 3-6 presents only seed tests A through D. It is understood, however, that a corresponding control test was also established for each study and operated during the same period.

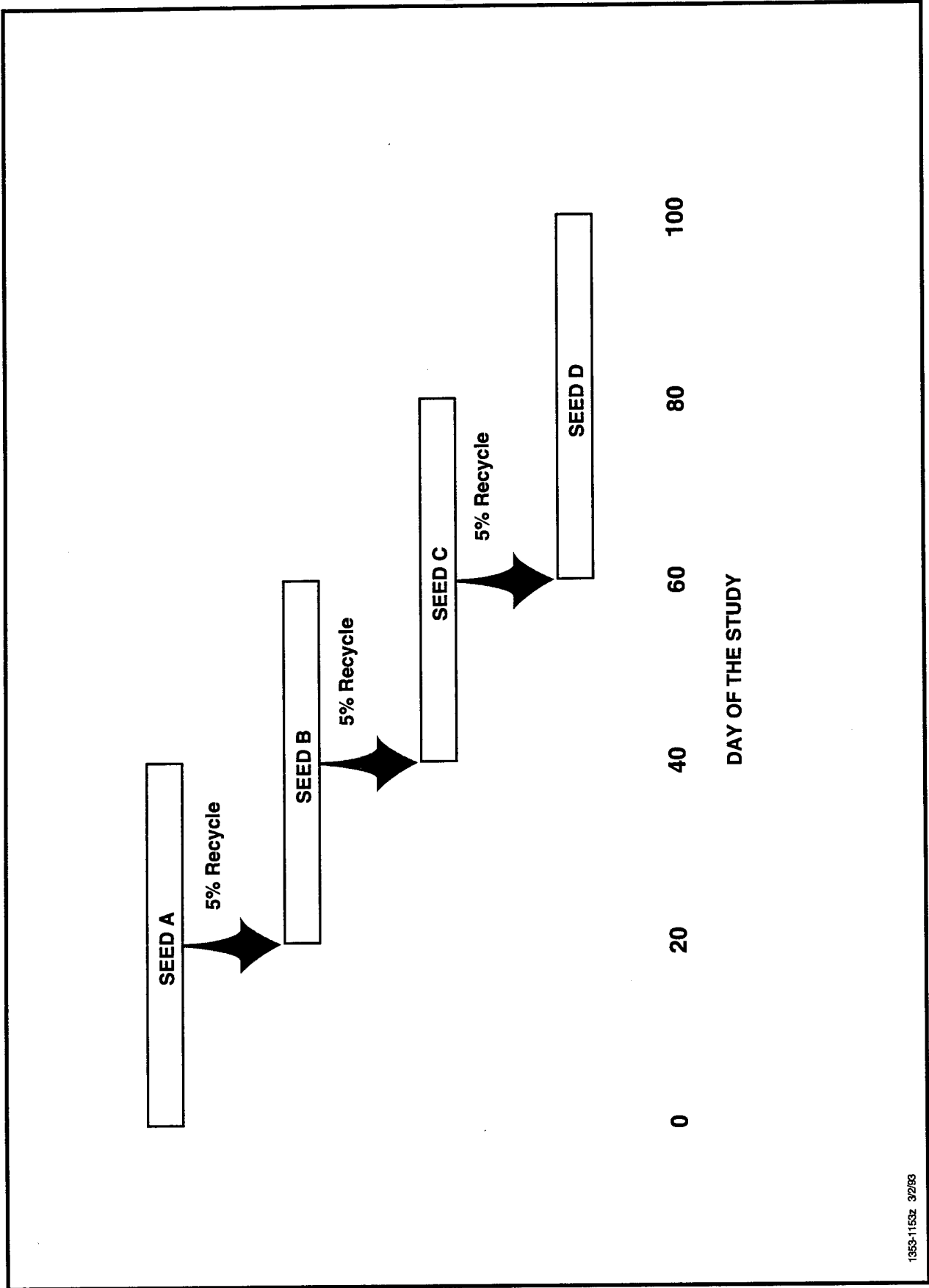

1953-1153z 3/2/93

FIGURE 3-6 SEEDING STUDY SCHEDULE

SECTION 4**MATERIALS AND METHODS FOR WINDROW STUDIES****4.1 SITE LAYOUT****4.1.1 UNCONTAMINATED WINDROWS**

Initial testing of the windrow approach was conducted to establish basic operating conditions for this technology. These tests used uncontaminated soils to avoid hazardous waste operating restrictions. Accordingly, these tests were conducted directly on a prepared soil/gravel base.

The site selected for the uncontaminated windrow studies was a gravel pit located approximately one-quarter mile northeast of the explosives washout lagoons. Figure 3-2 illustrates the location of the uncontaminated windrows with respect to the seeding study, washout lagoons, and the contaminated windrow site. Prior to construction of the windrows, the area was watered and rolled to provide a smooth, hard surface for the windrow operations. The area selected for operation of windrows 5 and 6 was chosen based upon its proximity to existing electrical power sources in the gravel pit. This electricity was necessary to operate the blowers and the instrumentation and control system associated with Windrow 5. This area was cleared with the front end loader and watered to create a smooth, hard surface on which to build and operate the windrows.

4.1.2 CONTAMINATED WINDROWS

In developing a strategy for conducting the contaminated windrow studies, it was understood that proper containment would be necessary to prevent the dispersal of the contaminants at the test site, and that this containment would need to fulfill state and federal requirements. Based upon the evaluation of "applicable or relevant and appropriate requirements (ARARs) presented in the Feasibility Study for the washout lagoons soils [3], it was determined that the federal Resource Conservation and Recovery Act (RCRA) regulations addressing both the biological treatment of hazardous wastes and the treatment of hazardous wastes in piles, would not be directly applicable to the composting of these soils. Rather, these regulations were judged "To Be Considered" criteria [3]. Based upon the FS, EPA issued a Record of Decision (ROD) identifying composting as the treatment alternative selected for the remediation of the washout lagoons soils. The ROD specifies that the full-scale operation will include an asphalt pad and a containment structure for the composting of the explosives-contaminated soils. These requirements were incorporated into the pilot-scale contaminated windrow study.

The location selected for the contaminated windrow study was an undeveloped section of ground located several hundred yards east of the washout lagoons (see Figure 3-2). This location was designated by UMDA for compost pilot test operations. A site plan

was prepared for construction of the compost facility. Upon receiving approval from UMDA officials, the area was cleared of all brush and then graded to design specifications. Next, an asphalt pad was installed to serve as the base for the contaminated windrows. A 6-inch concrete curb was placed around the edge of the pad to contain any rinsewater or leachate that might be produced by the operation inside the containment structure. A secondary asphalt curb was constructed around the outer perimeter of the building to collect runoff which might escape the building during decontamination at the end of the test. Waters generated within the containment structure from decontamination of equipment and personnel were collected in a 6-ft.-diameter, 100-gallon (approximately) sump at the eastern edge of the asphalt pad. Rainwater runoff collected by the outer curb was drained off-site, however, in the event that this water should become contaminated, it also could be routed into the collection sump. Any accumulated water in the sump would be pumped to 55-gallon drums for transfer to the existing Remedial Investigation evaporation ponds located on UMDA. The layout of the contaminated windrow site is presented in Figure 4-1. A temporary containment structure covered the asphalt area.

4.2 CONTAINMENT BUILDING

A temporary structure was constructed over the asphalt pad to prevent wind, rain, and any other climatic factors from spreading contaminated compost or negatively affecting the operation of the windrows. The structure, which was leased from Clamshell Buildings, Inc., is tent-like in appearance and has large doors at both ends, which can be raised by the use of manually operated winches.

Lighting and power within the building were installed by a local electrical contractor after the structure had been constructed. Four lights were suspended from the ceiling of the building. The structure used in these tests were selected from among several comparable units based upon factors such as availability and cost. Other similar units considered are presented in Appendix A. Further manufacturer's specifications for the structure are also presented in Appendix A. A cross-sectional side view of the building is shown in Figure 4-2.

4.3 WINDROW TURNER

Windrow composting tests were conducted using a conventional windrow turner, to both homogenize the compost during construction of the piles, and to provide periodic aeration and mixing throughout the course of the study. The windrow turner employed for these studies was a Model KW 614, manufactured by Resource Recovery Systems of Nebraska. This unit was selected from among a variety of similar commercially available compost windrow turners, based upon size, availability, and cost. A list of other available windrow turners is provided in Appendix A.

This self-propelled turner is 24 ft wide, 12 ft long, and 12.5 ft high. The mixing action produced by the machine is created by a horizontal, 16-inch diameter, rotating drum to which a series of fixed flails is attached. As the machine moves through the

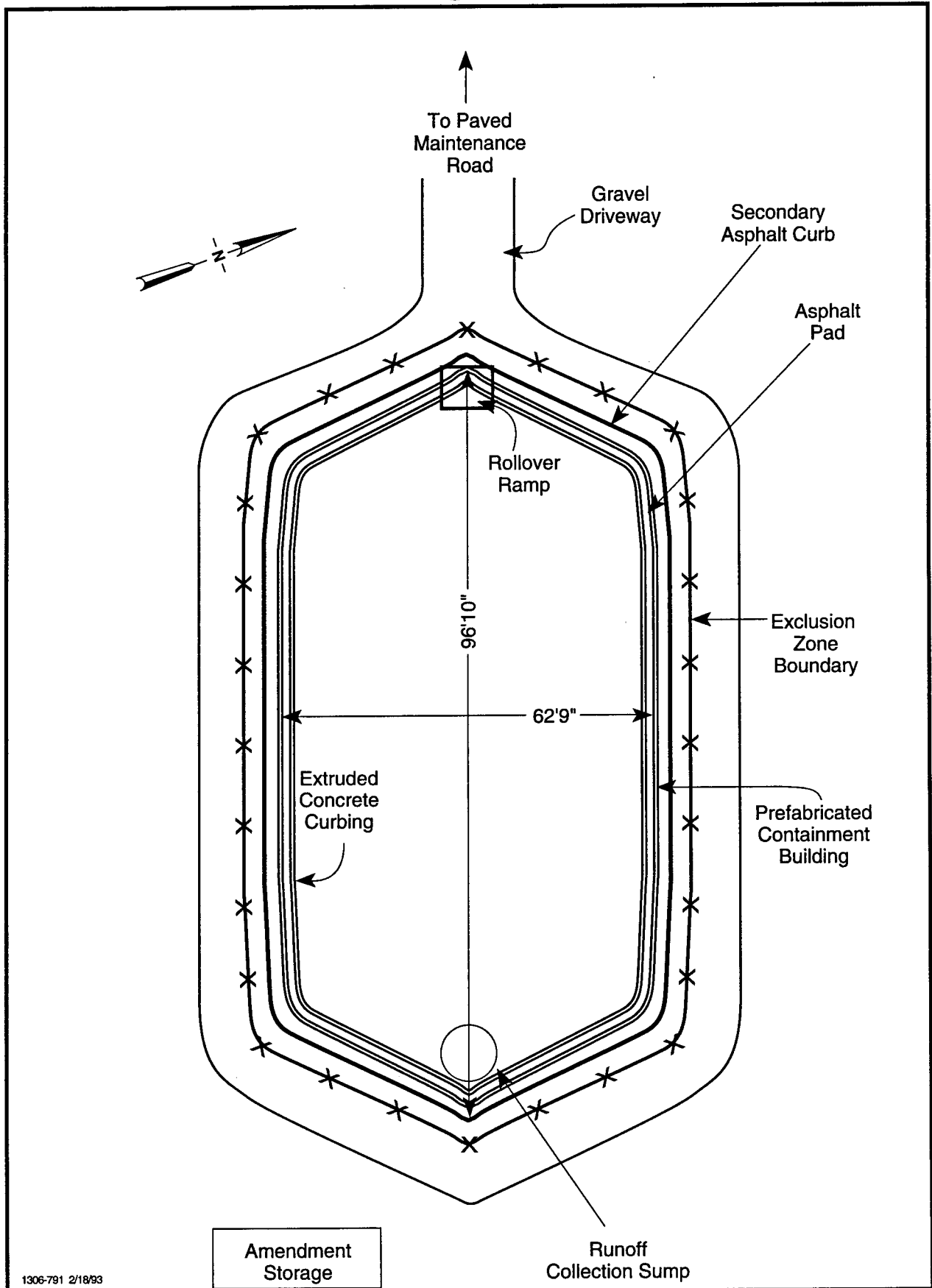
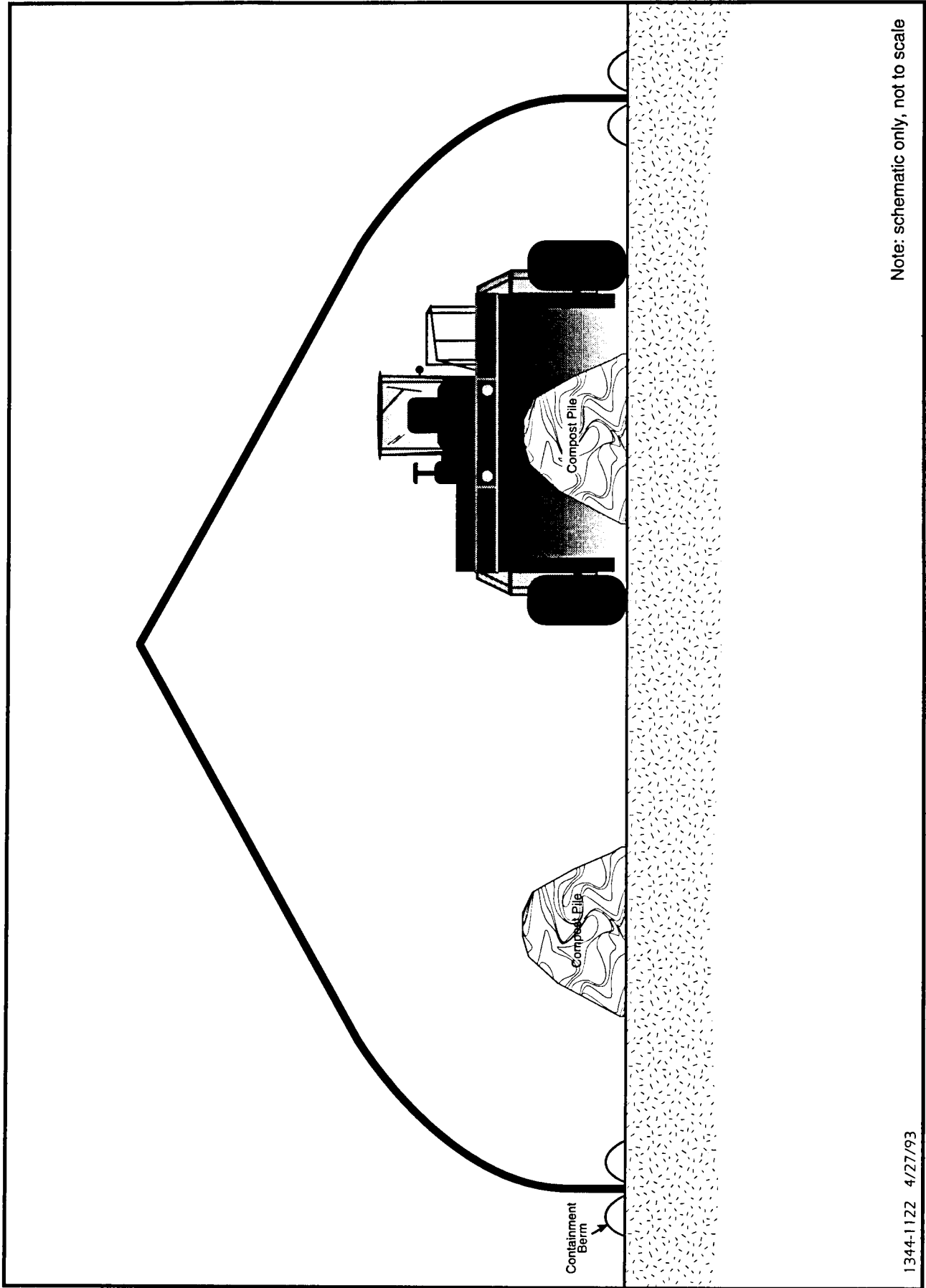

FIGURE 4-1 CONTAMINATED WINDROWS SITE LAYOUT



Note: schematic only, not to scale

1344-1122 4/27/93

FIGURE 4-2 CROSS-SECTIONAL SIDE VIEW OF CONTAMINATED WINDROW SITE

windrow, the compost is lifted, pulverized, mixed, and reformed into a windrow. Manufacturer's specifications for this turner are provided in Appendix A. The manufacturer provided on-site operator training for the machine.

A Hazard Safety Review was conducted for the selected windrow turner by Allegany Ballistics Laboratory. This evaluation indicated that, with proper precautions, this windrow turner could be used with explosives-contaminated soils. A copy of the Hazard Safety Review is presented in Appendix E. It should be noted that a similar review would be required for other compost machinery.

4.4 TEST SOIL

4.4.1 UNCONTAMINATED SOIL

The uncontaminated soil used in the construction of windrows 1 through 6 (referred to as UWR1 through UWR6) was excavated from a UMDA-approved site, which was located away from any sources of contamination. To confirm that the soil was free of unwanted contaminants, 5 random soil samples were taken from this area prior to excavation and analyzed for explosives. The results of these analyses are presented in Table 4-1.

Soil was excavated with a backhoe and loaded directly into a 12 yd³ dump truck. The soil was then transferred to the windrowing site at the gravel pit, where it was staged for future use in the compost mixture.

4.4.2 CONTAMINATED SOIL

The soil to be used in the contaminated windrow study was removed from the sidewalls of the washout lagoons with an excavator. As each bucket was excavated, it was placed onto a specially constructed screening box to separate the soils from the rocks and gravel that lined the lagoon. As the soils accumulated in the screening box, they were removed and transported to the soils storage box by the front-end loader. A total of approximately 18 yd³ of soil was excavated and screened to be used in the contaminated windrows.

The determination was made to conduct contaminated windrow testing at initial TNT concentrations of approximately 1,000 to 2,000 mg/kg. At the intended 30% soil volumetric fraction (based upon observations from uncontaminated windrow testing), the target soil TNT concentration for this phase of testing was therefore approximately 6,000 mg/kg. The soil was transported to the temporary structure for use in the windrows, and was then homogenized within the structure through the use of the backhoe. Results of the analysis of five random samples taken of this soil before incorporating it into the compost mixture are presented in Table 4-2.

Table 4-1

Uncontaminated Windrow Soils Data

Sample Number	2,4,6-TNT (µg/g)	RDX (µg/g)	HMX (µg/g)	1,3,5-TNB (µg/g)	2,6-DNT (µg/g)	2,4-DNT (µg/g)
001	2.04 U	1.04 U	1.35 U	2.22 U	0.42 U	0.45 U
002	2.02 U	1.03 U	1.33 U	2.19 U	0.42 U	0.44 U
003	2.02 U	1.03 U	1.34 U	2.2 U	0.42 U	0.44 U
004	2.01 U	1.03 U	1.33 U	2.19 U	0.42 U	0.44 U
005	2.01 U	1.03 U	1.33 U	2.19 U	0.42 U	0.44 U

U = Analyzed, Not Detected. Value presented is lower detection limit.

Table 4-2

Contaminated Windrows Soils Data

Sample Number	2,4,6-TNT ($\mu\text{g/g}$)	RDX ($\mu\text{g/g}$)	HMX ($\mu\text{g/g}$)	1,3,5-TNB ($\mu\text{g/g}$)	2,6-DNT ($\mu\text{g/g}$)	2,4-DNT ($\mu\text{g/g}$)
001	6,390	1,890	289	12.00 J	3.62 U	4.52
002	6,590	2,130	295	12.50 J	4.12 U	4.38
003	6,460	2,060	294	12.70 J	3.95 U	4.21
004	7,090	2,230	311	13.60 J	3.75 U	4.68
005	7,070	2,270	307	12.90 J	3.85 U	4.85
Averages	6,720	2,116	299	12.74	1.93	4.53

U = Analyzed, Not Detected. Value presented is lower detection limit.
 J = Present below detection limit.

Note: For calculation of average concentrations, J-Values and one-half of the lower detection limit presented for U-Values have been used.

4.5 AMENDMENTS AND RECIPE

Prior to the previous field optimization studies at UMDA, an in-depth study was conducted by WESTON and the Woods End Research Laboratory (WERL) to identify potential amendment sources in the vicinity of UMDA, and to develop a workable "compost recipe", taking into consideration such factors as pH, carbon to nitrogen (C:N) ratio, moisture content, homogeneity, seasonal availability, cost, total metabolic energy content, rate of carbon substrate use, texture, form, and porosity. Parameters such as moisture content, pH, C:N ratio, and nutrient content are important for maintaining proper conditions for microbial activity. Physical characteristics such as density, texture, and porosity are important for materials handling and maintenance of proper gas exchange within the compost.

Additional recipe formulation work was conducted for this study because of changes in the availability of amendment materials. Bench-scale testing was conducted to identify the best combination and proportions of available amendments. Once a recipe was selected, further studies were conducted to assess the effect of different soil loading rates on compost heating performance. The results of the tests showed excellent heating performance at all soil loading rates (0%, 10%, 20%, and 30% soil by volume). Although the studies indicated better heating performance with decreasing soil loading, the observed respiration rates per unit of carbon were similar among the samples tested. This indicates that within a range of soil loading of 0% to 30% soil by volume, degradation rates are likely to be consistent. Details of the selection criteria and compost recipe formulation process will be presented in a separate report. Based on this testing and on the results of the previous MAIV and ASP field studies, a recipe was developed for the windrow and seeding studies conducted at UMDA.

Adjustments were made to the recipe based on the soil loading rates required for each windrow such that proportions of individual amendments with respect to each other remained constant. Amendments used in the windrow studies included sawdust, wood chips, alfalfa, cow manure, chicken manure, and potato processing wastes. These amendments were obtained fresh and staged adjacent to the windrow sites prior to the preparation of each set of piles. The total volume of each windrow was intended to be approximately 30 yd³. The recipes used for each set of windrows are given in Table 4-3. The amendment recipe was modified slightly for uncontaminated windrows 3 and 4 (UWR3 and UWR4) in an attempt to increase the measurable interstitial oxygen in the pile. Wood chips were substituted for one-half of the sawdust called for in the original recipe in an attempt to increase the porosity and natural aeration in the piles.

To maintain consistency between studies, the amendment sources were held constant throughout the study. The names, addresses, and phone numbers of these amendment suppliers are provided in Appendix A. In addition, the putrescible amendments, such as the cow manure, chicken manure, and potato processing waste, were always obtained freshly within one or two days prior to the preparation of the compost, to ensure that the physical and chemical properties of these amendments were as similar as possible to those of the original samples on which the compost recipe was based. Slight variability in amendment characteristics may have existed between individual supplies.

Table 4-3
Windrow Studies Compost Recipes

	Sawdust		Alfalfa		Wood Chips		Hen Manure		Cow Manure		Potatoes		Soil		Totals	
	yd ³	%	yd ³	%	yd ³	%	yd ³	%	yd ³	%	yd ³	%	yd ³	%	yd ³	%
Windrows 1 & 2	7.2	22.9	7.2	22.9	0	0	1.4	4.5	8.5	27.1	4.0	12.7	3.1	9.9	31.4	100
Windrows 3 & 4	3.2	10.2	6.4	20.4	3.2	10.2	1.2	3.9	7.5	24.0	3.6	11.5	6.2	19.8	31.3	100
Windrows 5 & 6	5.5	17.7	5.5	17.7	0	0	1.0	3.3	6.6	21.3	3.1	10.0	9.3	30.0	31.0	100
Windrows 7 & 8	5.5	17.7	5.5	17.7	0	0	1.0	3.3	6.6	21.3	3.1	10.0	9.3	30.0	31.0	100

Table 4-4 presents initial physical and chemical characteristics, as measured, for samples taken from the initial compost mixture for the two contaminated windrows. Where applicable, the values predicted by the compost recipe have also been provided. The slight variability in values between samples may be attributed to the inherent variability of the compost matrix as well as the relatively limited degree of compost homogenization that is typically achieved on the first day of operation. Nonetheless, the averages presented showed favorable comparison to the recipe, and are representative of composts that demonstrated successful reduction of explosives.

4.6 CONSTRUCTION OF WINDROWS

The measurement and transport of amendments and soil during construction of the windrows was accomplished through the use of the front-end loader. The capacity of the loader's bucket was measured using known volumes of water and determined to be 0.5 yd³. In addition, 0.1 yd³ graduations were marked on the bucket with tape to further increase the accuracy of measurement. The loader was then used to transport known volumes of amendments and soil to the windrows.

The standard order of amendment additions and mixing intervals determined empirically through observations made during the construction of UWR1 and UWR2 was as follows:

- For aerated windrows, lay out perforated piping network and cover with wood chips to a depth of 6 inches.
- Stack bales of alfalfa in line along the intended axis of the windrow. For the aerated windrows, place alfalfa bales on top of the bed of wood chips.
- Cover alfalfa with the sawdust and/or woodchips.
- Mix windrow once with compost turner.
- Add cow manure, chicken manure, and potatoes.
- Mix windrow once with compost turner.
- Add soil.
- Mix windrow twice to homogenize compost mixture.

4.7 MIXING OF WINDROWS

4.7.1 UNCONTAMINATED WINDROWS

At each turning event, the windrow turner was passed once through each windrow. The turner was operated in accordance with manufacturer's guidelines.

Table 4-4

Physical and Chemical Properties of the Initial Compost Mixture for the Contaminated Windrow Tests

Parameter	CWR7 - Aerated				CWR8 - Un aerated				Recipe
	Top	Mid	Bot	Avg.	Top	Mid	Bot	Avg.	
Density (lb/ft ³ wet)	55	54	50	53	52	54	52	53	52
Solids (% wet basis)	71.3	63.8	68.8	68.0	66.0	70.1	66.6	67.6	70.3
Moisture (% wet basis)	28.7	36.2	31.2	32.0	34.0	29.9	33.4	32.4	29.7
pH	5.61	5.34	5.06	5.34	5.03	4.95	5.05	5.01	-
Organic Matter (% wet basis)	12.6	15.4	11.7	13.2	14.5	13.9	14.3	14.2	16.6
Carbon:Nitrogen Ratio (wgt:wgt)	26.1	-	19.7	22.9	27.5	25.8	-	26.6	31.3
Total Nitrogen (% wet basis)	0.261	0.269	0.321	0.284	0.284	0.292	0.282	0.286	0.276
Organic Nitrogen (% wet basis)	0.235	0.250	0.284	0.256	0.250	0.269	0.244	0.254	-
Ammonium-N (ppm wet basis)	248	170	341	253	334	235	362	310	-
Nitrate-N (ppm wet basis)	16	23	27	22	4	2	17	8	-
Nitrite-N (ppm wet basis)	<1	1	<1	<1	<1	<1	0	<1	-
Chloride (ppm wet basis)	181	181	263	208	286	240	290	272	-
Sulfate (ppm wet basis)	30	28	3	20	40	33	47	40	-

The Total Nitrogen Value presented under the "Recipe" column represents Total Kjeldahl Nitrogen, which does not include Nitrate-N and Nitrite-N.

As the windrow turner moves through the windrow, it reshapes the pile. By the nature of its operation, however, the turner has a tendency to displace the windrow from 6 to 8 ft in the direction opposite to the direction it is moving. Also, the turner leaves an unshapely trail of compost at both ends of the windrow.

For the first four uncontaminated windrows, these features of the turner did not present a problem. The ends of the windrows could be quickly reshaped using the front-end loader on the backhoe. Also, because these windrows were widely spaced, the displacement of the windrows did not present a problem. By alternating the direction of turning, the windrows were maintained in the same general location throughout the test.

The windrow turner was passed over the aeration system of aerated windrows using the adjustable height control on the machine. For the aerated windrow (UWR5), additional effort was necessary to maintain the windrows in place above the aeration system. Using the front end loader, the 6 to 8 ft of windrow displaced by the passing of the turner was replaced on top of the wood chip bed at the forward end of the windrow. In this way, a cycling effect was established within the windrow as compost displaced each day was replaced from one end of the windrow to the other. It is reasonable to assume that this cycling effect also increased homogeneity in the windrow, since this mixing and displacement prevented compost from remaining in one location throughout the study.

4.7.2 CONTAMINATED WINDROWS

Mixing of the contaminated windrows was complicated by the limited space and ventilation within the containment structure. Because the two windrows were always turned from the same direction, the cycling procedure explained above for UWR5 was used for both the aerated (CWR7) and the unaerated (CWR8) windrows with the exception that a skid loader was used inside the building rather than the front-end loader to reform the pile. In general, the unaerated windrow (CWR8) was turned first with the western door open to provide ventilation. Afterwards, the visibility was usually limited by the water vapor released during the mixing, and time was allowed for the vapor to dissipate. During this waiting period, which typically ranged from 5 to 10 minutes, both doors of the structure were raised and ventilation was further facilitated through the use of two industrial floor fans.

When visibility was restored, the western door was closed in preparation for the turning of CWR7, to prevent any contaminated materials from being thrown outside by the windrow turner. The eastern door was left open to provide ventilation during turning. The piping was disconnected from the aeration system at the windrow to allow the turner to pass, and the turner was carefully positioned 6 inches off the ground to ensure safe clearance of the piping, 6-inch x 6-inch timbers, and the wood chip bed. Following turning, the western door would again be raised to provide ventilation.

Operating experience showed that the windrow turner would tend to throw small rocks and stones from the compost during the turning operation, raising concern over both the dispersal of compost materials and potential projectile hazards. In all testing, operating personnel maintained distance from the machine to avoid projectile hazards. During contaminated windrow turning, the doors of the structure were closed to prevent dispersal of the materials from the containment area.

4.8 TEMPERATURE

4.8.1 TEMPERATURE MONITORING

Temperature was treated as the primary indicator of successful achievement of conventional thermophilic composting operations in the windrows. The goal was to maintain average windrow temperatures near 55 °C [8]. Based upon conventional composting practice, such temperatures were interpreted to indicate a healthy, metabolically active windrow. Temperature decrease over time to below 50 °C was viewed as an indicator of a pile that was nearing the end of its operation.

To determine the cooling effects associated with turning the windrows, temperature measurements were taken both before and after all turning events. For those windrows that were turned three times per week (windrows UWR1 and UWR3), only one set of temperature measurements were taken on the days on which no turning was performed.

To ensure that a representative profile of the windrow temperatures was obtained, measurements were taken along two separate planes within the pile, with nine sampling points per plane. One plane was oriented vertically along the central axis of the windrow, while the second plane was oriented parallel to the outside face of the windrow, approximately 1 ft below the surface. To maintain consistency of the data, these measurements were always taken from the same side of the windrow. Figure 4-3 presents an illustration of the orientation of the two sampling planes, and Figure 4-4 shows the sampling points in each of the planes.

The equipment used to obtain these temperature measurements included six K-type thermocouple landfill probes and a hand-held temperature meter with a digital display, which converts the thermocouple signal to a readout in degrees Celsius (°C). Each of the six thermocouple probes was inserted into one of the 18 sampling locations within a given windrow. As readings were taken, the thermocouples were moved to the next sampling location and allowed to equilibrate (1 to 2 minutes). During this adjustment time, the hand-held meter was used to take measurements from other thermocouples that had already been allowed time to adjust to their new locations. Cycling through probes in this manner ensured that stable temperature measurements were obtained without excessive delay in waiting for the probes to adjust to each new location. Calibration of the probes was conducted prior to the study to ensure accurate measurements. The results of this study are presented in Appendix C.

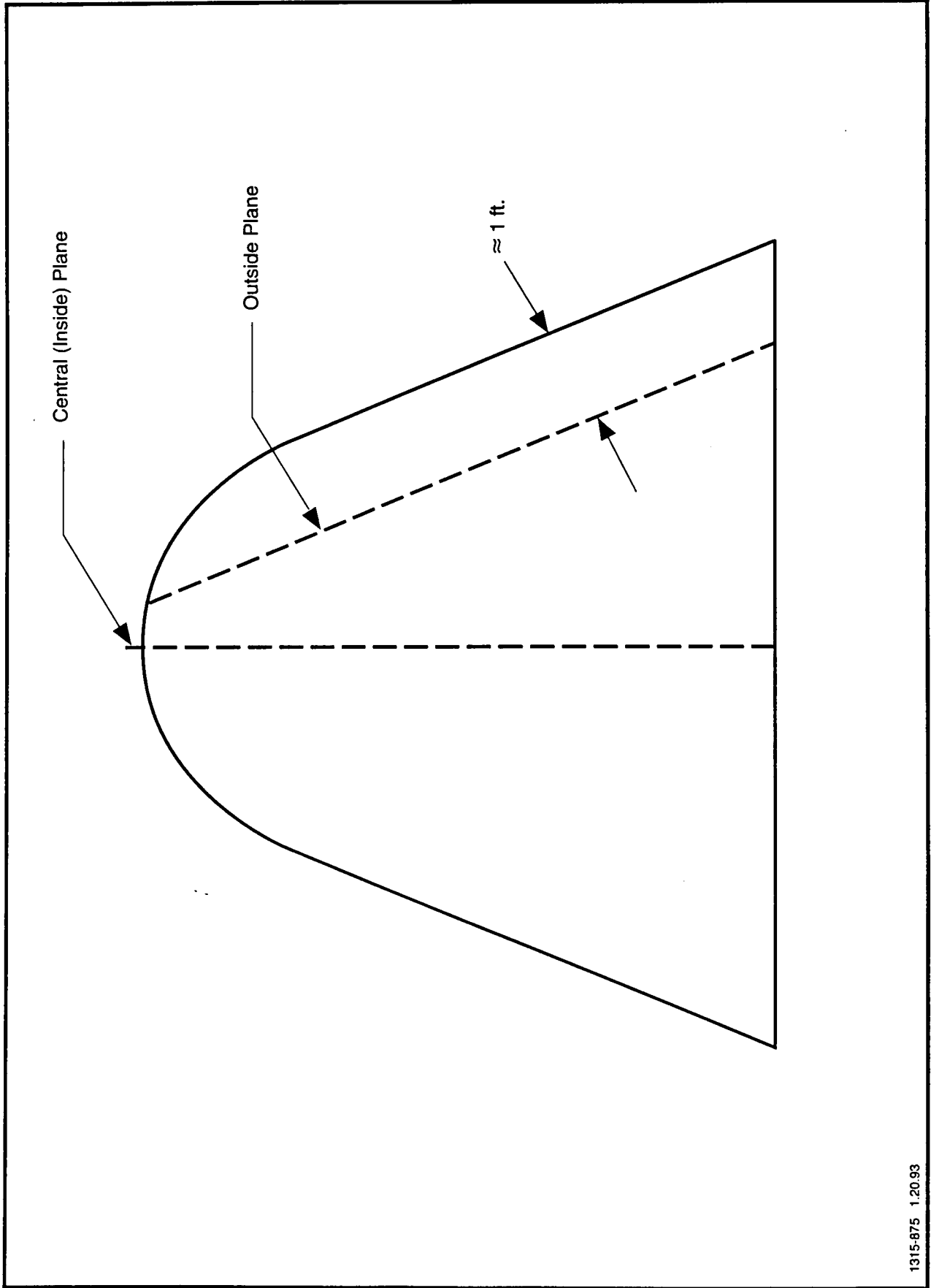
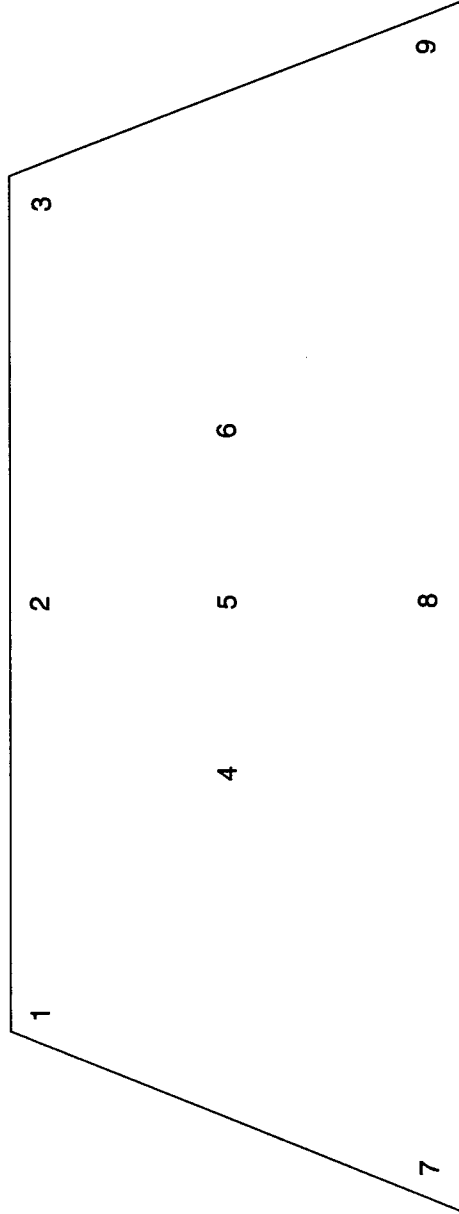

FIGURE 4-3 CROSS-SECTIONAL VIEW OF WINDROW

1315-875 1.20.93



SIDE VIEW OF WINDROW

1311-858 1/19/93

FIGURE 4-4 WINDROW MONITORING LOCATIONS

4.8.2 TEMPERATURE CONTROL

4.8.2.1 Unaerated Windrows

For the first four windrows (UWR1 through UWR4), no effort was made to control temperatures within the piles other than the stated mixing frequency. One of the goals of these tests was to evaluate whether mixing with the windrow turner alone would provide adequate temperature control. Although temperatures were often reduced as a result of the mixing process, the mixing schedule was not altered in an attempt to control temperatures in the pile. During operation of Windrow 6, as compost temperatures dropped near the end of the operation, mixing was reduced in an attempt to maintain temperatures through the end of the 40-day test period.

4.8.2.2 Aerated Windrows

Uncontaminated Windrow 5 (UWR5) and contaminated Windrow 7 (CWR7) employed an aeration system in an attempt to maintain oxygen levels within the windrows. While oxygenation was the main focus of this effort, the aeration system was also used to control temperatures. The windrow aeration systems were constructed by placing a series of 4-inch perforated corrugated pipes in a bed of woodchips under each windrow and connecting the ends of the pipes to blowers. The configuration of the piping system was slightly different in UWR5 than it was in CWR7, as illustrated in Figures 4-5 and 4-6. In addition, the number of blowers was increased from two in UWR5 to four in CWR7 after it was determined that two blowers were unable to control the temperatures in UWR5. Additional information on the aeration system and changes which were made based upon operating experience is provided in Subsections 5.2.3 and 5.2.4).

The aeration systems were controlled by temperature feedback instrumentation. The control strategy was analogous to that used for the aerated static pile reactors. Four J-type thermocouples were wired in parallel to provide a signal representing the average temperature of the four thermocouples. The value of the signal was compared with a set point and if it exceeded 60 °C, the blowers were automatically turned on to cool the pile to 55 °C. When not operating in this cooling condition, the blowers were controlled by a timer which periodically turned on the blowers to ensure the compost was well oxygenated.

4.9 OXYGEN

4.9.1 OXYGEN MONITORING

Interstitial oxygen levels within the windrows were monitored daily using the oxygen probe described in Subsection 3.7.1. The locations at which the oxygen readings were taken were consistent throughout the studies to provide consistency of the data. As with the temperature measurements, oxygen was monitored along the central inside plane and along the outside surface at the locations corresponding to temperature

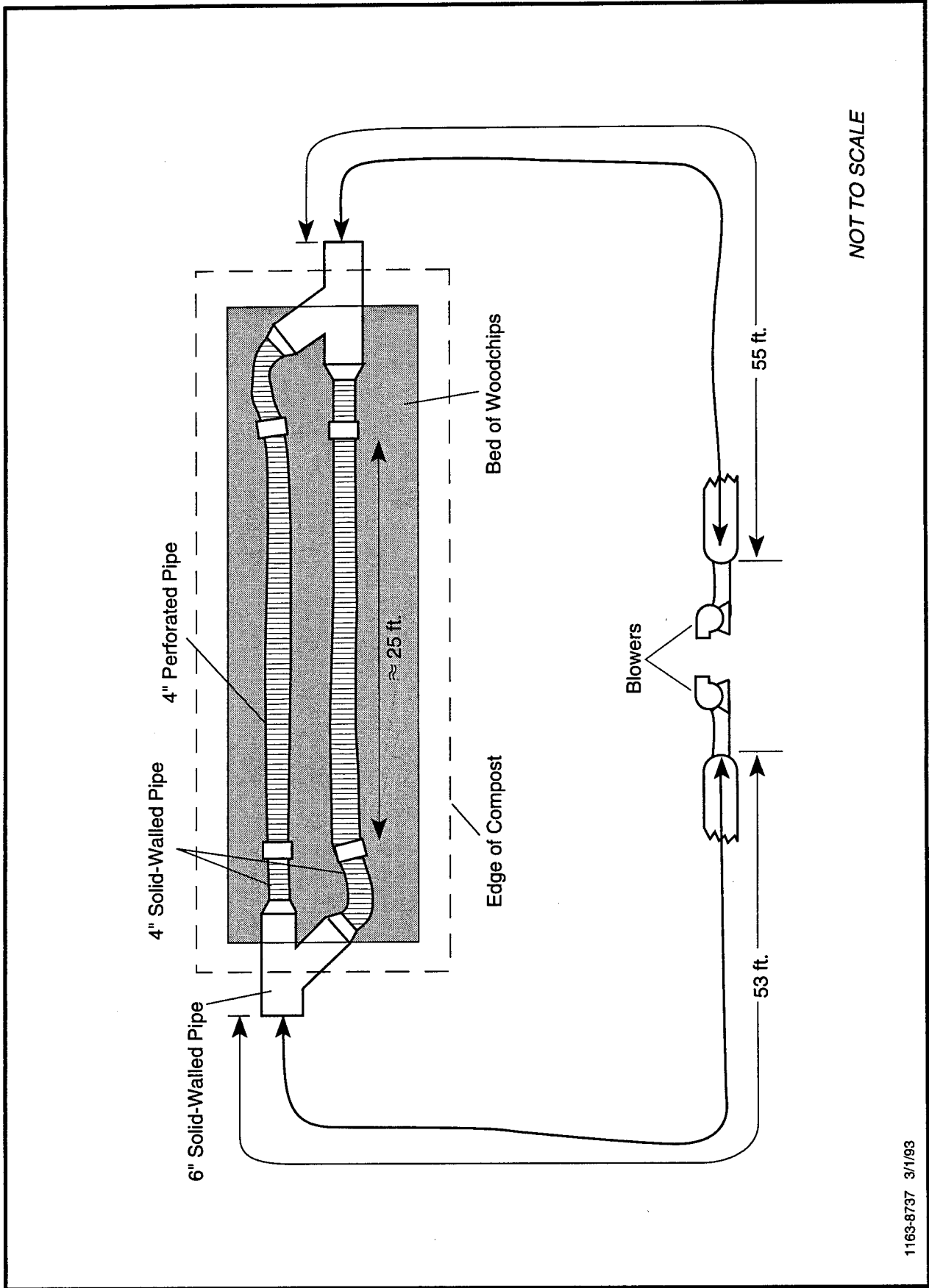
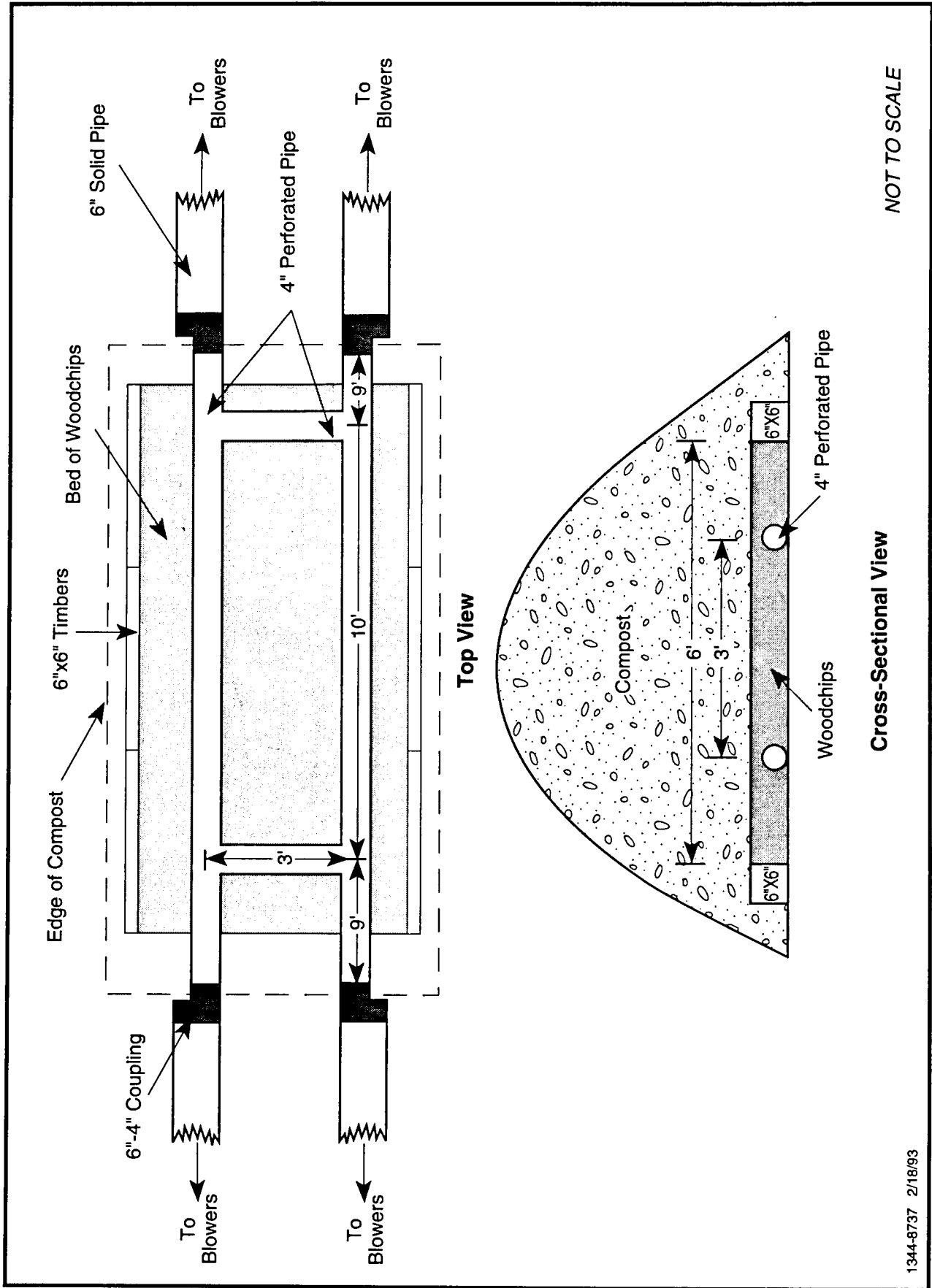

FIGURE 4-5 AERATION SYSTEM DIAGRAM FOR UNCONTAMINATED WINDROW No. 5 (UWR5)



1344-8737 2/18/93

FIGURE 4-6 AERATION SYSTEM DIAGRAM FOR CONTAMINATED WINDROW No. 7 (CWR7)

sampling locations 1, 5, and 9. This provided top, middle, and bottom readings and enabled a comparison between the inner plane and the outer plane of the pile.

Oxygen sampling was conducted prior to and immediately after turning the windrows to assess the aerating properties of the windrow turner.

4.9.2 OXYGEN CONTROL

4.9.2.1 Unaerated Windrows

For windrows 1 through 4, 6, and 8, no effort was made to maintain oxygen levels within the compost. One of the goals of these tests was to determine whether the turning operation would provide sufficient aeration. Although the periodic mixing of the compost with the windrow turner did provide some oxygenation (discussed in Subsection 5.2), the mixing schedule was not altered for the sole purpose of oxygenating the windrows.

4.9.2.2 Aerated Windrows

For UWR5 and UWR7, the aeration system was directly employed to control the levels of interstitial oxygen within the piles. As explained in Subsection 4.7, temperature was used as the controlling variable in turning the blowers on to cool the piles. In the process of cooling the piles, however, the windrows were oxygenated by the blowers. During periods when the blowers were not operating on demand to cool the piles, the blowers were controlled by a timer which provided periodic bursts of air for oxygenation. The timing of these intermittent cycles was adjusted as necessary to maintain oxygen levels. Cycle times were typically on the order of 15 minutes Off Time and 20 seconds On Time. Adjustments were also made if it was determined that the pile was being overcooled. This was done by reducing the duration of the aeration period.

4.10 MOISTURE

4.10.1 MOISTURE MONITORING

Moisture samples from each of the six uncontaminated windrows were taken twice per week. Three samples were taken from each pile at the locations corresponding to internal-plane temperature monitoring locations 1, 5, and 9. The procedure for determining moisture levels is described in Subsection 3.8.1.

4.10.2 MOISTURE CONTROL

Water additions were made to the windrows as necessary based upon visual inspection of the piles, and upon moisture monitoring data. Such additions were conducted manually from the UMDA base water supply, using a standard garden hose whose flowrate had been determined to be 8 gallons per minute. These additions were made evenly over the pile just prior to turning such that following turning, the moisture

content would be relatively consistent. Moisture content was maintained within a range of 50 to 60% Water Holding Capacity (% WHC).

4.11 pH

4.11.1 pH MONITORING

Each week, pH levels within the windrows were monitored by three sampling events. For each sampling event, three compost samples were taken from each windrow at the same sampling locations as used for moisture monitoring (see Subsection 5.10). The procedure for measuring pH of windrow compost samples was the same procedure used for seeding studies as described in Subsection 3.10.1.

4.11.2 pH CONTROL

Because pH control was incorporated into the amendment selection process, no attempt was made to adjust the pH of the compost at any point in the study. Previous data [1] indicated that the pH of the compost may rise during the composting phase. While negative effects on explosives removal have not been noted in these cases, it is possible that control of pH may warrant consideration for full-scale operation. Volatilization of ammonia increases with increasing pH and may become problematic in a full-scale operation. As a result, controlling pH may indirectly reduce ammonia emissions. If necessary, minor reductions in pH can be achieved through the addition of gypsum (calcium sulfate) to the compost.

4.12 WINDROW SUPPLEMENTATION

For uncontaminated Windrow 4 (UWR4), and both the contaminated windrows (CWR7 and CWR8), an effort was made to extend the life of the pile by adding additional amendments after the piles had reached the end of their active life. In both cases, a fresh portion (5 yd³) of amendment mixture representing a small fraction of the original compost volume was mixed into the windrow. Results of these operations are presented in Subsections 5.2.2 and 5.2.4).

4.13 SAMPLING

4.13.1 UNCONTAMINATED WINDROWS

Routine sampling of the uncontaminated windrows consisted of periodic moisture and pH samples. In addition, various samples of the uncontaminated windrows were used in the biochemical and microbiological testing, and in the supplemental testing conducted at Oak Ridge National Laboratory (see Subsection 4.14 below).

4.13.2 CONTAMINATED WINDROWS

The contaminated windrows were periodically sampled for explosives and intermediates. These samples were taken on days 0, 5, 10, 15, 20, and 40 of the study as well as at the

beginning and end of supplementation. For each sampling event, 14 samples were taken and dried on screened drying pans in the drying shed. These samples were taken along the central plane at the nine locations indicated in Figure 4-4. In addition 5 other samples were taken from the pile: 2 from the central plane near the bottom and 3 from the outside plane near the bottom of the windrow. These samples were then sent to the analytical laboratory where they were milled and analyzed similar to the seed study samples described in Subsection 3.10.2. Samples of the contaminated windrows were also used in the supplemental testing (described in Subsection 4.14, below).

4.14 BIOCHEMICAL AND MICROBIOLOGICAL TESTING

Samples of compost from both the contaminated and uncontaminated windrows were submitted for microbiological and biochemical analyses to assess the performance of the different windrows. Bacterial plate counts were conducted to quantify the number of aerobic, anaerobic, obligate anaerobic, and thermophilic organisms present in each compost sample.

4.15 SUPPLEMENTAL TESTING OAK RIDGE NATIONAL LABORATORY (ORNL)

Composite samples of compost from both the contaminated and uncontaminated windrows were periodically shipped to Oak Ridge National Laboratory in Oak Ridge, Tennessee, where additional studies were conducted to assess the toxicity and mobility characteristics of the windrow compost at each interval in the study. The composite samples sent to ORNL were prepared from the dried and milled samples received from UMDA for each contaminated windrow for each sampling interval. In addition, several samples of compost were taken from the uncontaminated windrows (UWR5 and UWR6) approximately two weeks after the conclusion of the test on Day 40. These uncontaminated samples served as controls for comparison with the contaminated windrow results. The details of the studies conducted by ORNL will be presented in a separate USAEC report.

4.15.1 Clean Closure Leaching Test

The Clean Closure Leaching Test (CCLT), also referred to as the Synthetic Precipitation Leaching Procedure (SPLP) is a draft method (USEPA Method 1312) intended to "determine the mobility of both inorganic and organic analytes present in soils, wastes, and wastewaters" [see Appendix D for description of Method 1312]. The procedure simulates the leaching and mobilization of target compounds by natural precipitation. As a result, the method provides for two different extractions, depending upon whether the sample was obtained from a location east or west of the Mississippi River. These two different extractions are necessary to account for the differences in average pH of typical precipitation in these regions of the country.

ORNL performed this CCLT test for all composite samples submitted by WESTON, to determine the mobility of explosives and intermediates in the contaminated windrow

studies. In addition, WESTON Analytics conducted a similar test on one composite sample submitted for each of the contaminated windrows on Day 53 of the study. Each of these composite samples was prepared by taking a 100-mL sample from each of the 14 explosives sampling locations in each pile. For each pile, the 14 samples were mixed together and homogenized to form one composite sample.

These results are presented in Subsection 5.3.1.1.

4.15.2 Toxicity Studies

The toxicity studies conducted at ORNL included both an aquatic toxicology study and mutagenicity study. The aquatic toxicity studies were conducted on the CCLT extracts described above using the freshwater crustacean Ceriodaphnia dubia as the test organism. A separate extraction procedure was used to obtain samples for use in the Ames mutagenicity tests, which evaluated mutagenicity through the use of the (TA-98) and (TA-100) strains of Salmonella typhimurium [9]. For this test, a solvent exchange procedure was implemented in which the explosives were first extracted using acetonitrile. The acetonitrile was subsequently evaporated, and the explosives were then redissolved in dimethyl sulfoxide (DMSO) for use in the tests. More details on the procedure will be presented in a separate report.

4.16 SAFETY

Specific safety procedures followed for the windrow studies are presented in the site-specific safety plan developed for this demonstration. The uncontaminated windrows were constructed and maintained wearing Level D personal protective equipment. Excavation of the contaminated soil and construction of the contaminated windrows was conducted in Level C, using GMC-H cartridges in the full-face respirators. Later in the operation of the contaminated windrows, these cartridges were replaced with GMD-H cartridges because of the elevated levels of ammonia produced within the containment building.

SECTION 5**RESULTS****5.1 RESULTS OF SEED STUDIES**

The primary criterion of the effect of recycle on performance in these studies would be improvement in the rate and/or extent of explosives removal. Compost parameters, such as temperature, moisture, pH, and oxygen, were used to assess the adequacy of the compost operation.

5.1.1 TEMPERATURE

Temperature control within the static tanks was provided by the temperature feedback and blower control system installed for the previous field studies. The intended operation of the system was to maintain the temperature of the compost near 55 °C throughout the 40-day duration of each test. The control system was susceptible to occasional electronic and mechanical malfunctions, which caused periodic overcooling or overheating of the reactors. Ongoing efforts were made to minimize such problems and optimize operation of the system; however, temperature profiles in early trials were affected by these problems.

The daily average temperature profiles for each of the seeding tests, along with the daily average greenhouse and outdoor ambient temperatures, are presented in Figures 5-1 through 5-4. Compost temperatures represent the daily averages calculated from the five thermocouples in each reactor. These data show that effective thermophilic composting conditions were achieved in all reactors. Control system problems most seriously affected control reactor B, as well as control and seed reactors C. In the absence of control system malfunctions, thermophilic conditions were generally well maintained throughout the bulk of the 40-day test period.

In terms of the potential beneficial effect of compost recycle, the anticipated effect on temperature profiles would consist of more rapid or complete heating of the compost mixture. Because the maximum temperature range was controlled in these tests, these values cannot be directly used to assess recycle. Comparisons among the heating profiles for the four test Series (particularly series A and D where control problems were minimal) may suggest some slight decrease in the heating time in Series D, although the differences in starting temperature may be the dominant factor. Perhaps more significantly, temperature profiles between seed and control reactors in each series are similar. Based upon these observations, clearly discernible effects of recycling on compost heating are not apparent.

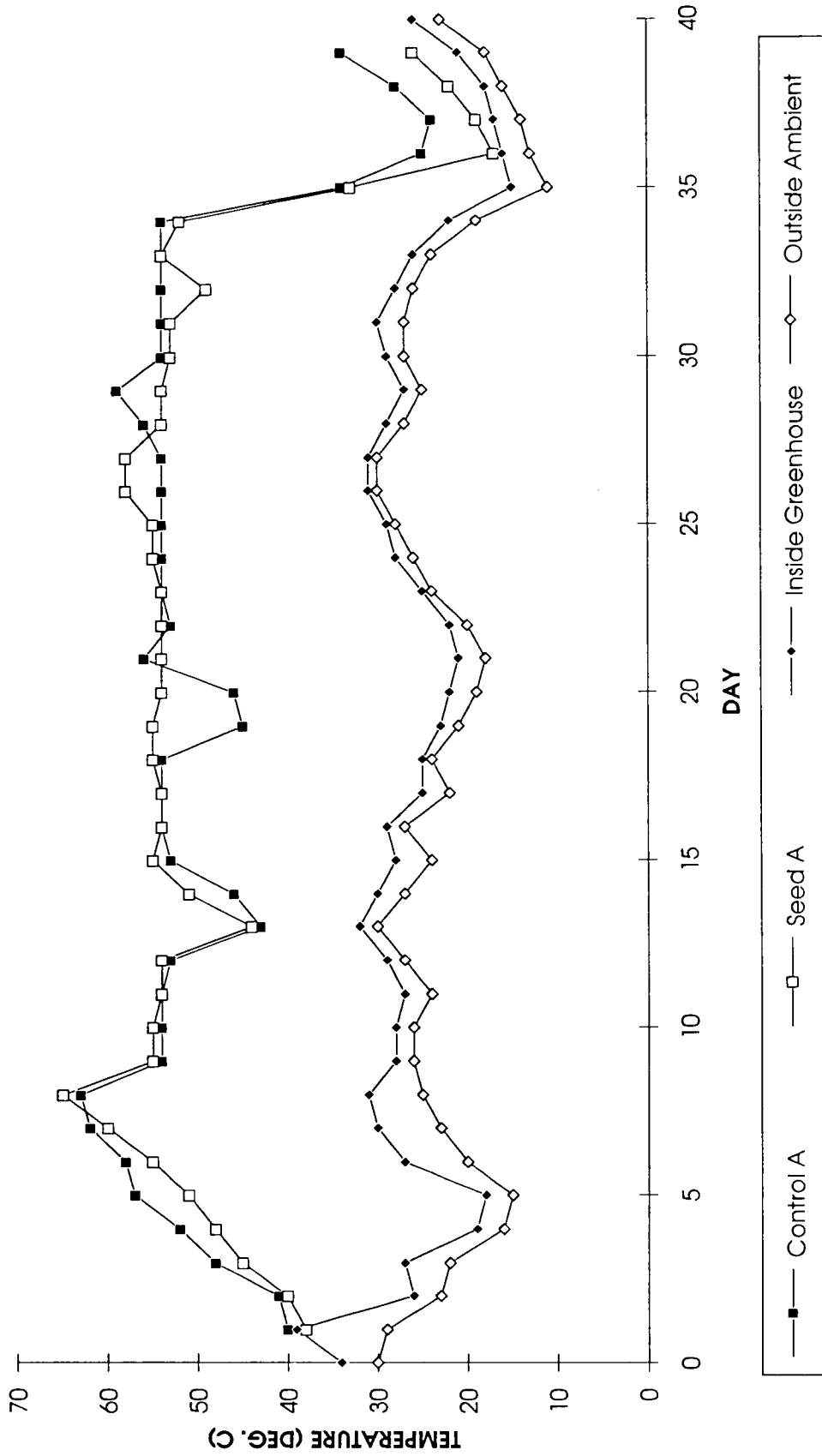

FIGURE 5-1 COMPOST AND AMBIENT TEMPERATURES FOR SEEDING STUDY A

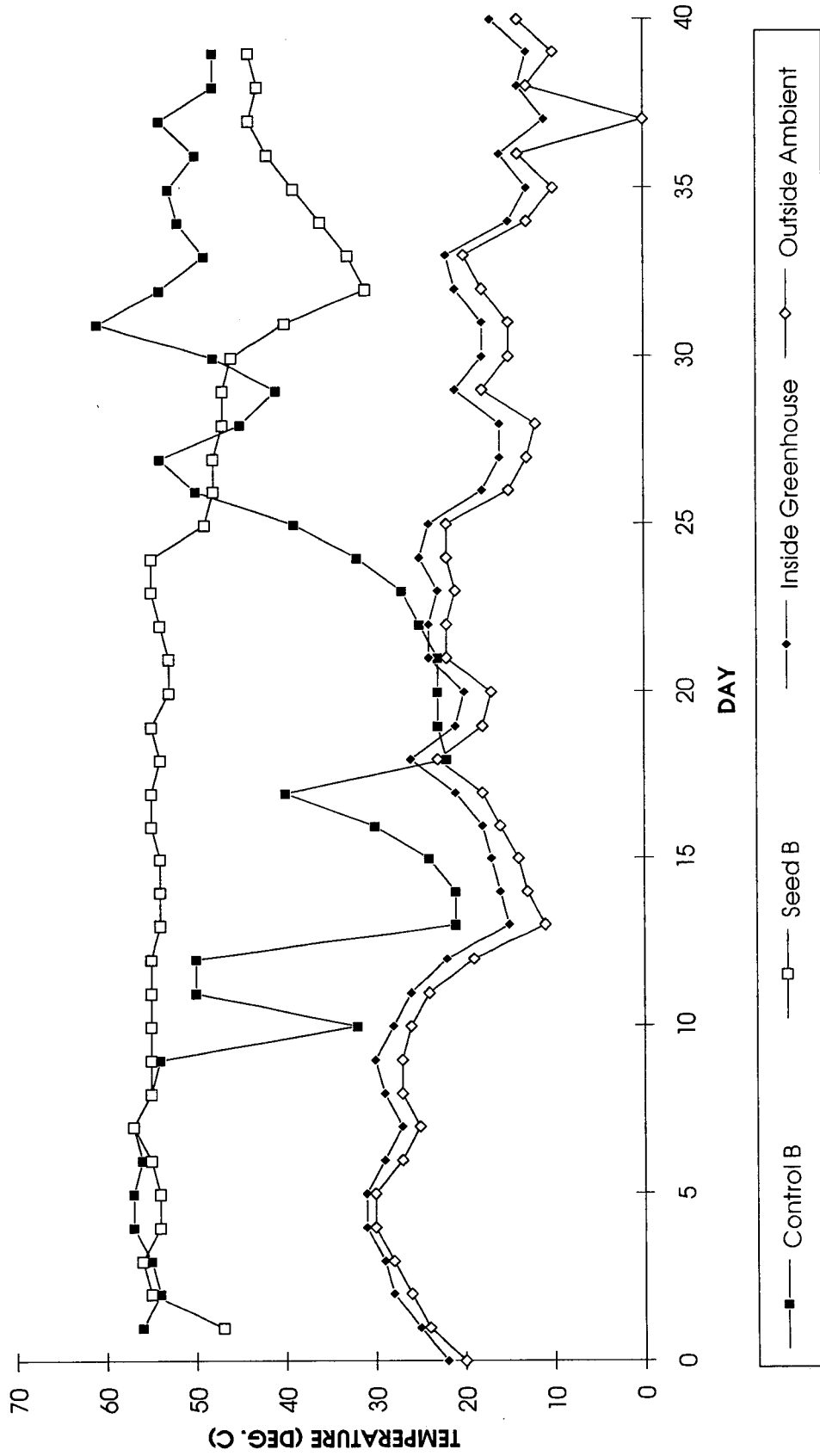

FIGURE 5-2 COMPOST AND AMBIENT TEMPERATURES FOR SEEDING STUDY B

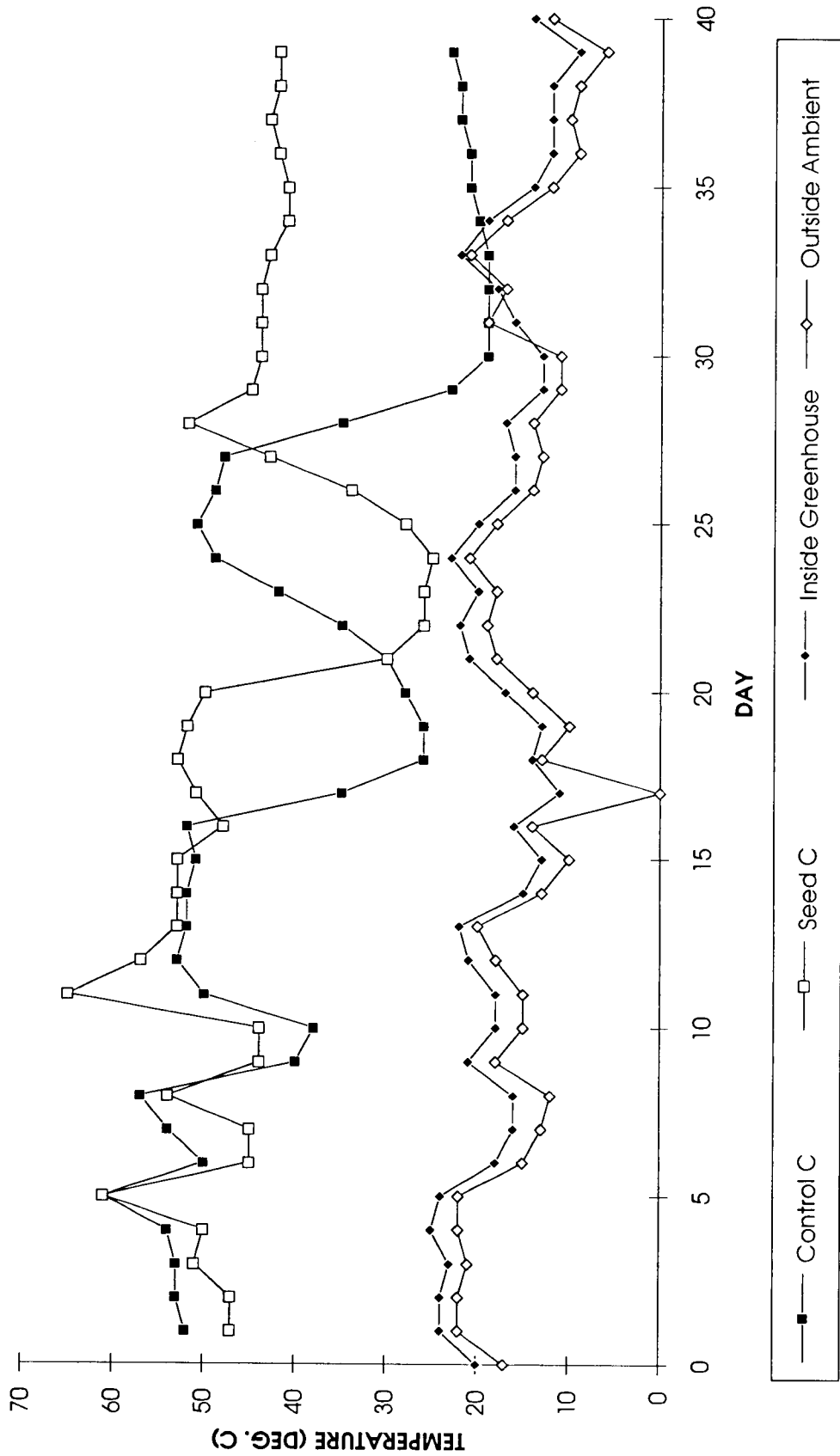

FIGURE 5-3 COMPOST AND AMBIENT TEMPERATURES FOR SEEDING STUDY C

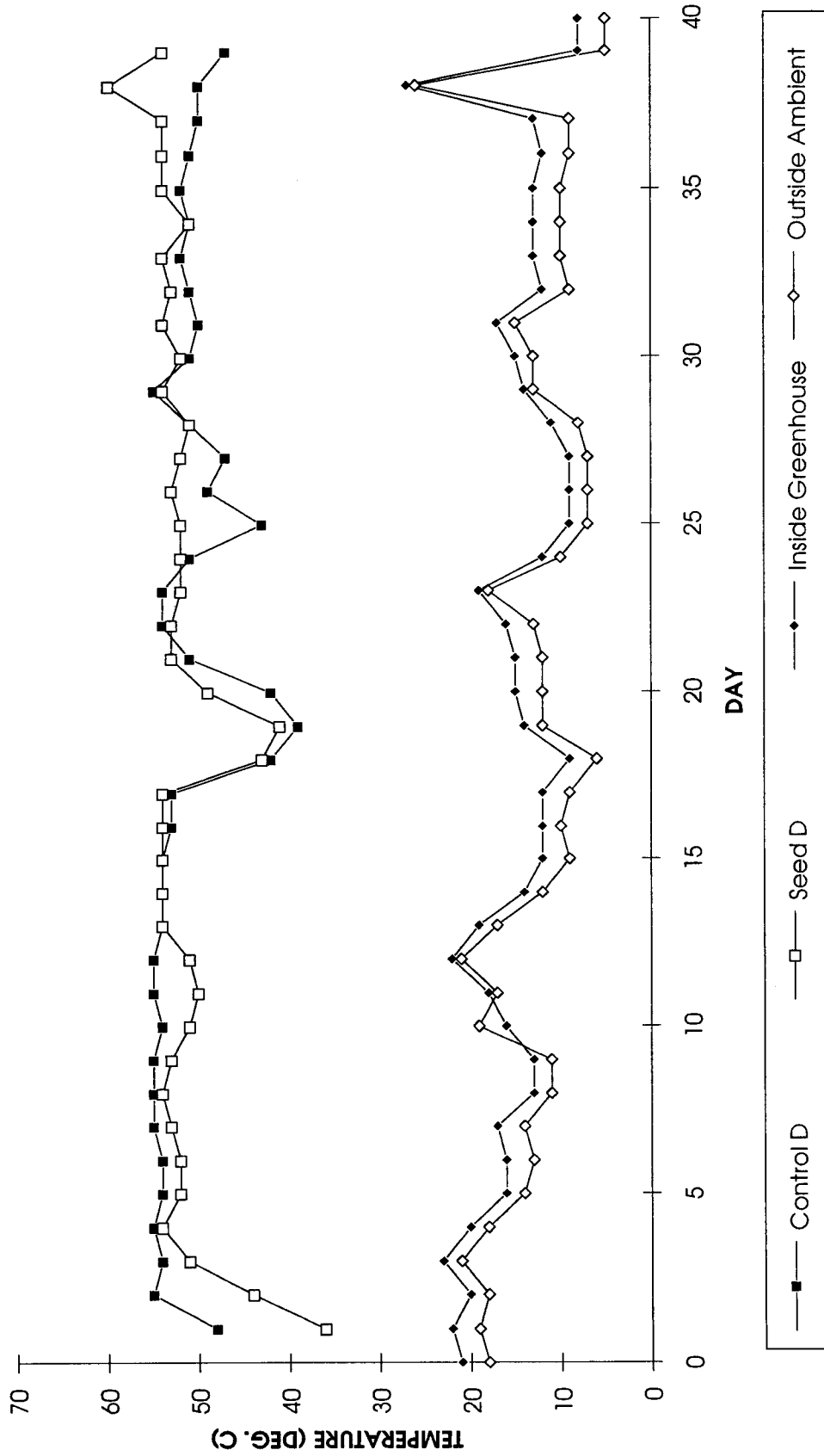

FIGURE 5-4 COMPOST AND AMBIENT TEMPERATURES FOR SEEDING STUDY D

5.1.2 OXYGEN

Interstitial oxygen levels within the static tanks were maintained in the process of controlling temperature. During periods in which temperature was stable and cooling was unnecessary, oxygenation was provided by intermittent aeration cycles, which provided periodic bursts of air to the tanks. Oxygen was monitored twice per week at the top, middle, and bottom of each active reactor. The averages of these three readings were calculated and are presented in the oxygen profile plots in Figures 5-5 through 5-8.

In general, interstitial oxygen levels were maintained between 15% and 20% oxygen by volume as measured with the hand-held meter, with occasional temporary drops resulting from blower malfunctions associated with the control system upsets. As might be expected under this mode of operation, differences in average interstitial oxygen levels among series of tests and between seed and control reactors within a series are not apparent. The likely effect of recycle on oxygen consumption, if any, would be an increase in the initial oxygen consumption rate. Because changes in explosives removal performance were the primary criteria in these tests, independent measurements of oxygen uptake rates were not conducted.

5.1.3 pH

Figures 5-5 through 5-8 also present the pH profiles of the seeding studies. Although the exact shape of the graphs differed from test to test, the general trend of the tanks was toward increasing pH throughout the 40-day duration of the test. These observations are generally consistent with previous experience [1]. Variability in initial pH was observed, which may reflect variability in amendment characteristics. No clearly discernible effect of compost recycle on pH is apparent.

5.1.4 MOISTURE CONTENT

The moisture content profiles for the seeding studies are presented in Figures 5-5 through 5-8. Moisture levels were maintained manually through periodic additions with a garden hose, based upon moisture measurements taken weekly and upon visual inspections of the compost. Maintenance of moisture levels in an aerated static pile is complicated by the drying effect of the aeration system. In addition, the inability to mix the static pile makes it more difficult to maintain a homogenous moisture level throughout the pile. Nevertheless, the tests showed only a slight decrease in moisture over the duration of the study.

The values presented in Figures 5-5 through 5-8 represent the average of three standard percent moisture (wet basis) measurements taken from each tank for each sampling interval. However, the decision to add water to tanks was based upon a calculation of moisture called percent water-holding capacity. This calculation was

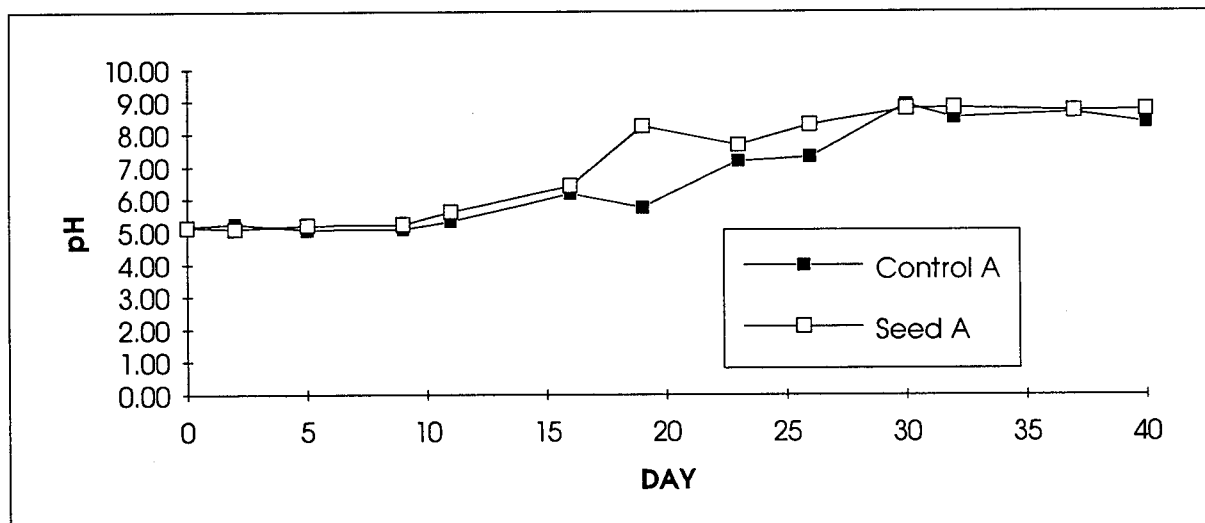
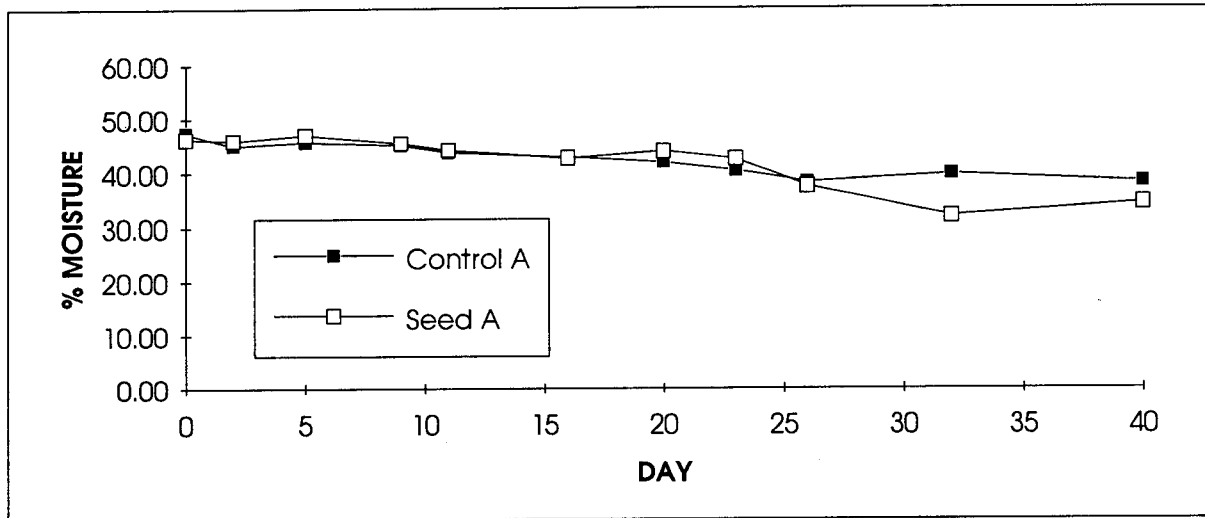
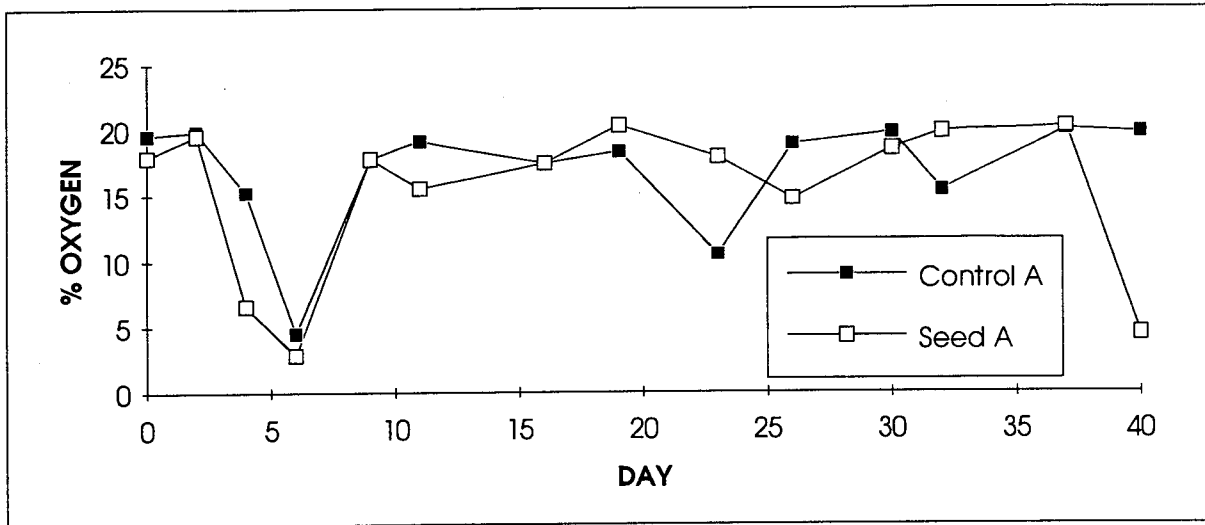

FIGURE 5-5 OXYGEN, MOISTURE, AND pH PROFILES FOR SEEDING STUDY A

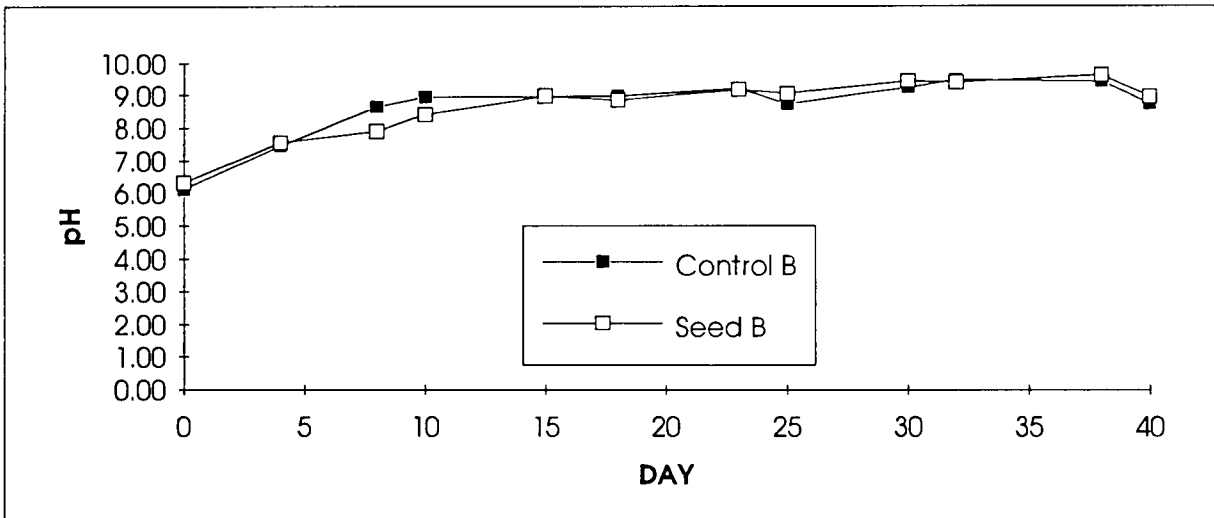
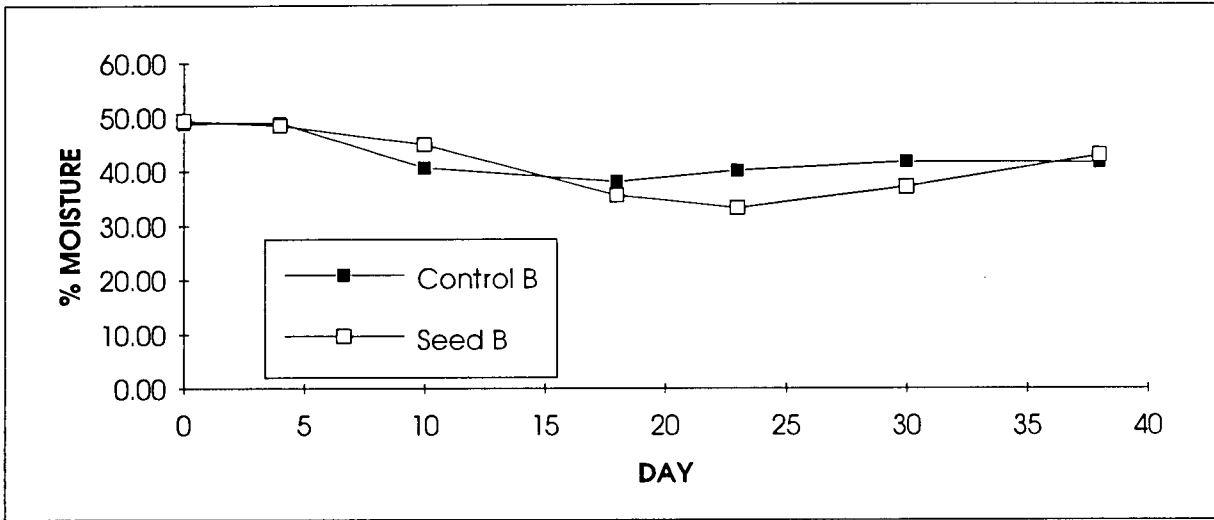
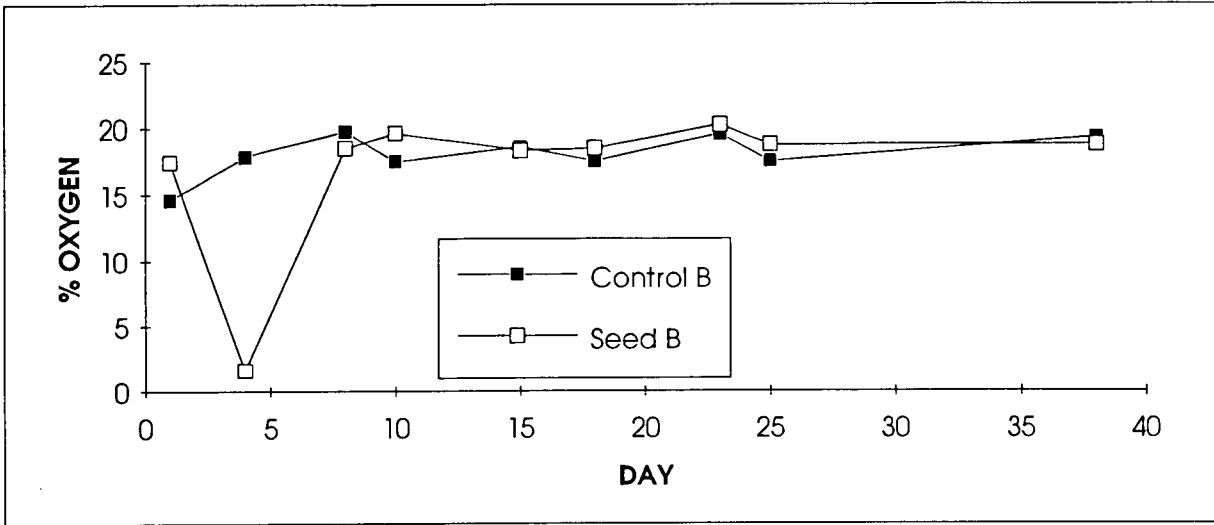

FIGURE 5-6 OXYGEN, MOISTURE, AND pH PROFILES FOR SEEDING STUDY B

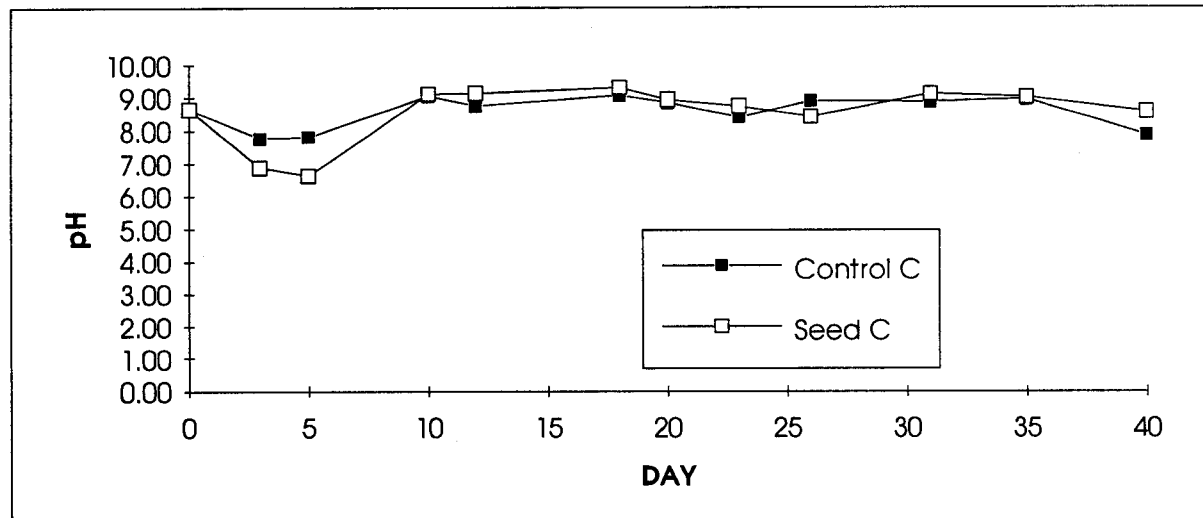
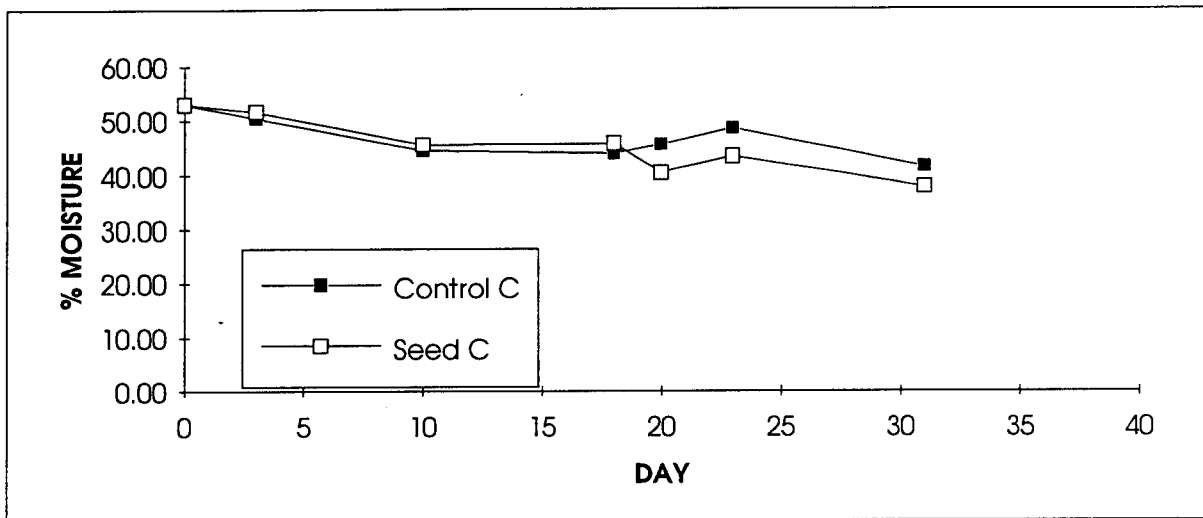
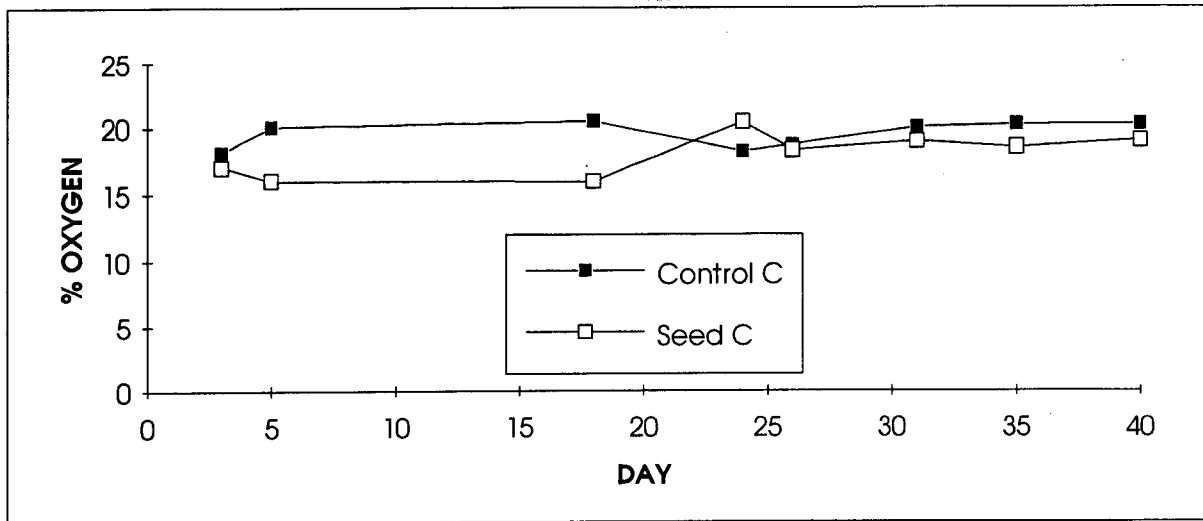

FIGURE 5-7 OXYGEN, MOISTURE, AND pH PROFILES FOR SEEDING STUDY C

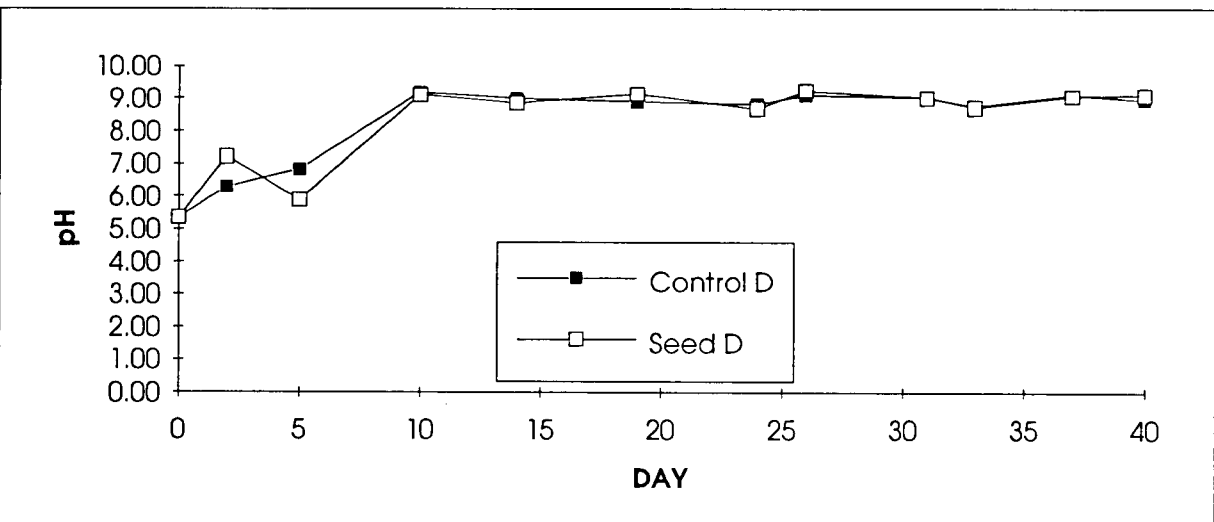
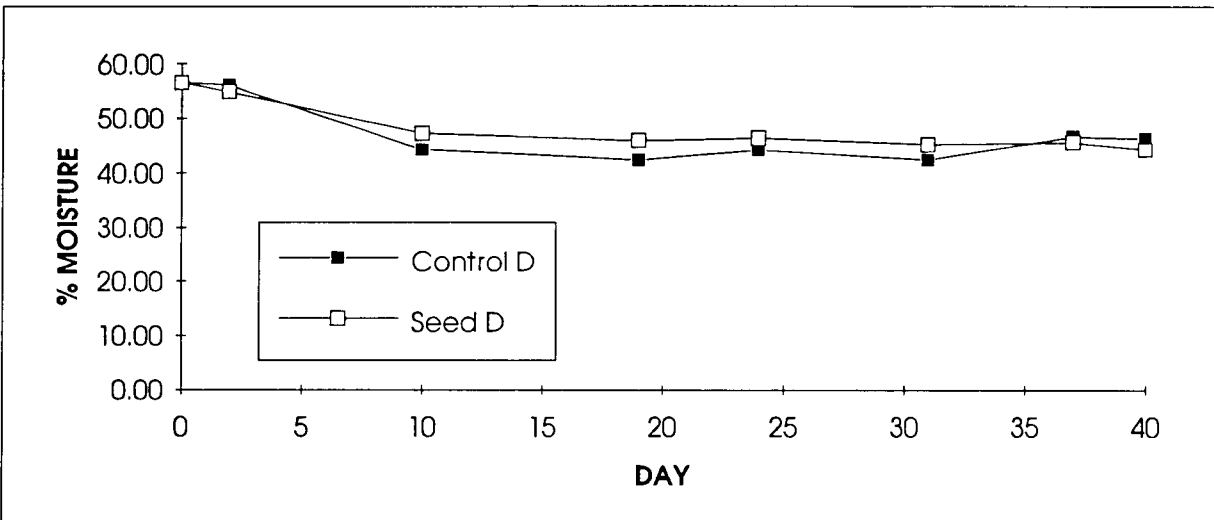
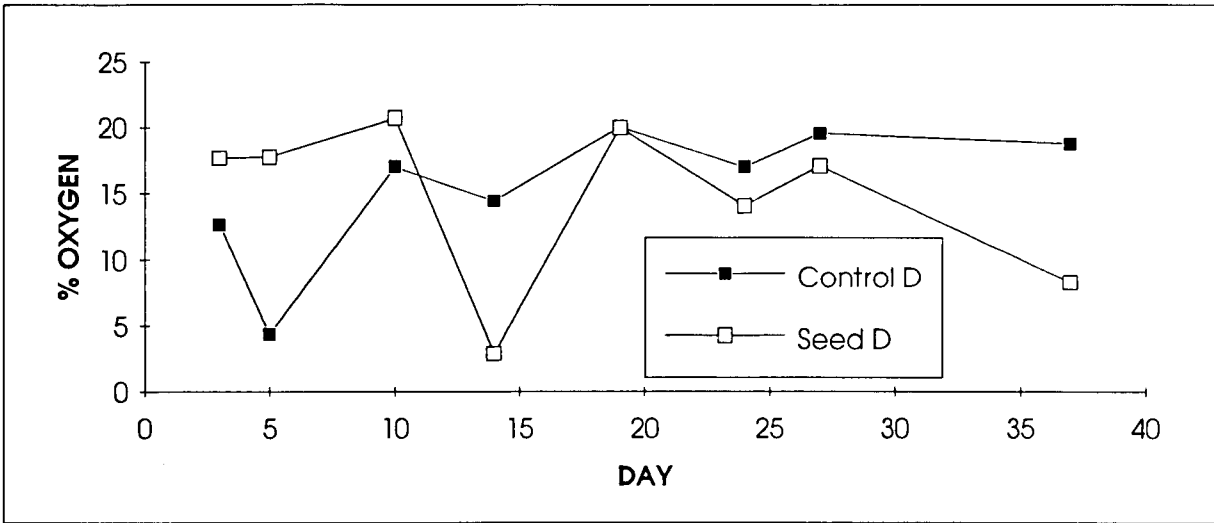

FIGURE 5-8 OXYGEN, MOISTURE, AND pH PROFILES FOR SEEDING STUDY D

performed in the field, as shown in Appendix B, and was maintained between 50 and 80% WHC throughout all four seeding studies.

5.1.5 MICROBIOLOGY RESULTS

Microbiological and biochemical analyses were conducted during the seeding study to assess overall microbial activity. The majority of these data will be discussed in a separate report. Table 5-1 presents the available data for total aerobic and anaerobic bacteria, obligate anaerobes, and thermophilic bacteria for all seed study reactors. It might be noted that bacterial plate count methods from which these data were developed are quantitatively accurate to order-of-magnitude levels. Comparison among test series suggests that the seed material did not result in substantial increases in total microbial levels. Furthermore, total microbial levels in control reactors were essentially the same as in seed reactors.

5.1.6 EXPLOSIVES DEGRADATION

Table 5-2 presents the average explosives concentrations for each sampling interval for each test conducted as part of the seeding composting study. When calculating these average values, any values that were measured below analytical detection limits (indicated by "J" in the raw data - see Appendix F) were used directly in the calculation. For samples in which the analyte was not detected (indicated by "U" in the raw data - see Appendix F), one half of the lower detection limit as presented in the raw data was used in the calculation. Although the detection limits for the method are constant, slight variations in the weights of aliquots used in the extraction resulted in slight variations in lower detection limits from sample to sample.

The primary explosives of concern in the seeding study were HMX, RDX, and TNT. The samples were also analyzed for trinitrobenzene (1,3,5-TNB) and the two isomers of dinitrotoluene (2,6-DNT and 2,4-DNT); however, for the most part, these analytes were detected below detection limits or were not detected at all (see Appendix F). As a result, graphical presentations of explosives data have been limited to the three principal explosives HMX, RDX and TNT.

Figures 5-9 through 5-12 present the concentrations of the principal explosives in each study over time. Because the initial concentrations of the explosives varied somewhat from study to study, the percent reduction of each explosive was calculated for each test to allow the comparison of removal efficiency among studies. These data are presented graphically in Figures 5-13, 5-14, and 5-15. Table 5-3 summarizes the overall removals attained for each explosive over the 40-day duration of each test. In general, the Control A and Seed A tests showed less reduction at each sampling interval than the subsequent tests.

The removal trends for TNT and HMX do not seem to indicate better performance of seed reactors than control reactors. For RDX, successive seed reactors exhibited consistently higher removal rates; however, the overall reduction in RDX was greater in the control reactors.

Table 5-1

**Bacteria Population Levels for Seeding Study
(All Units are CFU*/g of Compost)**

Vessel	Day	Total Aerobic Bacteria	Total Anaerobic Bacteria	Thermophilic Bacteria	Obligate Anaerobic Bacteria
Control A	0	10 ³	10 ³	10 ⁵	10 ³
	20	10 ⁸	10 ⁸	10 ⁵	10 ²
Seed A	0	10 ⁴	10 ⁴	10 ⁶	10 ³
	20	10 ⁸	10 ⁸	10 ³	10 ²
Control B	0	10 ⁸	10 ⁸	10 ²	10 ³
	20	---	---	---	---
Seed B	0	10 ⁸	10 ⁸	10 ³	10 ³
	20	---	---	---	---
Control C	0	---	---	---	---
	20	10 ⁸	10 ⁸	10 ³	10 ²
Seed C	0	---	---	---	---
	20	10 ⁵	10 ⁵	10 ³	10 ²
Control D	0	10 ³	10 ³	10 ⁵	10 ²
	20	---	---	---	---
Seed D	0	10 ³	10 ³	10 ²	10 ²
	20	---	---	---	---

--- = Indicates no data available.

*CFU = Colony Forming Units.

Table 5-2
Average¹ Explosives Concentrations for the Seeding Study

Test	Day	2,4,6-TNT ($\mu\text{g/g}$)	RDX ($\mu\text{g/g}$)	HMX ($\mu\text{g/g}$)	1,3,5-TNB ($\mu\text{g/g}$)	2,6-DNT ($\mu\text{g/g}$)	2,4-DNT ($\mu\text{g/g}$)
Control A	0	1,024	1,250	251	2.06	0.42	1.83
	10	257	897	159	2.09	0.70	0.91
	20	112	855	172	2.10	0.60	0.68
	40	36	297	106	2.08	0.40	0.42
Control B	0	3,868	1,788	417	3.23	0.39	1.79
	10	84	989	220	2.12	0.41	0.42
	20	50	861	245	2.06	0.39	0.41
	40	27	433	180	2.14	0.41	0.43
Control C	0	5,492	2,132	466	3.74	0.41	3.02
	10	65	786	224	2.10	0.40	0.42
	20	42	350	155	2.08	0.40	0.42
	40	44	511	188	2.10	0.40	0.42
Control D	0	4,424	1,586	361	3.81	0.41	3.33
	10	151	956	207	2.10	0.40	0.65
	20	79	596	194	2.10	0.40	0.42
	40	13	100	138	2.10	0.40	0.42

Table 5-2
Average¹ Explosives Concentrations for the Seeding Study
(Continued)

Test	Day	2,4,6-TNT ($\mu\text{g/g}$)	RDX ($\mu\text{g/g}$)	HMX ($\mu\text{g/g}$)	1,3,5-TNB ($\mu\text{g/g}$)	2,6-DNT ($\mu\text{g/g}$)	2,4-DNT ($\mu\text{g/g}$)
Seed A	0	863	1,180	243	2.07	0.40	1.66
	10	184	976	169	2.10	0.67	0.75
	20	109	845	176	2.10	0.50	0.56
	40	74	494	156	2.06	0.40	0.42
Seed B	0	2,622	1,596	393	2.13	0.40	1.32
	10	199	1,050	229	2.07	0.40	0.42
	20	70	795	227	2.08	0.40	0.42
	40	42	586	209	2.13	0.41	0.43
Seed C	0	3,788	1,838	415	2.67	0.40	2.41
	10	82	1,168	260	2.07	0.40	0.42
	20	43	562	208	2.14	0.41	0.43
	40	14	466	234	2.13	0.41	0.43
Seed D	0	3,604	1,388	317	4.09	0.40	2.68
	10	214	736	176	2.13	0.41	0.76
	20	111	377	167	2.10	0.40	0.42
	40	17	101	133	2.10	0.40	0.42

¹Calculation of averages included actual values present below detection limits (J values) and one-half lower detection limit for non-detected (U values).

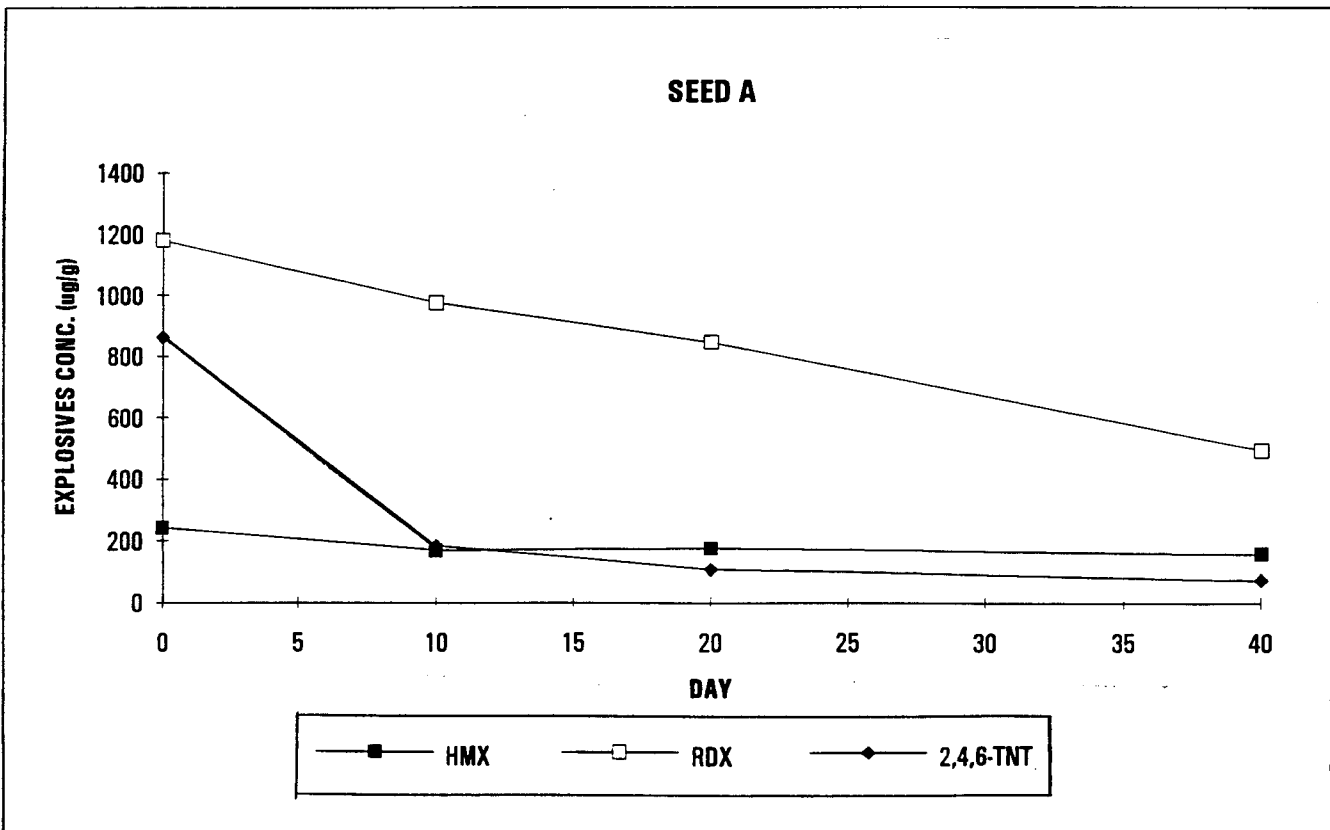
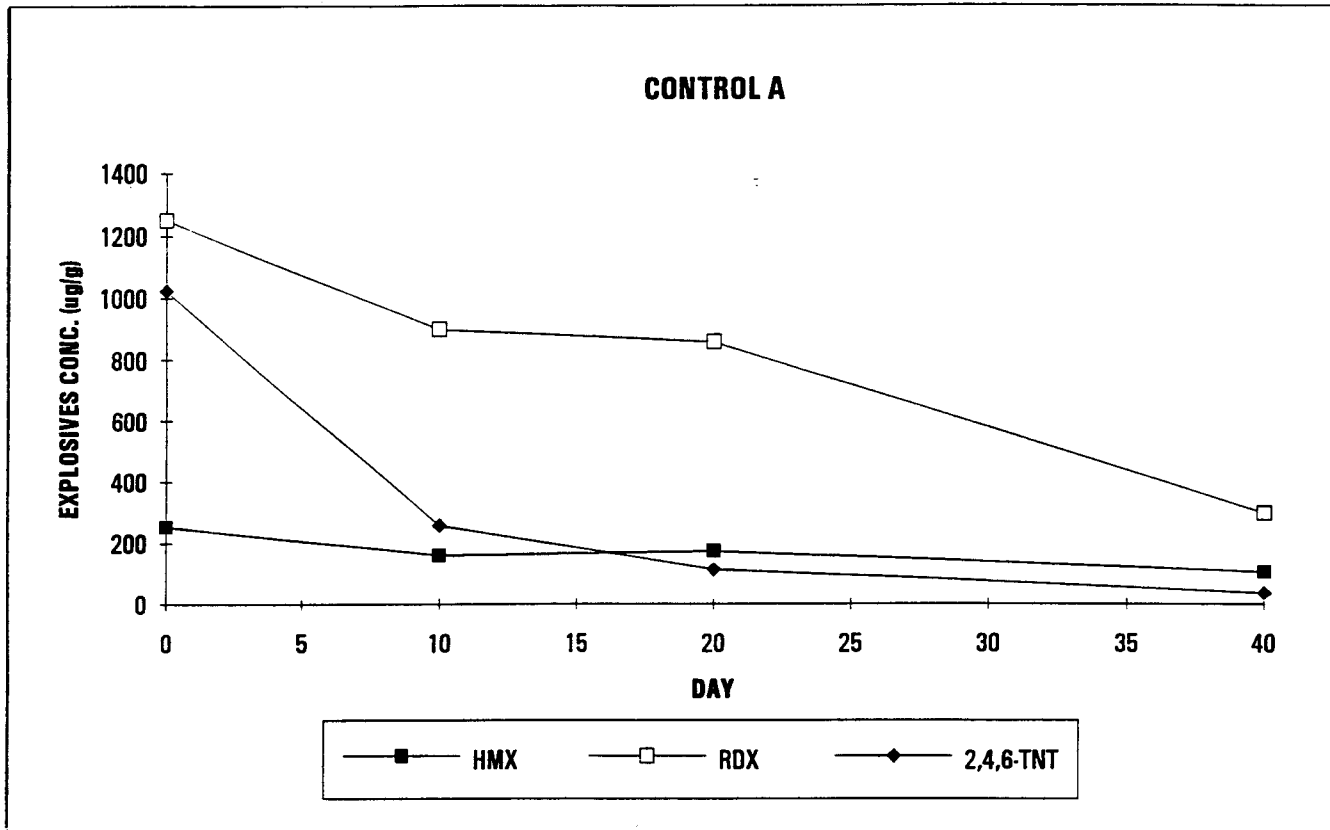

FIGURE 5-9 EXPLOSIVES CONCENTRATIONS VS. TIME FOR SEEDING STUDY A

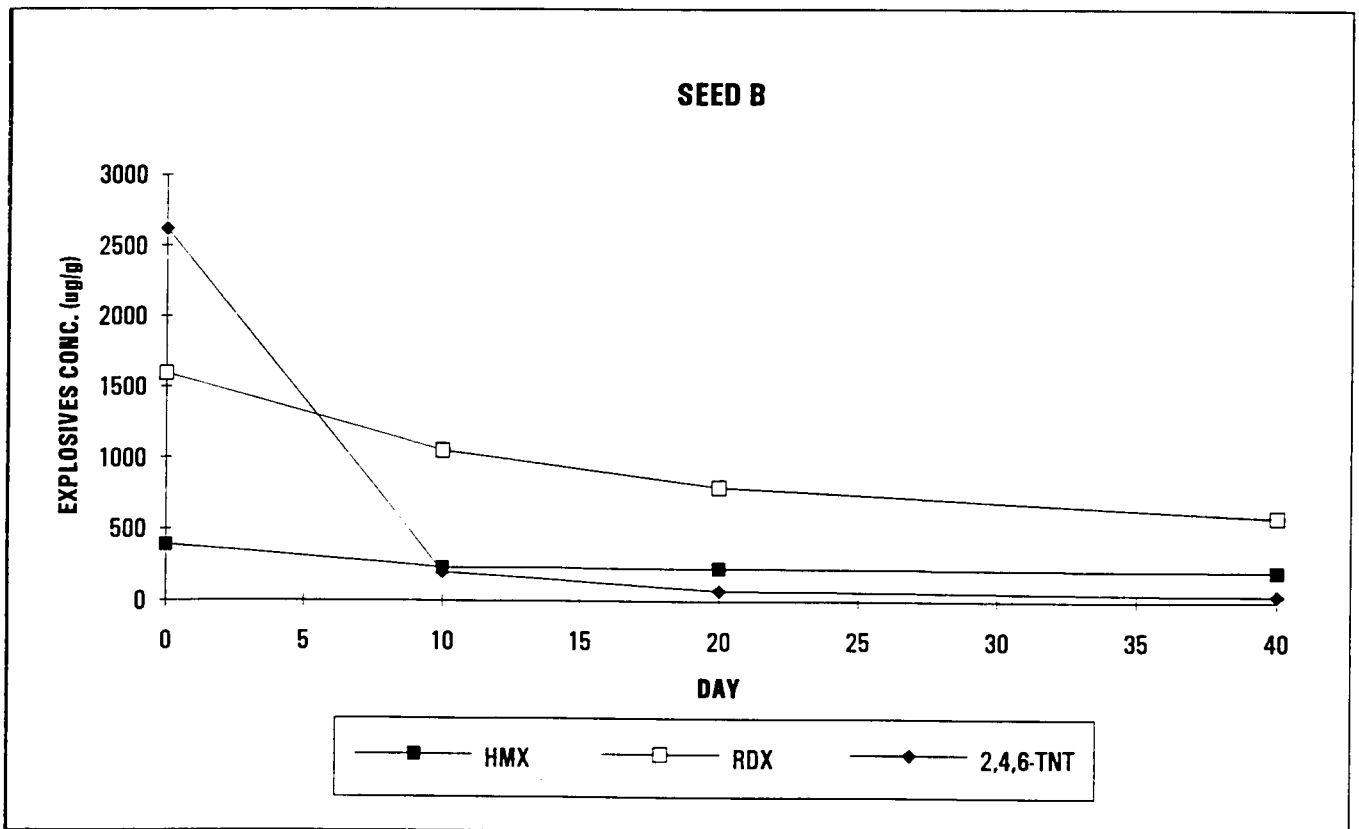
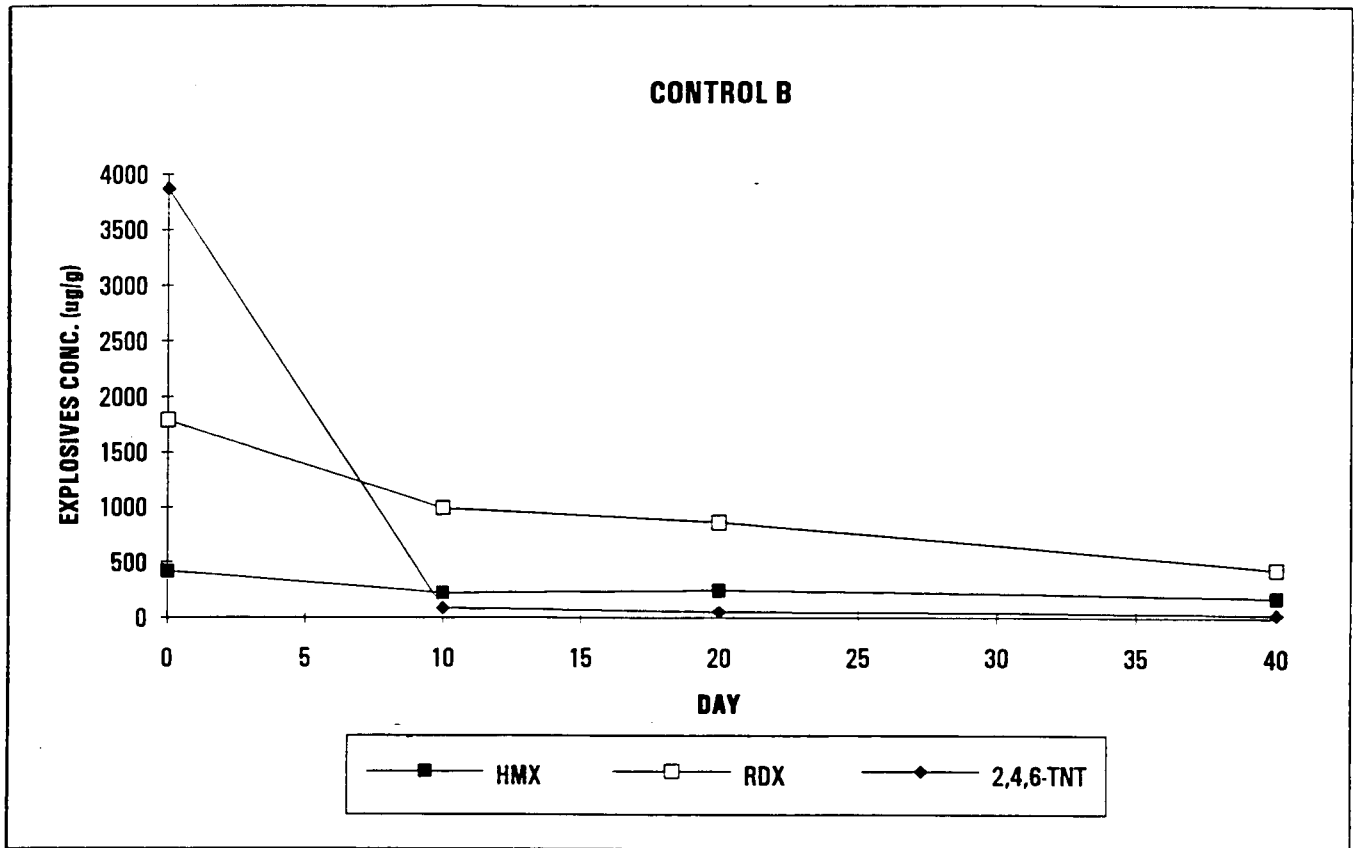

FIGURE 5-10 EXPLOSIVES CONCENTRATIONS VS. TIME FOR SEEDING STUDY B

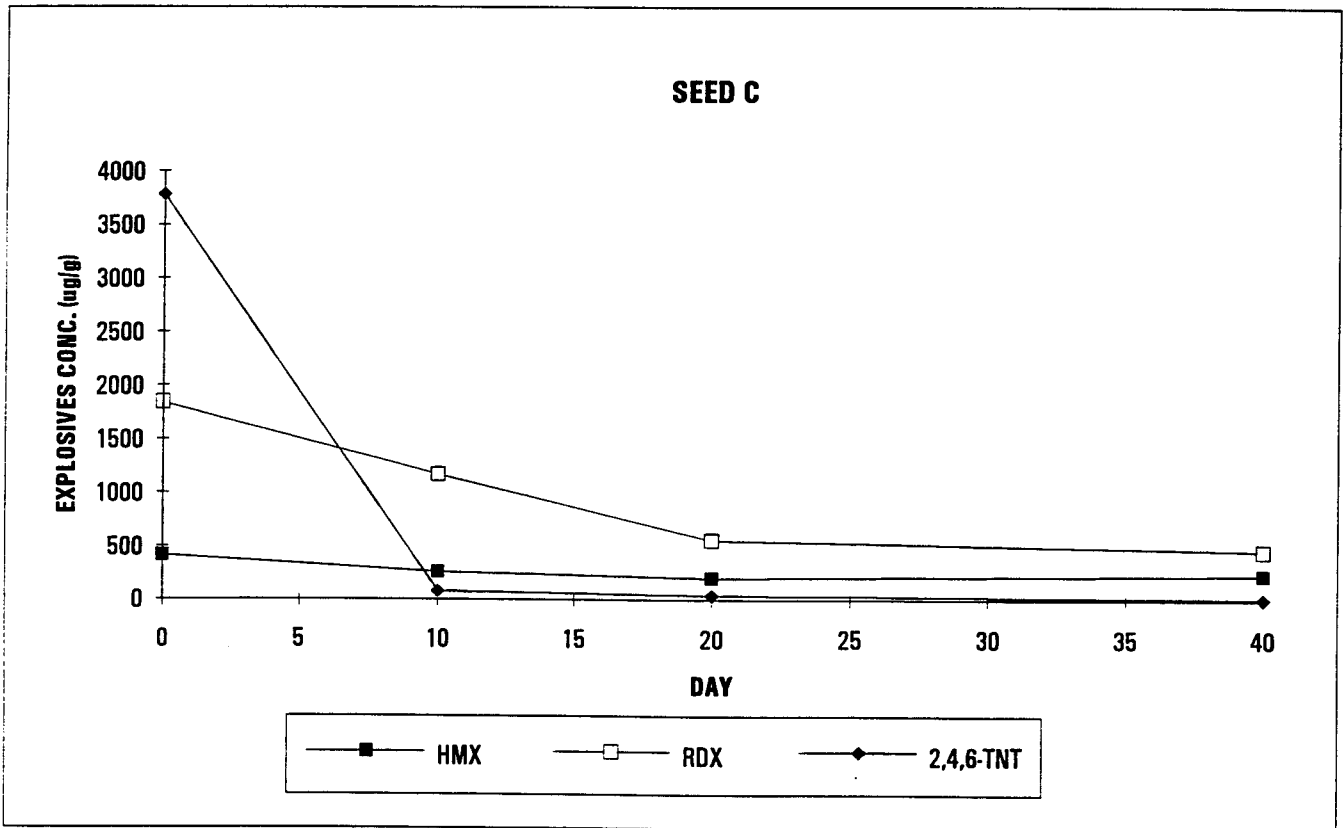
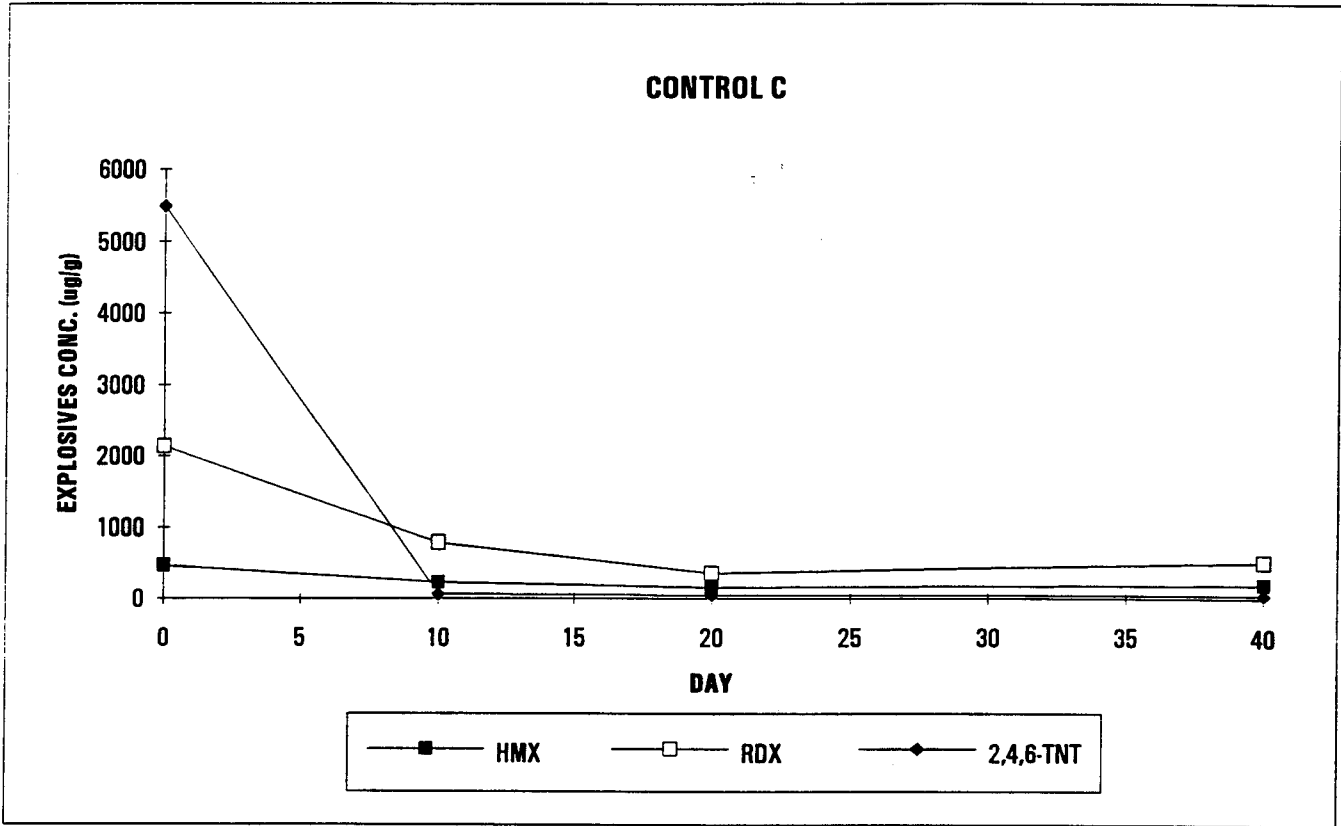

FIGURE 5-11 EXPLOSIVES CONCENTRATIONS VS. TIME FOR SEEDING STUDY C

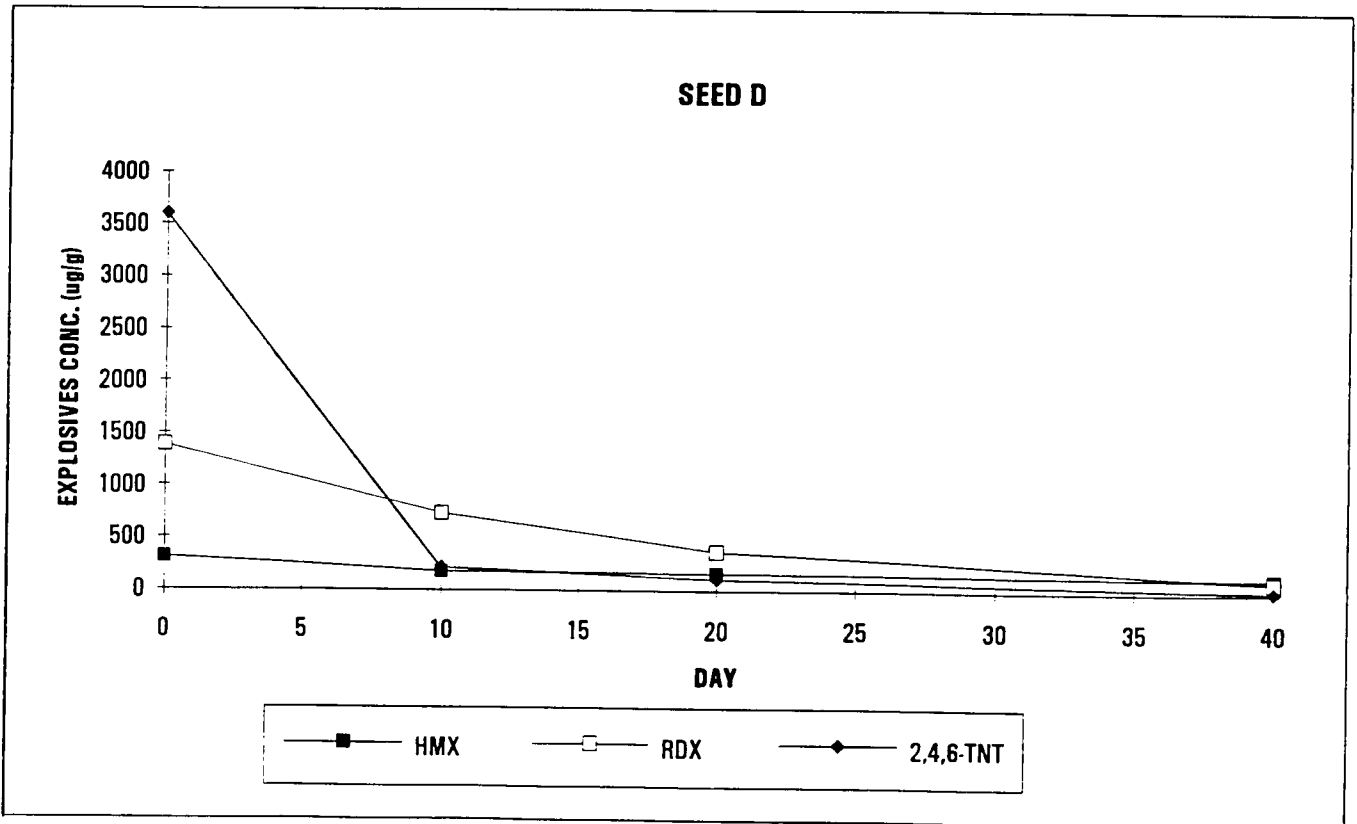
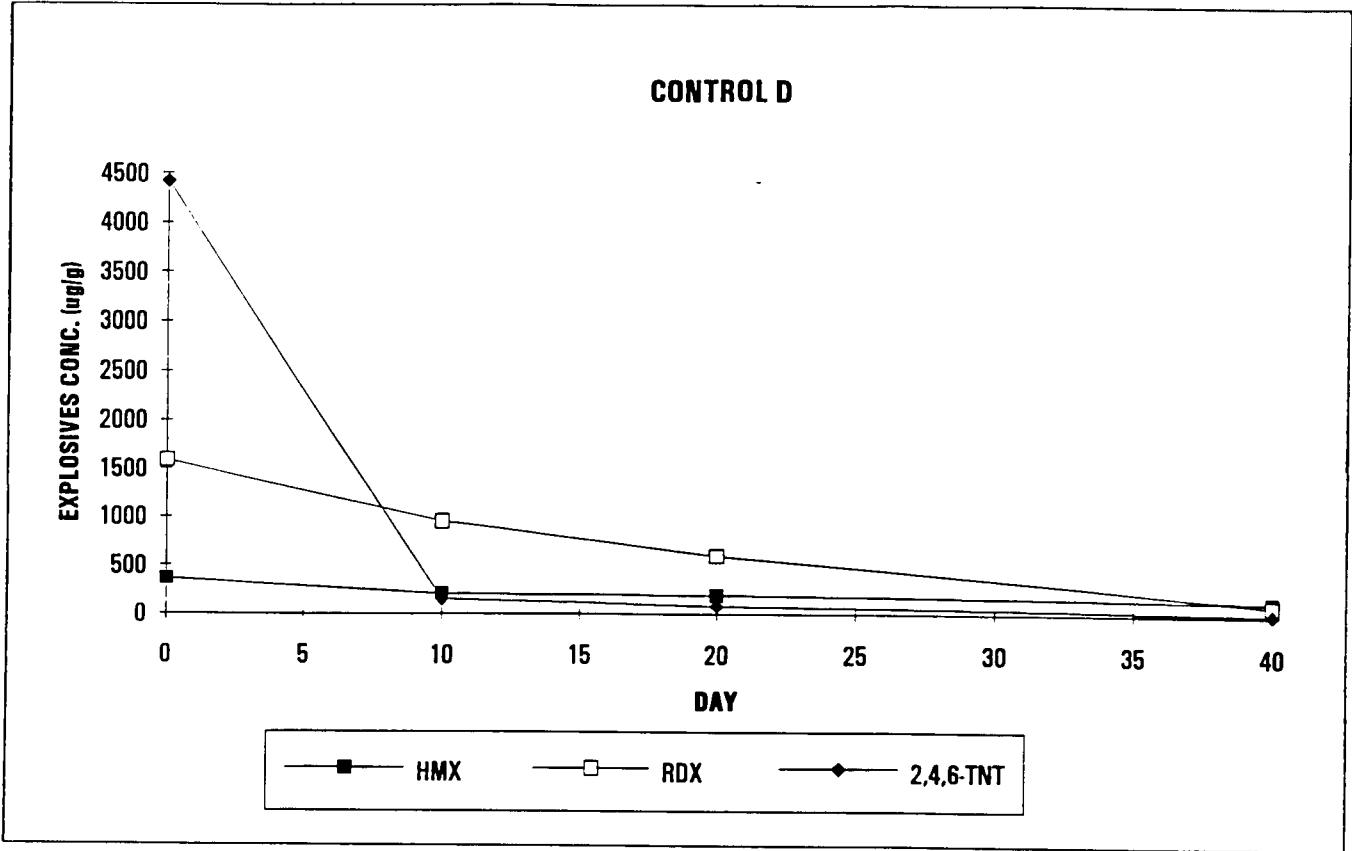

FIGURE 5-12 EXPLOSIVES CONCENTRATIONS VS. TIME FOR SEEDING STUDY D

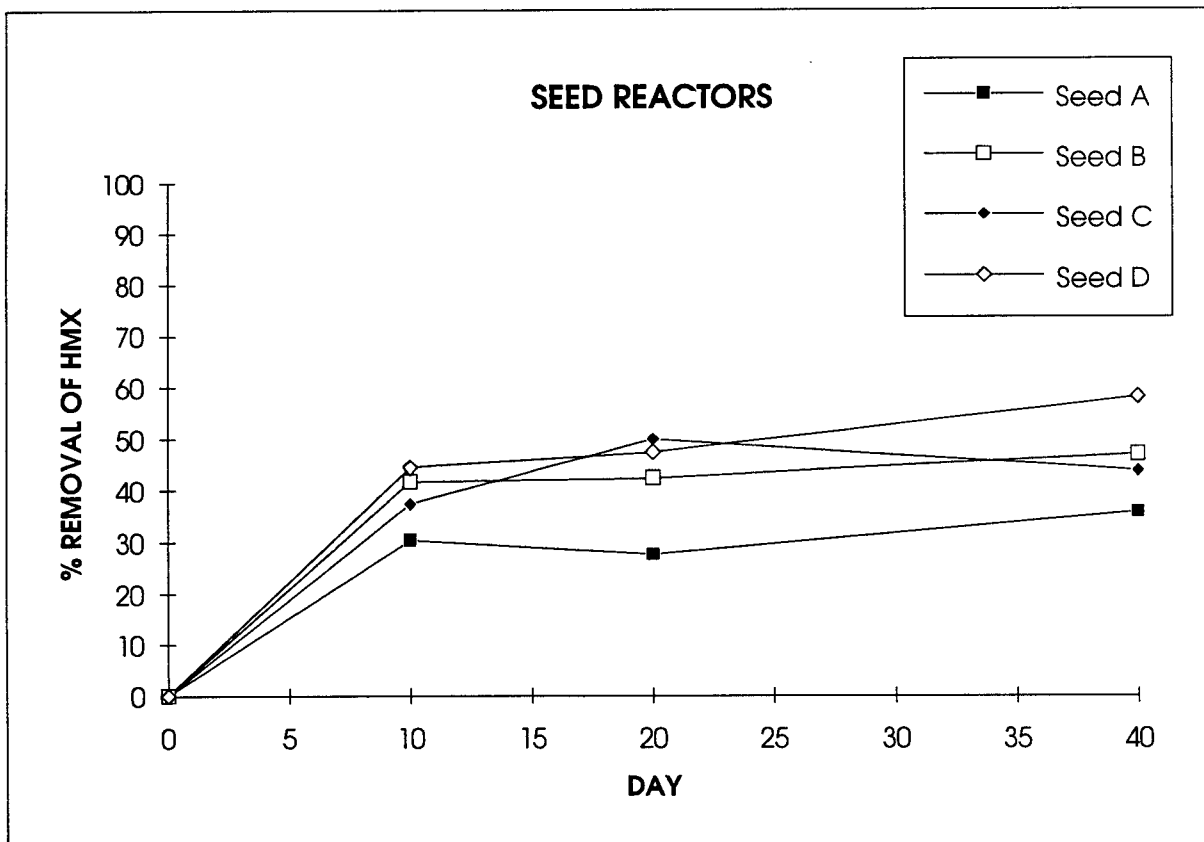
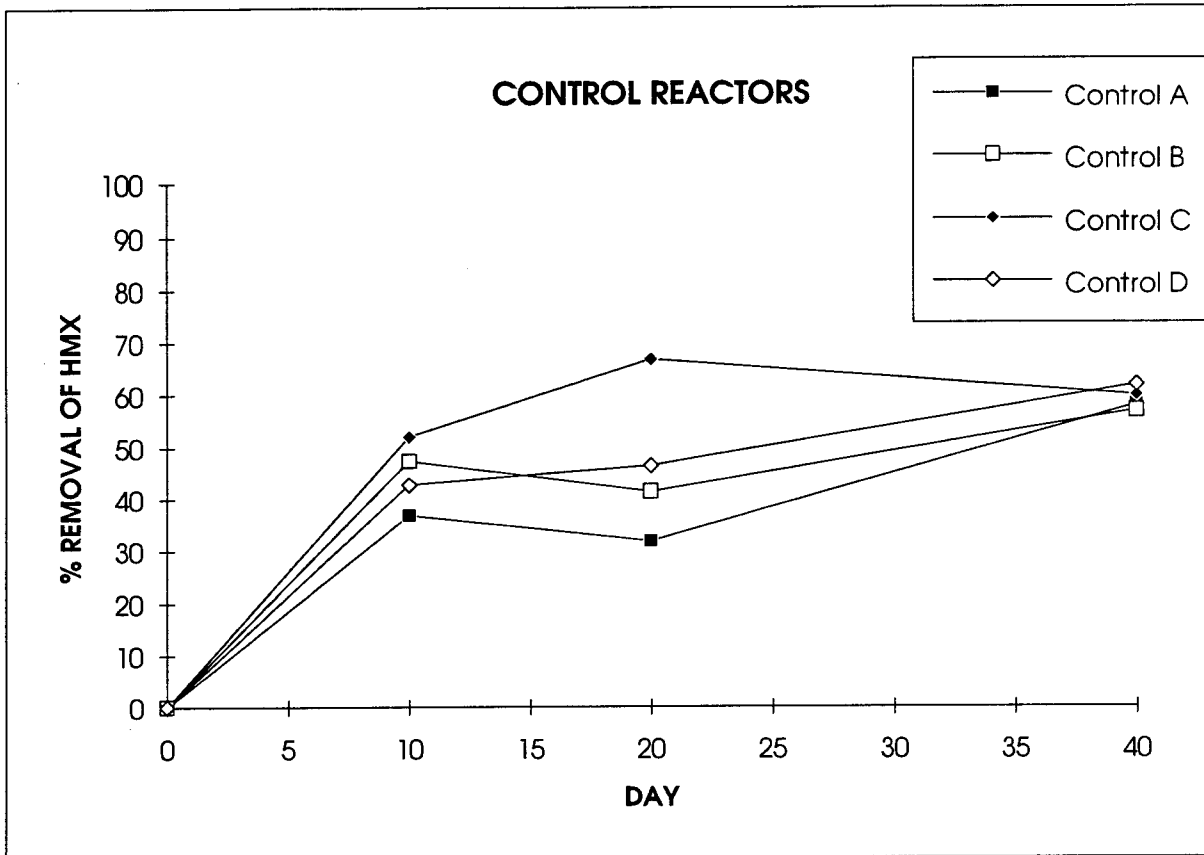

FIGURE 5-13 PERCENT REMOVAL OF HMX FOR SEEDING STUDY

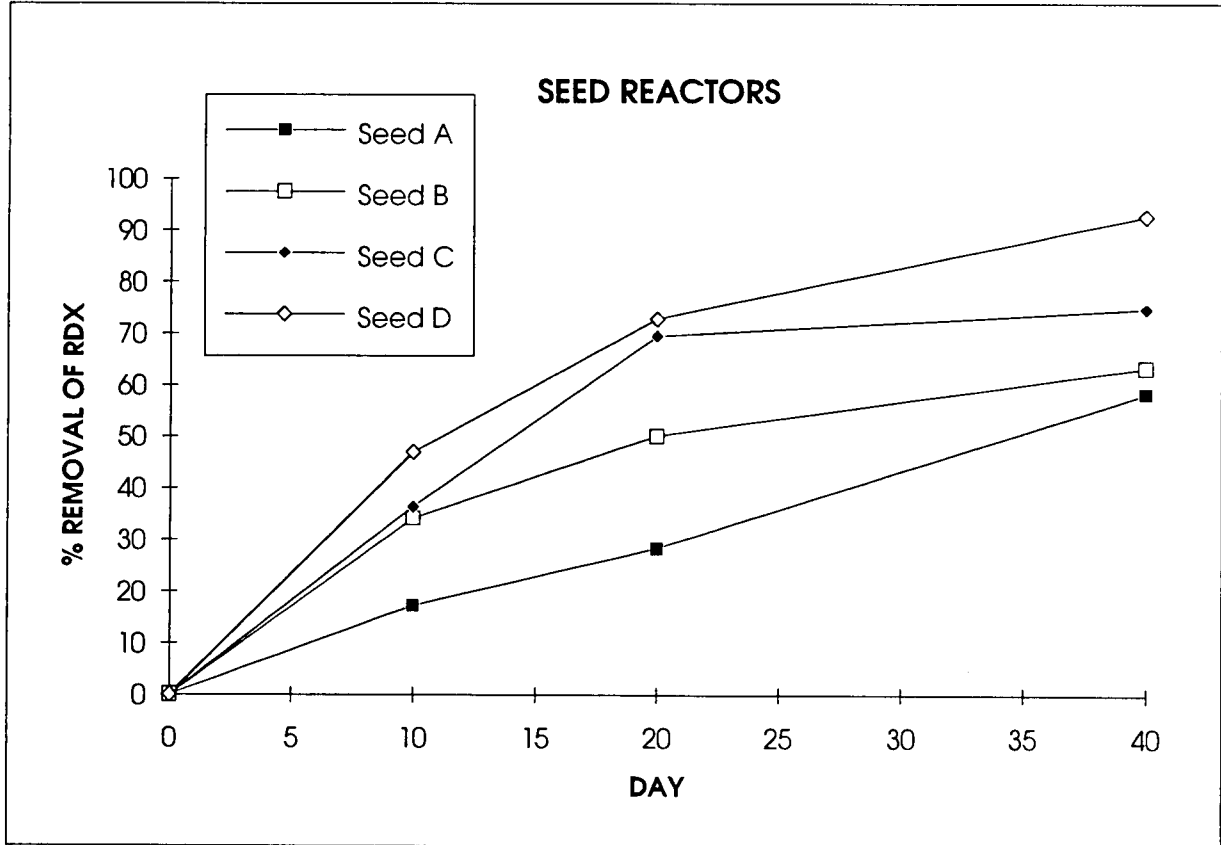
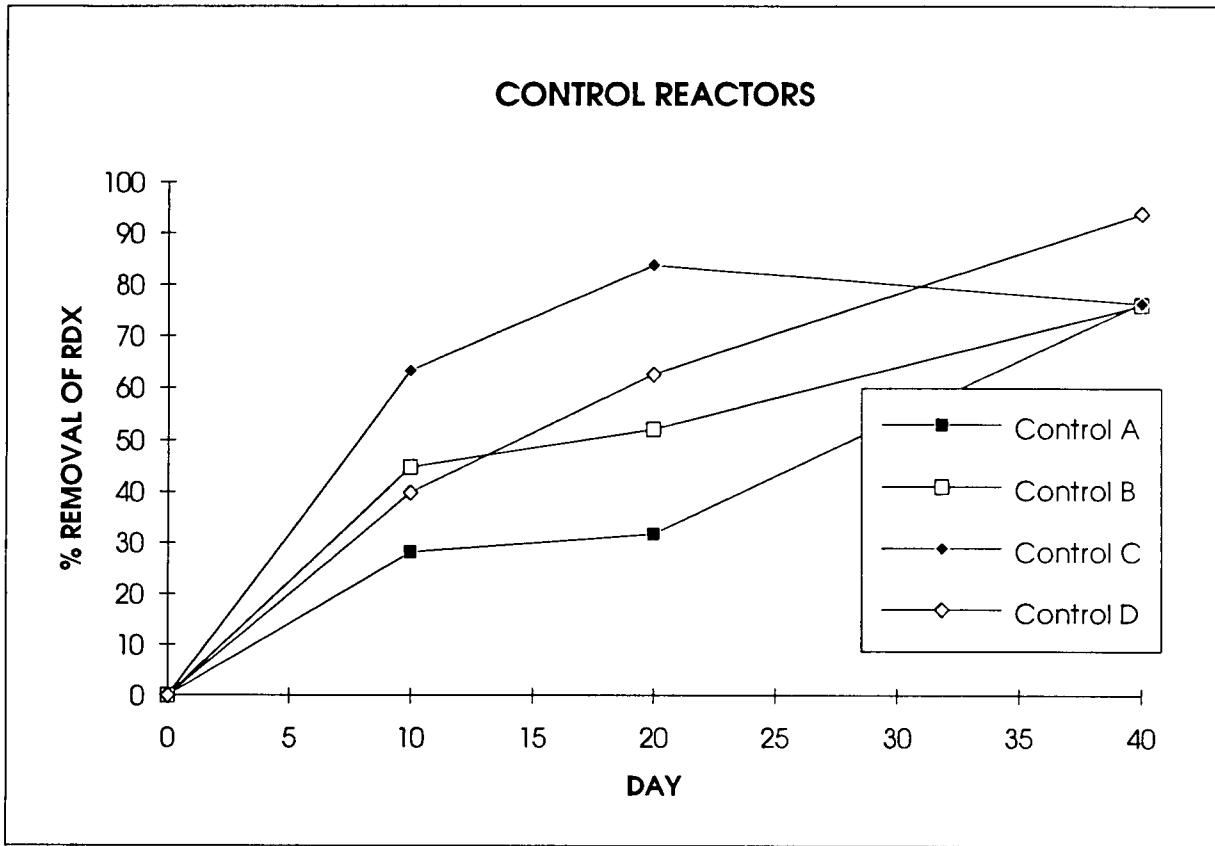

FIGURE 5-14 PERCENT REMOVAL OF RDX FOR SEEDING STUDY

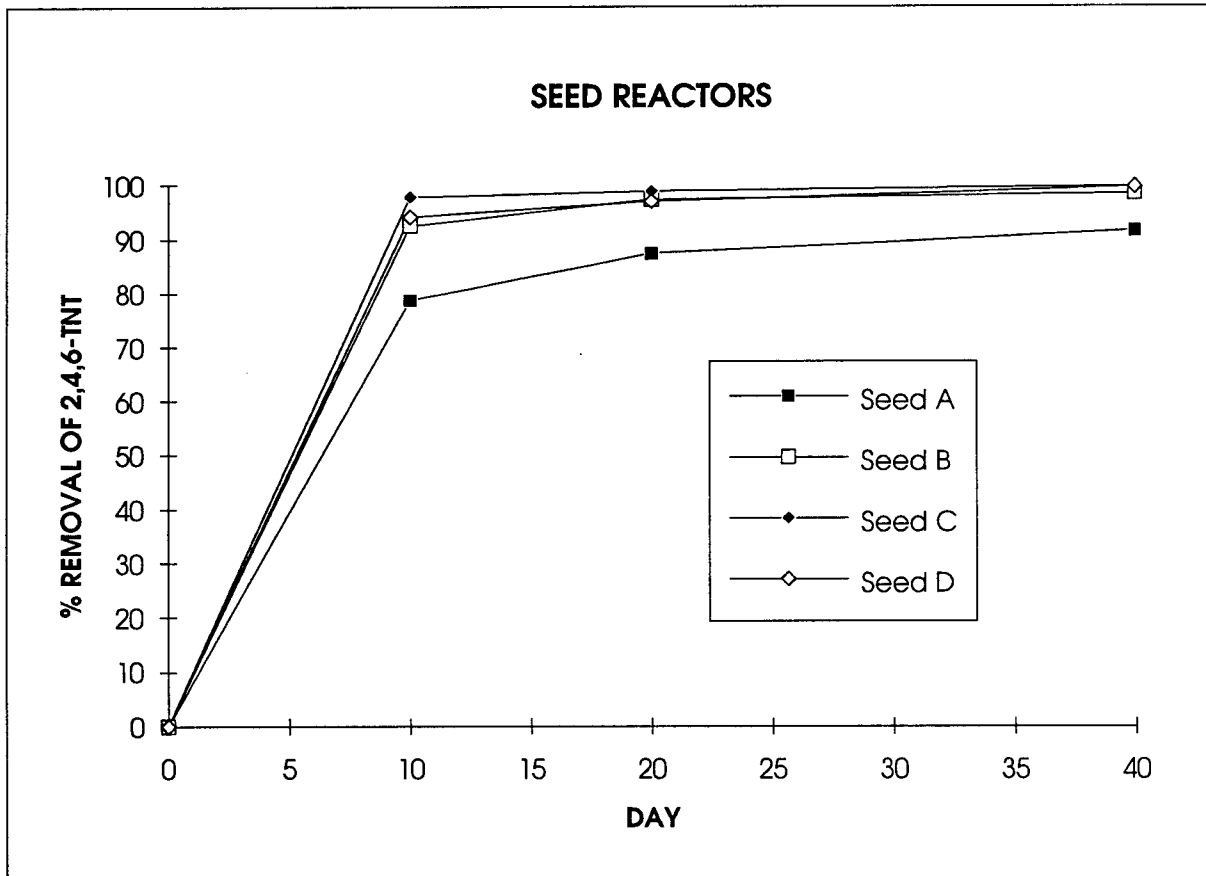
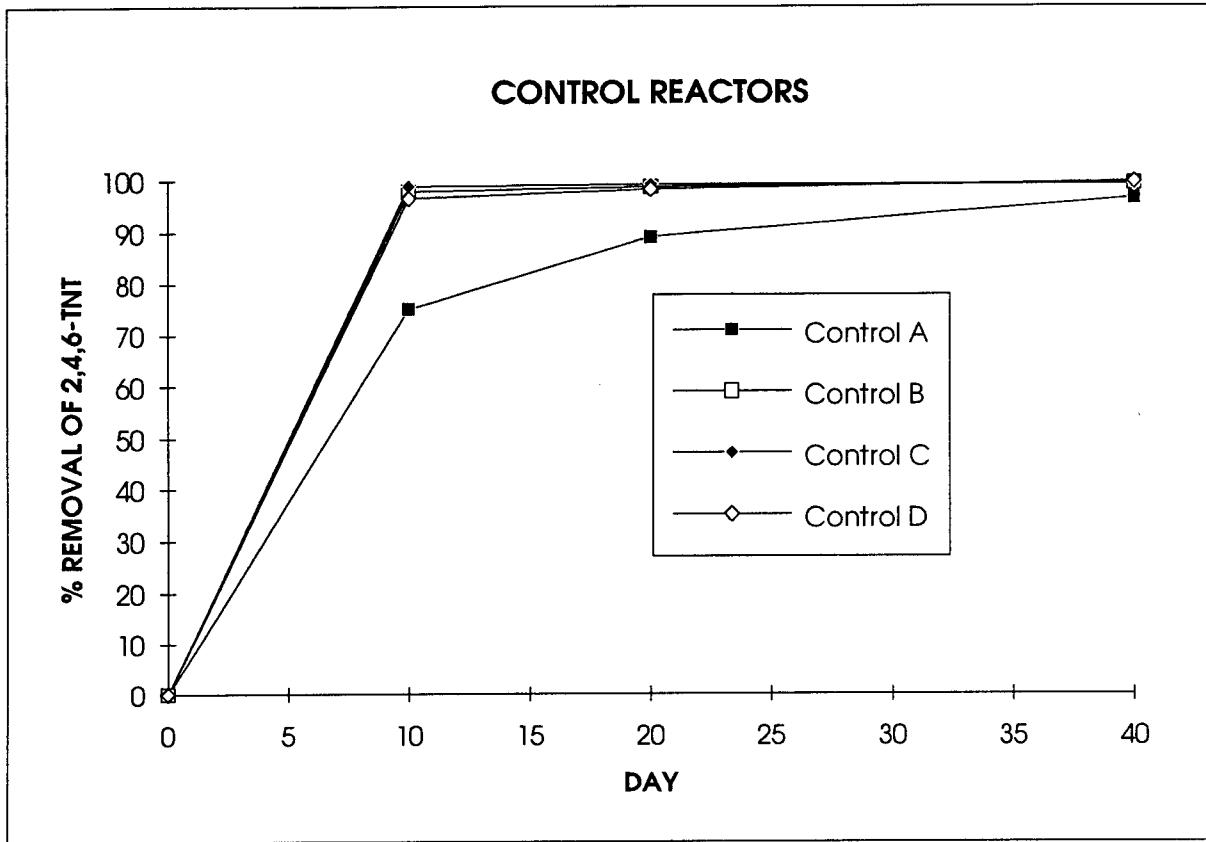

FIGURE 5-15 PERCENT REMOVAL OF 2,4,6-TNT FOR SEEDING STUDY

Table 5-3

**Seeding Study 40-Day Explosives Removal and TNT
Reaction Kinetics Summary**

Test	Primary Explosives (% Removal)			Regression Results (TNT)	
	TNT	RDX	HMX	K-Value (days ⁻¹)	R-Squared
Control A	96.5	76.3	58.0	-0.081	0.953
Seed A	91.4	58.1	35.8	-0.056	0.782
Control B	99.3	75.8	56.8	-0.107	0.670
Seed B	98.4	63.3	46.9	-0.095	0.771
Control C	99.2	76.0	59.7	-0.100	0.522
Seed C	99.6	74.6	43.7	-0.125	0.763
Control D	99.7	93.7	61.8	-0.132	0.861
Seed D	99.5	92.7	58.0	-0.123	0.093

Based upon observed removal of TNT, HMX, and RDX, beneficial effects of the recycle operation as conducted in these tests are not apparent.

5.1.7 KINETICS

The explosives removal data for the seeding study were evaluated under the assumption of a first order rate relationship with respect to contaminant concentration, represented mathematically as $C = C_0 e^{-kt}$, where:

- C = concentration of constituent at time t
- C_0 = initial concentration of the constituent
- t = time
- k = first order rate coefficient (K-value)

While the above expression adequately describes biological treatment of soil-bound contaminants, it is not universally applicable. The nature of this model does not allow for or incorporate a lag phase (as was observed for HMX and RDX) or other similar effects.

To evaluate whether this equation can be used to accurately predict explosives removals over time due to aerated static pile composting, a regression analysis was performed on the TNT data, because it exhibited no apparent lag phase.

The results of this analysis are present in Table 5-3. Both the K-values predicted by the regression and the R^2 (coefficient of determination) values are presented in this table for comparison with previous reports [1, 10]. To better illustrate the accuracy of the regression equations, graphs of the TNT concentrations vs. time along with the lines defined by the regression analysis are presented in Appendix G. The graphs and R^2 values appear to indicate that a simple first order relationship may not adequately describe the kinetics in an aerated static pile composting system. Regression lines appear to underestimate the removals achieved during the first 30 days of composting and thus do not appear to provide a reliable method for predicting explosives removals.

5.2 RESULTS OF WINDROW STUDIES

5.2.1 UNCONTAMINATED WINDROWS 1 & 2 (UWR1 & UWR2)

As specified in the test plan, the first set of windrows, UWR1 and UWR2, contained a soil fraction of 10% by volume. UWR1 was turned with the KW composter three times per week, while UWR2 was turned daily. For both windrows, temperature, oxygen, moisture, and pH measurements were taken according to the schedule outlined in the Test Plan. The graphs showing the average values of these variables over the life of the windrows are shown in Figures 5-16 and 5-17.

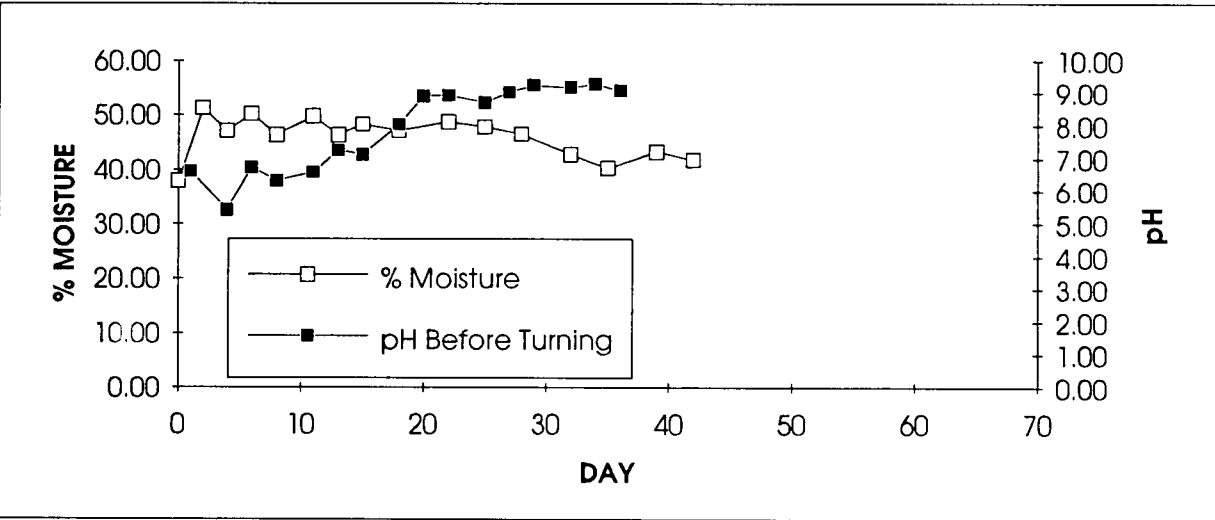
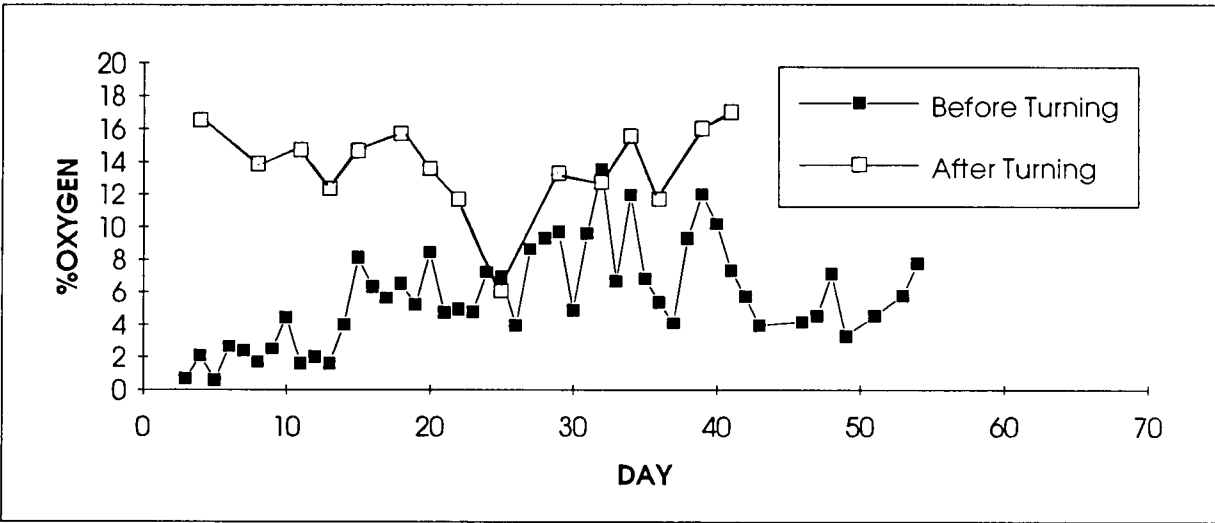
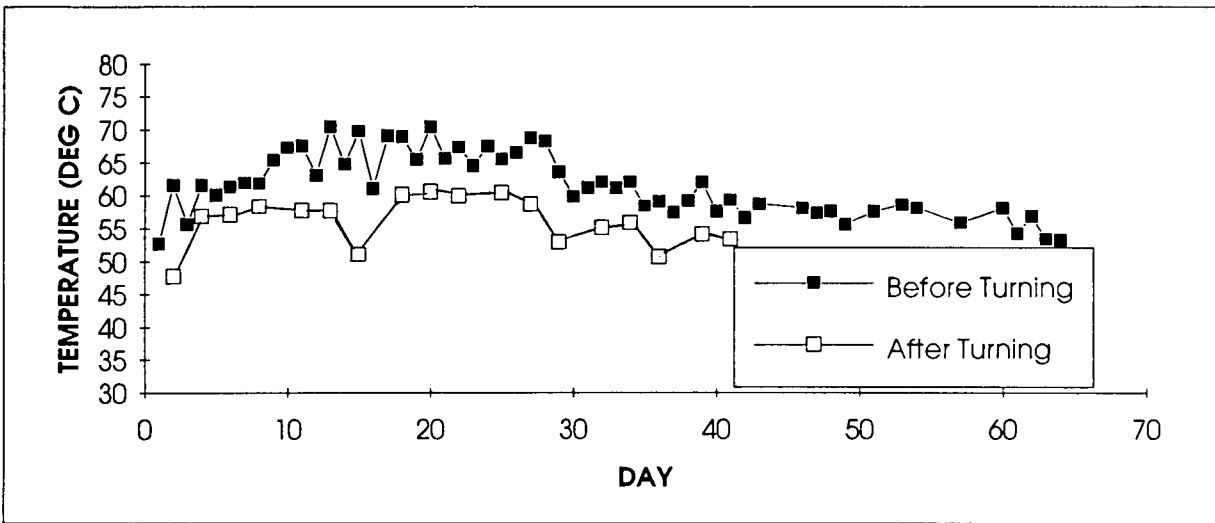

FIGURE 5-16 UNCONTAMINATED, UNAERATED WINDROW (UWR1) WITH 10% SOIL

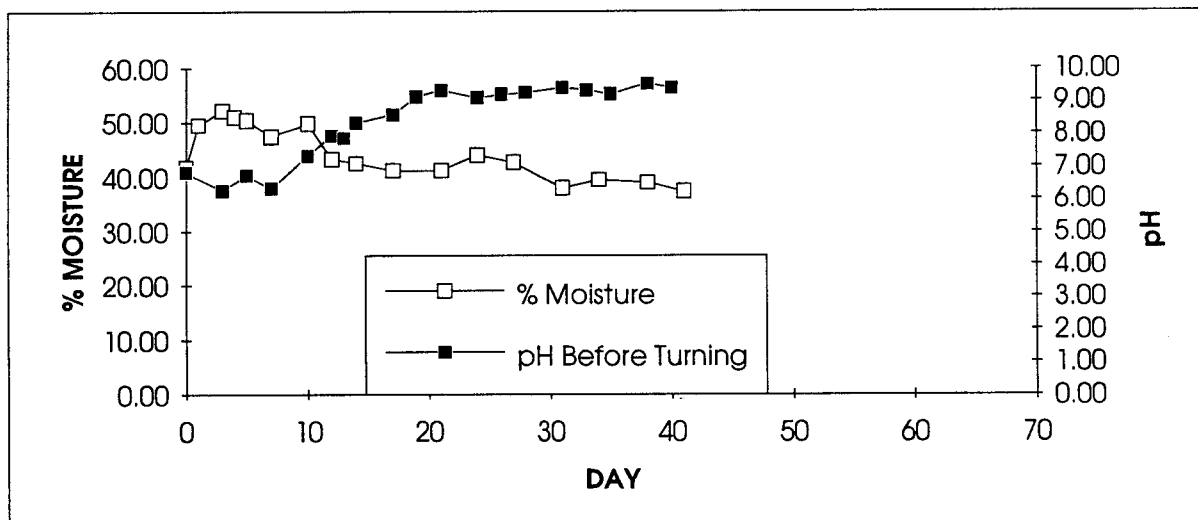
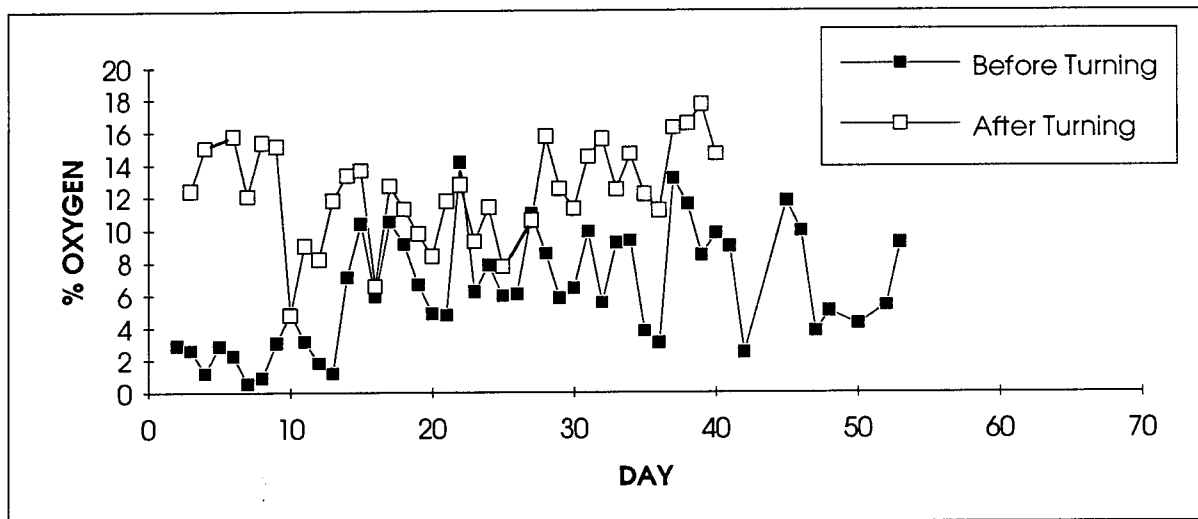
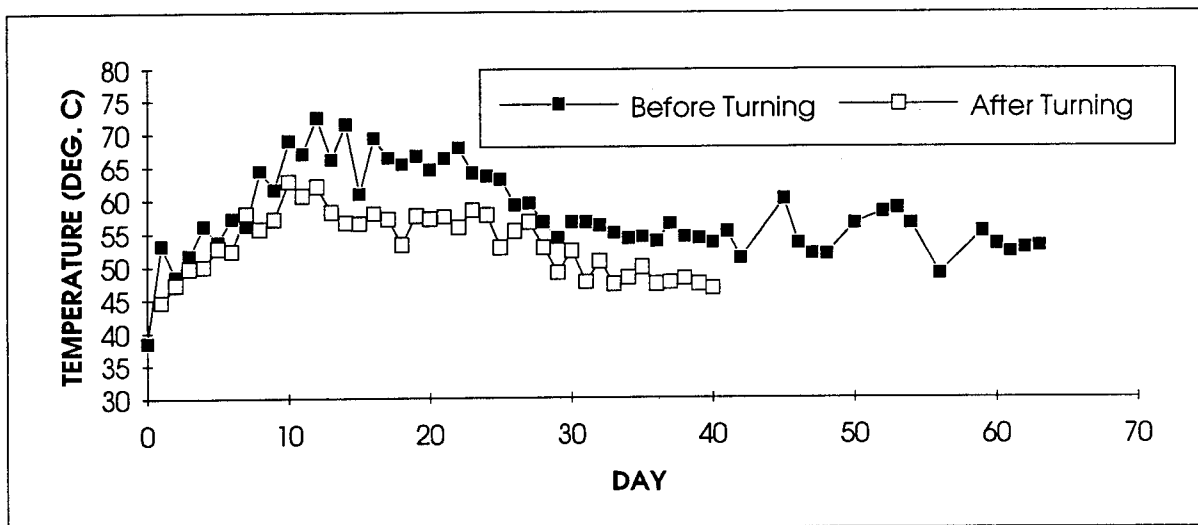

FIGURE 5-17 UNCONTAMINATED, UNAERATED WINDROW (UWR2) WITH 10% SOIL

5.2.1.1 Temperature

In general, the average temperature diagram indicates whether effective thermophilic composting conditions were achieved in the windrow over the duration of its operation. Both windrows UWR1 and UWR2 exhibited steady increases in average temperature from initial temperatures near 40 °C on Day 0, to maximum average temperatures of approximately 70 °C between days 10 and 20. From Day 20 on, temperatures gradually decreased. However, average temperatures did remain above 50 °C through Day 63. The rate of temperature decrease was slightly quicker in UWR2, possibly because of the greater heat loss associated with the daily turning frequency as compared with the less frequent turning of UWR1. The cooling effects of turning varied from day to day; however, the drop in temperature was typically around 7 to 9 °C. Average ambient temperatures increased throughout the duration of this test from temperatures in the 15 to 20 °C range at the beginning of the test, to temperatures in the 20 to 25 °C range by the end of the study.

5.2.1.2 Oxygen

Daily measurements of the interstitial oxygen at various points in UWR1 and UWR2 were made during the operation of these two windrows. Top, middle, and bottom measurements were taken along both the inner and outer planes (see Figure 4-3) both before and immediately after turning the windrows with the windrow turner. The intent of this monitoring was to assess the effects of the two different turning frequencies on the interstitial oxygen levels in the windrows.

As discussed in Appendix C, calibration of the direct oxygen level meters indicated that reliable readings were obtained at oxygen levels down to 1%. Readings below this level are not considered quantitatively reliable.

As shown by the middle graphs in Figures 5-16 and 5-17, average oxygen levels prior to mixing were well below the ambient oxygen level in air of 20.9% by volume. These average levels before mixing ranged from less than 1% to as high as 14%. Variability in oxygen throughout the pile and from day to day was quite high, as indicated by the random appearance of the graphs.

Oxygen measurements taken immediately after turning were higher than those measured before turning, indicating that the windrow turner was providing aeration to the compost. However, this aeration was only temporary, as interstitial oxygen levels fell rapidly following turning. To assess the rate of depletion of interstitial oxygen, an extended oxygen depletion study was conducted in which measurements were made every minute for approximately 1 hour following the turning of UWR2. This test was conducted on two separate occasions, the results of which are presented in Figure 5-18. The data on which this graph is based are presented in Appendix F. From the graph, it is clear that any increase in oxygen caused by turning is not likely to last for more than 1 hour following turning.

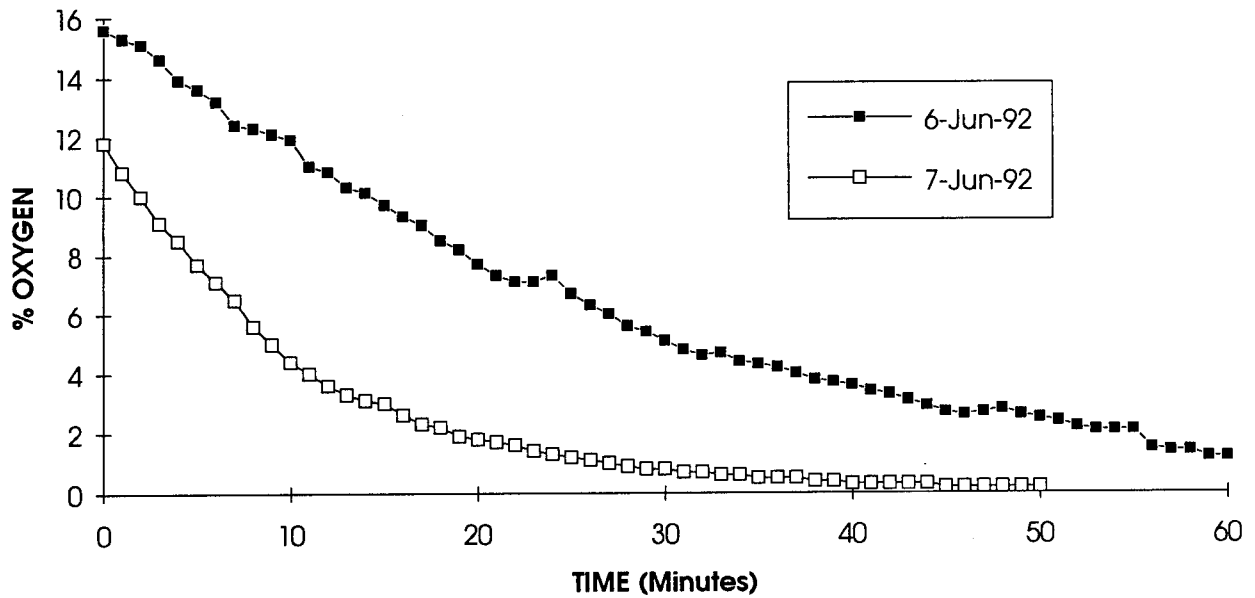

FIGURE 5-18 OXYGEN DEPLETION FOLLOWING TURNING OF UWR2

With respect to overall oxygen supply, it might also be noted that compaction occurred over time in the windrows following turning. This effect would reduce the total volume of interstitial space within the windrow, also reducing the total quantity of available oxygen.

5.2.1.3 pH

As illustrated by the bottom graphs in Figures 5-16 and 5-17, the pH of the compost in UWR1 and UWR2 increased throughout the duration of the study from an initial value near 6.0 to a final value of approximately 9.0 by Day 40. These observed changes were consistent with observations made during the previous field study at UMDA [1].

5.2.1.4 Moisture Content

The percent moisture (wet basis) of the compost in UWR1 and UWR2 showed a slight downward trend as water was lost to evaporation. Periodic additions of water were made manually to UWR1 and UWR2 using a garden hose with a flow rate of 8 gallons per minute. Throughout the study, approximately 2,350 gallons of water were added to each windrow.

5.2.2 UNCONTAMINATED WINDROWS 3 AND 4 (UWR3 AND UWR4)

The monitoring techniques of the first set of windrows (UWR1 and UWR2) were carried over to the next set of windrows (UWR3 and UWR4), which were constructed with 20% uncontaminated soil by volume. The turning frequency variable was maintained with UWR3 being turned three times per week and UWR4 being turned daily. As a result of the low interstitial oxygen levels observed in the initial trials, the amendment recipe was modified to include approximately 10% wood chips in windrows UWR3 and UWR4. The wood chips were intended to provide increased porosity in an effort to increase the natural aeration of the windrows. To ensure that the carefully balanced chemical properties of the compost remained constant, the wood chips were substituted for a portion of the sawdust such that the overall percentage of wood-derived material in the compost was the same. The recipe used for these windrows is presented in Table 4-3. Profiles for average temperature, oxygen, moisture, and pH for UWR3 and UWR4 are presented in Figures 5-19 and 5-20.

5.2.2.1 Temperature

The temperature profiles for these two windrows were quite similar, as indicated in Figures 5-19 and 5-20. The maximum average temperatures achieved in both windrows was approximately 68 °C, slightly less than the 70 °C maximum attained in UWR1 and UWR2. Based upon these temperature data, effective thermophilic composting conditions were achieved in both of these 20% soil (by volume) windrows. The average drop in temperature following turning was again in the range of 7 to 9 °C. Average ambient temperatures typically ranged between 20 °C and 30 °C throughout the study.

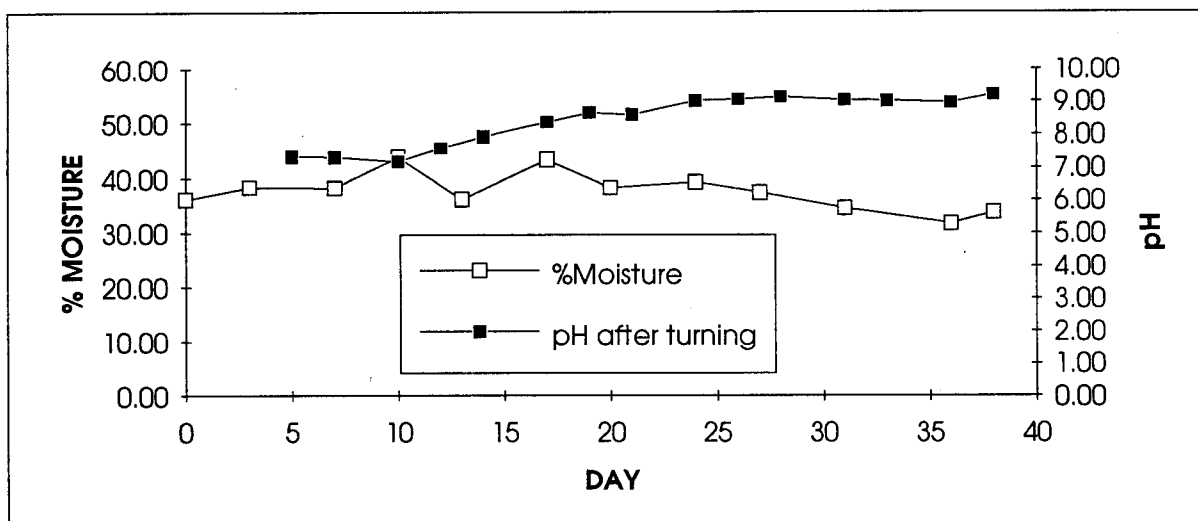
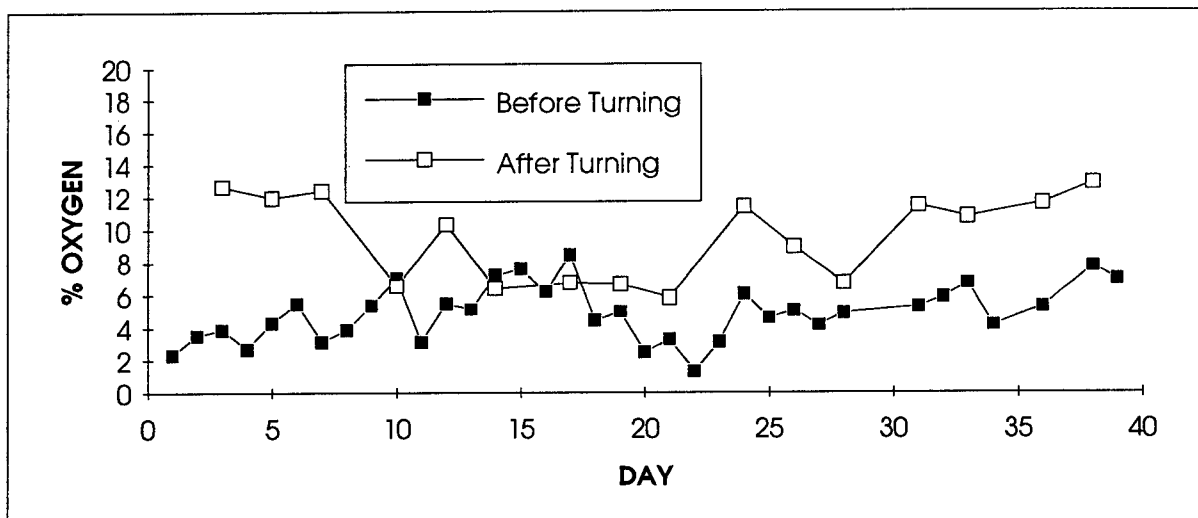
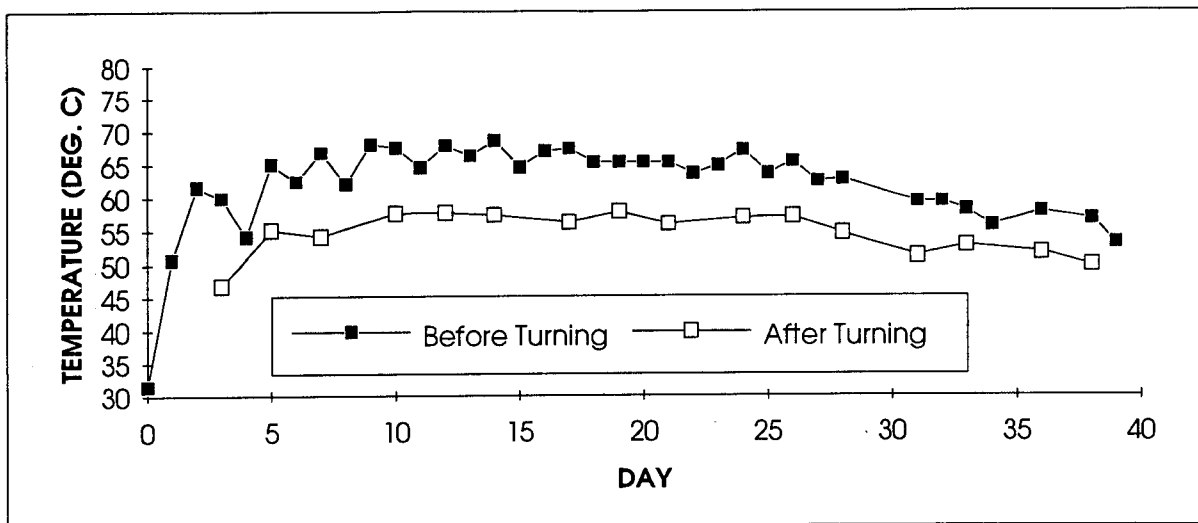

FIGURE 5-19 UNCONTAMINATED, UNAERATED WINDROW (UWR3) WITH 20% SOIL

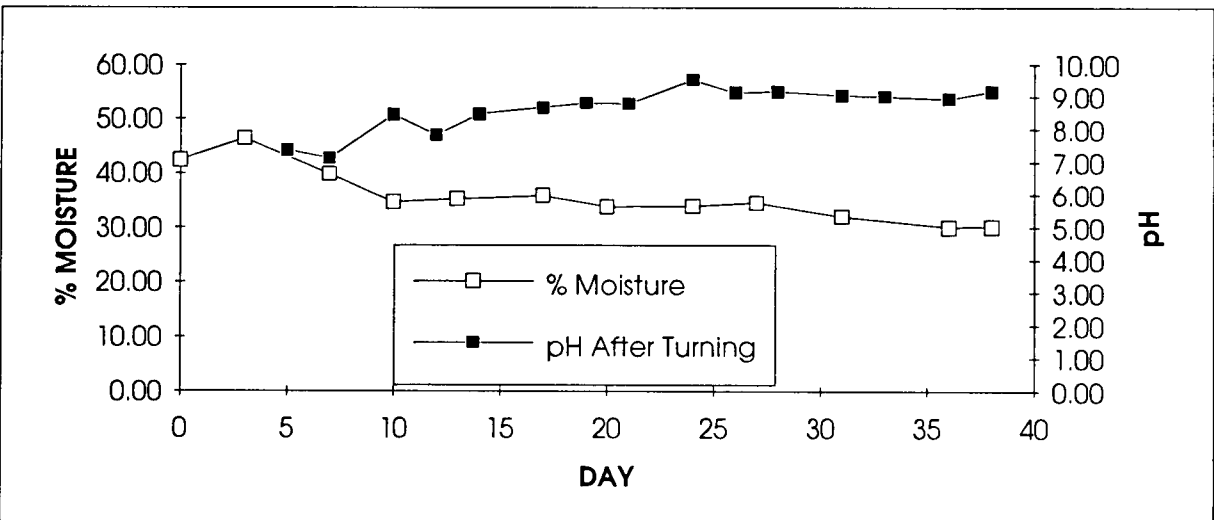
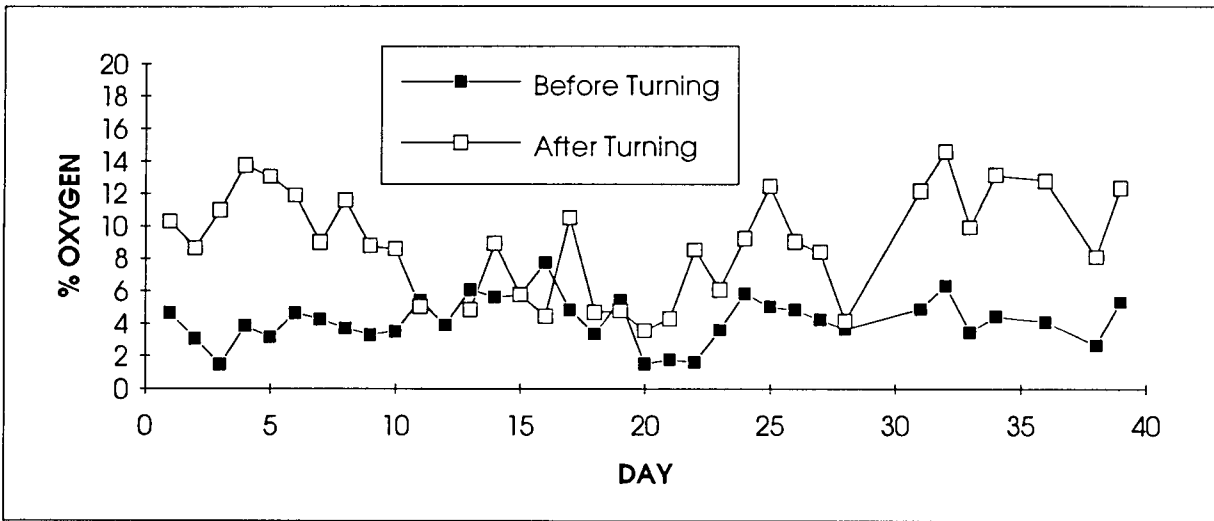
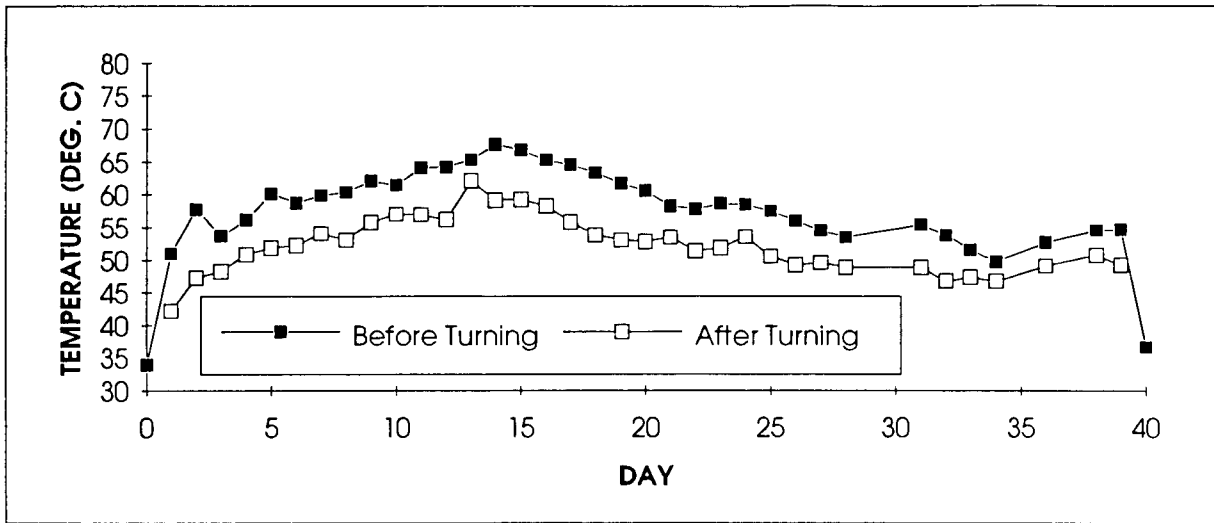

FIGURE 5-20 UNCONTAMINATED, UNAERATED WINDROW (UWR4) WITH 20% SOIL

One observed difference between these two windrows was that UWR3 reached the higher temperatures more quickly than UWR4, and then maintained these temperatures for a longer period than UWR4. Again, this is probably a result of a greater heat loss from UWR4 associated with the daily turning frequency. Overall, however, both windrows were able to maintain thermophilic temperatures throughout the bulk of the 40-day duration of the tests.

5.2.2.2 Windrow Supplementation

Supplementation of windrows was planned to evaluate the ability to re-establish active thermophilic composting conditions by addition of fresh amendment mixture. Windrow UWR4 was supplemented with 5% by volume of the original compost recipe amendments on Day 71 of the study. By this time, the temperature of the pile had dropped to approximately 45 °C, and the objective was to see how quickly the pile could be restarted and how quickly thermophilic conditions could be re-established. Figure 5-21 presents the temperature profile for the 23 days following supplementation.

Within 4 days of supplementation, the average temperatures in the windrow were back up to approximately 60 °C. The windrow then began to cool very gradually over the remaining days of the study. This indicates that the period of active thermophilic composting could be extended, if necessary, by adding supplemental amendments to the windrow after temperatures have dropped into the mesophilic range.

5.2.2.3 Oxygen

As noted previously, based upon the low oxygen values measured in UWR1 and UWR2, the decision was made to substitute wood chips for half of the sawdust called for in the original recipe to provide better bulking and aeration within the piles. As indicated by Figures 5-19 and 5-20, the interstitial oxygen levels in UWR3 and UWR4 were comparable to the levels measured in the first two windrows. Before turning values ranged from less than 1% to 8% oxygen by volume. It is possible that the increased volume of soil in UWR3 and UWR4 (20% by volume) further reduced aeration efficiencies within the piles, resulting in lower oxygen levels. It is also possible that the relatively low fraction of wood chips contributed to the lack of an observable effect from this modification.

5.2.2.4 pH

The pH levels in UWR3 and UWR4 showed an increasing trend throughout the 40-day duration of the test from low values near 7.0 to high values just greater than 9.0. As with previous tests in this program, these observations are consistent with past experience [1].

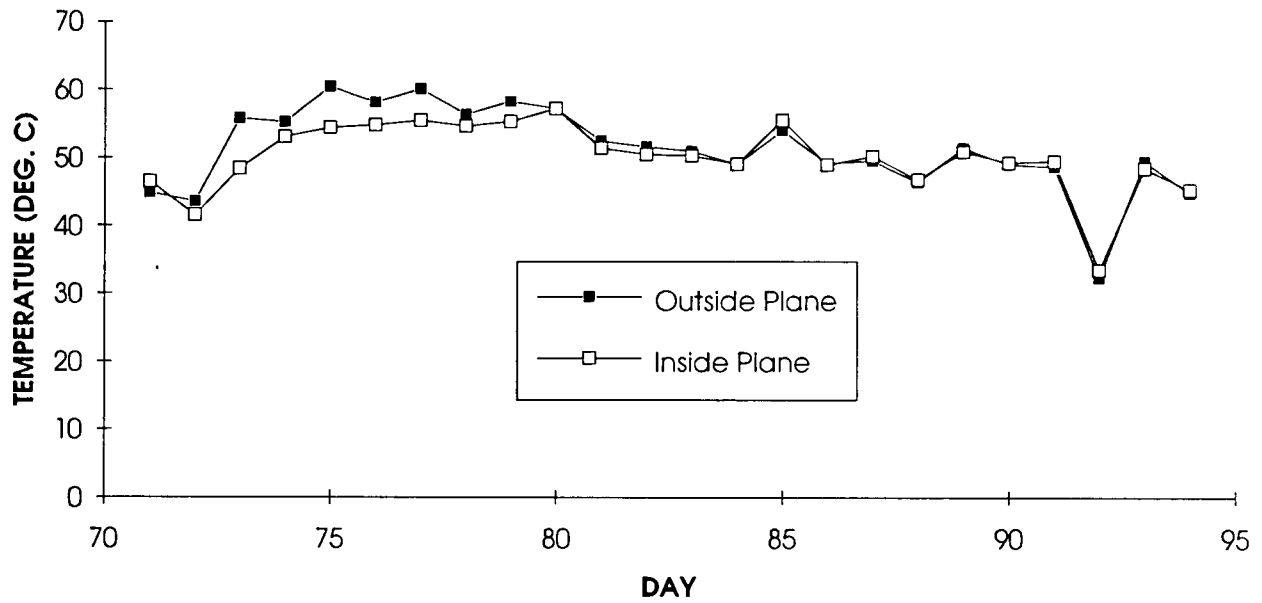

FIGURE 5-21 TEMPERATURES AFTER SUPPLEMENTATION OF UWR4

5.2.2.5 Moisture Content

Moisture content within these windrows was maintained with manual additions of water with the garden hose. The volume of water added during these additions was based upon the results of the semiweekly moisture measurements and upon visual observations of the compost consistency. Throughout the 40-day duration of the study, a total of 2,168 gallons was added to UWR3, and 2,560 gallons were added to UWR4. The profiles for the percent moisture of the windrows is given in Figures 5-19 and 5-20.

In full-scale operations, the source of this added water could be potable water or, possibly, water from other site activities (such as soil/rock washing), if implemented. The quantity and suitability of these sources would require evaluation for their potential effect on the composting process.

5.2.3 UNCONTAMINATED WINDROWS 5 AND 6 (UWR5 AND UWR6)

Operating data from windrows UWR1 through UWR4 indicated that thermophilic composting was achieved in the windrow mode of operation. However, relatively low interstitial oxygen levels were observed. Based upon the interstitial oxygen data obtained in UWR1 through UWR4, the decision was made to evaluate the effectiveness of forced aeration in raising and maintaining the oxygen levels within the windrows. The variable of turning frequency was abandoned in favor of a daily turning frequency for both UWR5 and UWR6. The amendment mixture used for these windrows was based upon the original recipe, without the substitution of wood chips. Both windrows were constructed with 30% soil by volume as specified in the test plan.

Windrow UWR5 was constructed over a bed of wood chips in which were laid two flexible perforated pipes. The pipes were connected to two mechanical blowers, each having a capacity of 405 standard cubic feet per minute (scfm) at a static pressure of 3 inches of water, which were used to provide forced aeration to the windrow. In order to minimize delays in the field program, two spare blowers from the aerated static pile reactor system were employed for this purpose. Because the windrow testing site was remote from the aerated static pile site, a separate blower control panel was designed and fabricated for use in the windrow testing. The control panel incorporated the basic operating strategy employed in the previous aerated static pile testing, with blower operation being driven by temperature readings with adjustable backup timer control. Temperature control was based upon the output signal of four J-type thermocouples which were wired in parallel to provide an averaged value output. The four thermocouples were spaced evenly along the central axial plane of the windrow to provide a signal representative of the entire windrow. Data logging and recording capabilities were not provided by this system. Instead, the temperature data for this windrow were obtained manually during daily operations as was done in the previous windrows.

5.2.3.1 Temperature

Although the main purpose of the windrow aeration system was to provide oxygen to UWR5, the control panel was also used to control the temperature of the windrow to the desired thermophilic range of near 55 °C. Initial operating data indicated that although the aeration system was powerful enough to oxygenate the windrow, it did not have the capacity to prevent initial overheating of the windrow. By Day 3 of the study, the average temperature of UWR5 was 75 °C, despite continuous operation of the blowers. Individual locations within the pile were as high as 80 °C. By Day 5, the average temperature was down to 70° C, and this downward trend continued throughout the duration of the study. On several occasions, the duration of the On Time portion of the blower cycle was adjusted to prevent unnecessary cooling of the windrow. The temperature profile for UWR5 is shown in Figure 5-22.

For windrow UWR6, the heating of the compost was more gradual with a maximum average temperature of near 65 °C occurring between Day 7 and Day 12. Beyond this point, the pile cooled gradually, dropping below 50 °C on about Day 30. For the final 10 days, the turning frequency was reduced in an attempt to maintain temperatures in the pile. As a result, UWR6 was mixed only four times during the last ten days of the study, as indicated by the "after turning temperature" data points in Figure 5-23. Average ambient temperatures decreased throughout this study from near 30 °C on Day 1 to near 20 °C on Day 40.

Based upon these data, thermophilic composting was achieved in both aerated and unaerated windrows at a soil loading of 30% by volume. Early operating data suggests that the stimulatory effect of aeration on heat production outpaced the ability of the available blowers to ventilate the windrows. Preliminary calculations had indicated that the available blower capacity of 405 scfm at a static pressure of 3 inches of water, would prove adequate. To resolve this apparent discrepancy, pressure and velocity measurements were taken in the inlet duct work during operation of these windrows. The results of this test indicated that blower output was less than expected.

Comparison of the temperature profiles also suggests that the supplemental aeration system may result in more rapid, but less prolonged, heating and composting than the nonaerated windrow.

5.2.3.2 Oxygen

As mentioned above, the inclusion of the forced aeration system significantly increased the interstitial oxygen levels within UWR5. The daily before-turning averages for interstitial oxygen were typically near 15%, as shown in the middle graph of Figure 5-22. This contrasts greatly with the unaerated windrow, UWR6, which during the first 20 days of the study had interstitial oxygen levels ranging from less than 1% to 4.0%, the lowest oxygen levels of any windrow study conducted to this point. As previously noted, it is unlikely that readings below 1% oxygen are accurate using the direct-reading oxygen probe (see Appendix C). As a result, readings in the 0% to 1.0% range are expressed as less than 1.0% oxygen.

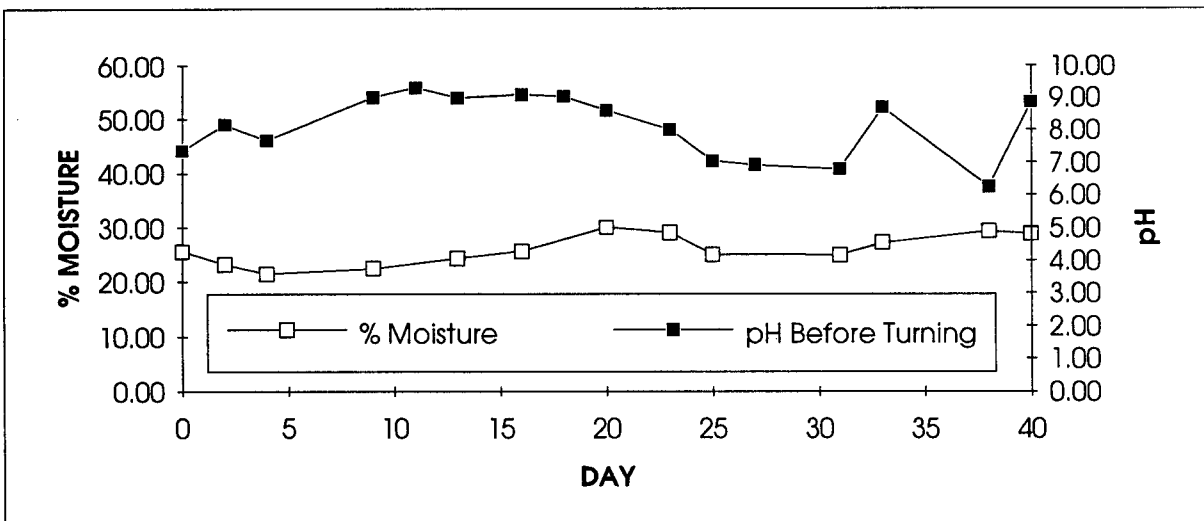
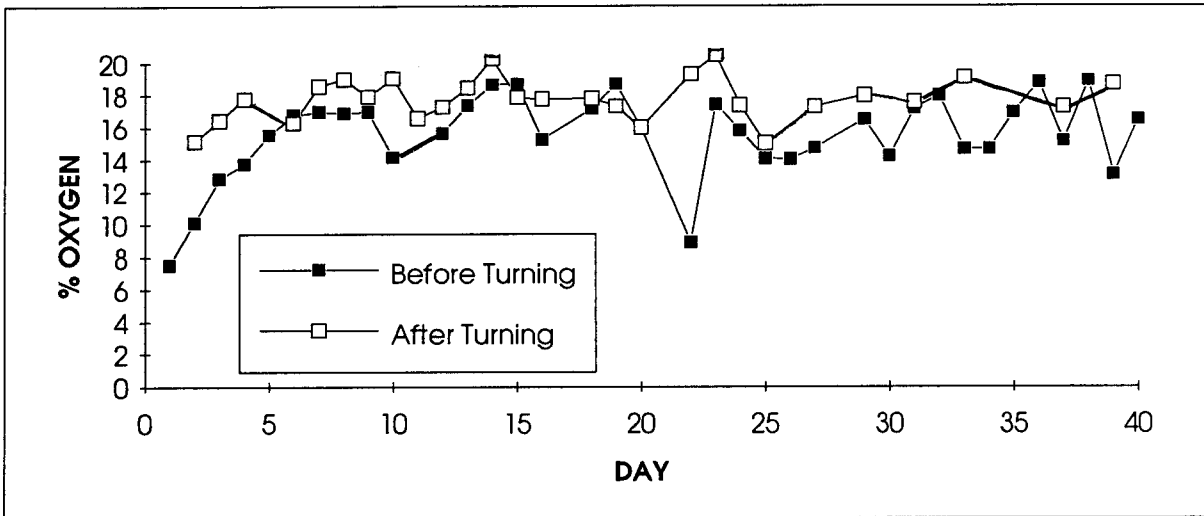
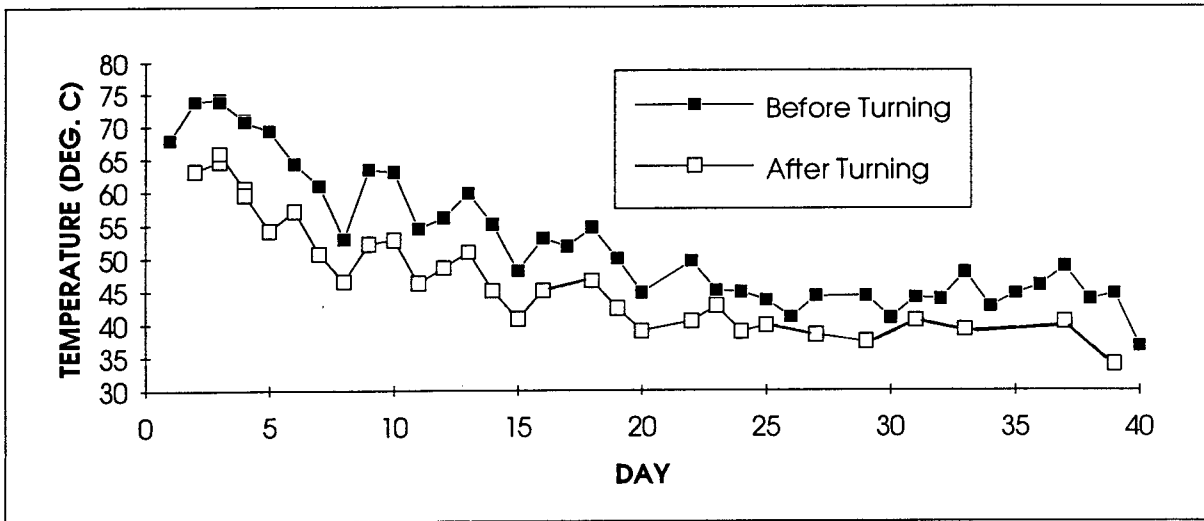

FIGURE 5-22 UNCONTAMINATED, AERATED WINDROW (UWR5) WITH 30% SOIL

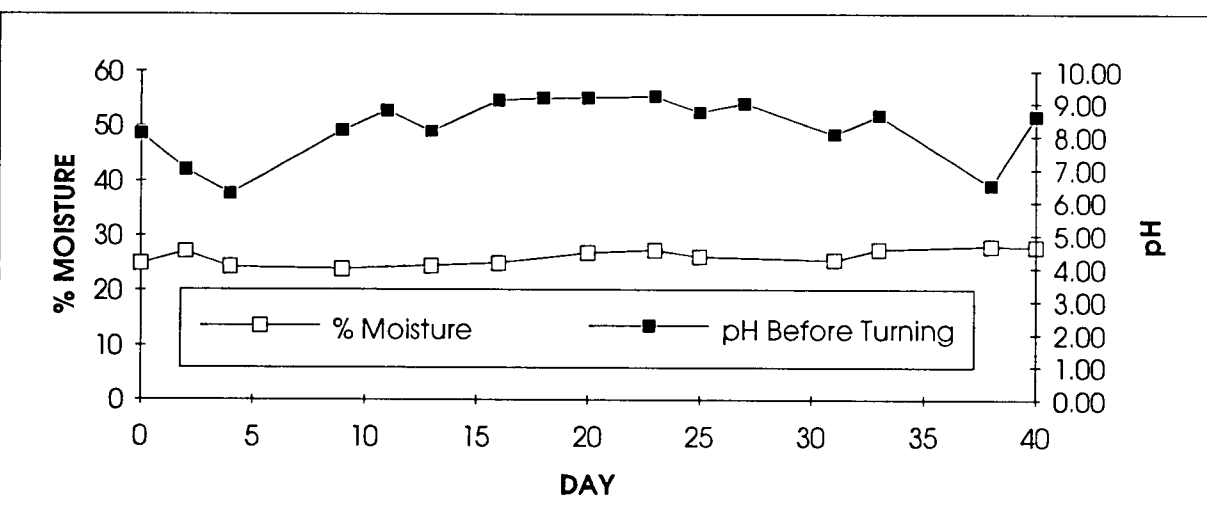
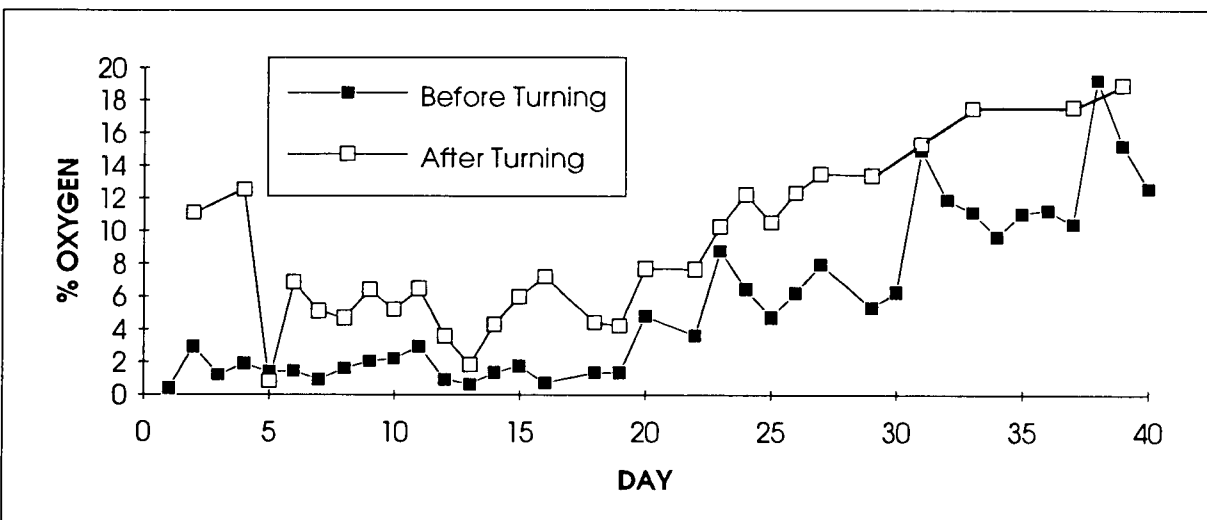
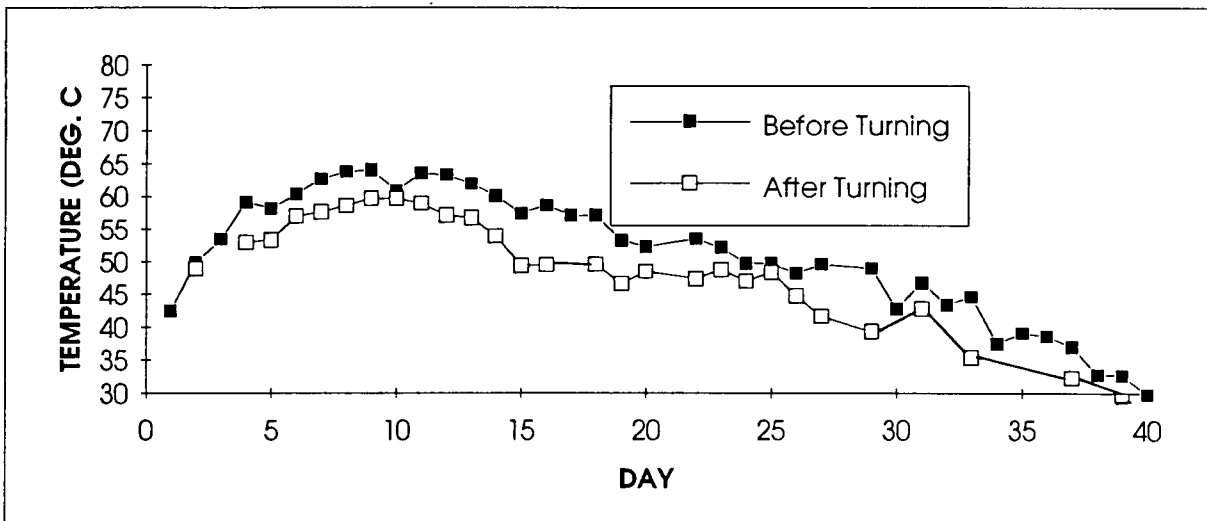

FIGURE 5-23 UNCONTAMINATED, UNAERATED WINDROW (UWR6) WITH 30% SOIL

Beyond Day 20, however, UWR6 began to show signs of increasing interstitial oxygen levels. As indicated in Figure 5-23, this increase in oxygen appears to coincide with the drop in temperature toward the end of the study. Both these trends may indicate that the organic energy sources within the compost were being depleted resulting in less metabolic activity, less heating, and, ultimately, a lower rate of oxygen utilization.

5.2.3.3 pH

The pH levels of UWR5 and UWR6 followed the same trend as the previous four windrows with the exception that after increasing steadily to approximately 9.0, the pH began to drop towards the end of the study. This may indicate that if given enough time to cure, the compost may return to neutral pH values.

5.2.3.4 Moisture Content

UWR5 and UWR6 required the greatest moisture additions of any of the uncontaminated windrows, with UWR5 receiving a total of 3,030 gallons throughout the 40-day duration of the study, and UWR6 receiving only 2,516 gallons. It is likely that the higher water demand in UWR5 was a result of the drying effects of the blowers, particularly during the initial days when the blowers were running continuously. The trends in moisture for the two windrows are shown in Figures 5-22 and 5-23.

5.2.3.5 Microbiology Results

Microbiological and biochemical analyses were conducted beginning with uncontaminated windrows 5 and 6 to assess the microbiological conditions in the windrow system. The majority of these data will be discussed in a separate report. For purposes of this report, key findings based upon microbial population levels will be presented.

Microbiological data for total aerobic and anaerobic microorganisms, obligate anaerobes, and thermophilic bacteria are presented in Table 5-4 for windrows 5 and 6. For these windrows, one composite sample was taken at each time point.

These data show high levels of total aerobic and anaerobic bacteria at the beginning of each windrow, with total population levels declining as the windrow aged. It is important to note that the ratio of aerobes to anaerobes as well as the overall levels of thermophiles were similar in both the aerated and unaerated windrows. Based on these data, the performance of aerated and unaerated windrows was essentially identical in terms of microbial levels.

5.2.4 CONTAMINATED WINDROWS 7 AND 8 (CWR7 AND CWR8)

As specified in the test plan developed for this demonstration, contaminated windrow testing was conducted to evaluate the performance of windrow composting in terms of

Table 5-4

**Bacteria Population Levels in UWR5 and UWR6
(All Values in CFU*/g of Compost)**

Windrow	Day	Total Aerobic Bacteria	Total Anaerobic Bacteria	Total Thermophilic Bacteria	Total Obligate Anaerobic Bacteria
UWR5 (Aerated)	0	10 ⁸	10 ⁸	10 ³	<10 ²
	10	10 ⁴	10 ³	10 ²	<10 ²
	44	10 ³	10 ³	10 ²	10 ²
UWR6 (Unaerated)	0	10 ⁸	10 ⁸	10 ³	10 ³
	10	10 ³	10 ³	10 ²	10 ²
	44	10 ³	10 ³	10 ²	<10 ²

*CFU = Colony-Forming Units

explosives removal, under the best combination of windrow operating conditions determined from uncontaminated windrow testing. The uncontaminated windrow test program indicated, in general, that effective thermophilic composting conditions could be established and maintained in windrows at soil loadings up to 30% by volume. Interstitial oxygen levels in the absence of supplemental mechanical aeration, were typically less than 4% (see Appendix C for discussion of oxygen measurement) during the highly active composting phase, although higher levels were maintained as the windrows aged.

5.2.4.1 Operational Strategy

Previous testing for composting of explosives contaminated soils have employed highly aerobic conditions. While the uncontaminated windrow test program demonstrated that thermophilic composting could be achieved in windrows without mechanical aeration, performance in terms of explosives removal was not known. The contaminated windrow test examined the removal of explosives in aerated and unaerated windrows.

Based upon the results of the uncontaminated windrow test program, contaminated windrow testing was conducted at 30% soil by volume, with daily windrow turning frequency in both windrows. As in the final set of uncontaminated windrows, the variable between the two contaminated windrows was the use of supplemental mechanical aeration in one, with the other relying solely upon windrow turning for operational control.

The basic approach to contaminated windrow testing was analogous to that for uncontaminated windrows UWR5 and UWR6. Additionally, aeration capacity was provided by adding two additional blowers (405 scfm at 3 inches H₂O each) and improving the piping configuration (see Figure 4-5). The blower panel was modified to manage the additional equipment.

5.2.4.2 Analytical Program

As indicated in Subsection 4.13.2, contaminated windrows were sampled and analyzed for explosives on Days 0, 5, 10, 15, 20, and 40. Samples were taken at 14 locations in each windrow. The sample preparation scheme was the same as that used in the seeding study and in the previous UMDA test [1].

In addition to analyses for explosives in compost (TNT, HMX, RDX, 1,3,5-TNB, 2,4-DNT, 2,6-DNT), contaminated windrow samples were also analyzed for selected intermediate explosives metabolites. This testing was conducted to further establish that windrow composting would perform similarly to previous static pile testing in terms of both explosives and their intermediate products. In addition, it was necessary to establish whether performance would vary between aerated and unaerated windrows in terms of explosives and their intermediates. In order to conduct these additional analyses, the available literature on explosives intermediates [11] and analytical methods [9] were re-examined. Based on these sources and on the availability of

USAEC Standard Analytical Reference Materials (SARMs), the following four known TNT intermediate products were selected for analysis:

- 2-amino-4,6-dinitrotoluene
- 4-amino-2,6-dinitrotoluene
- 2,4-diamino-6-nitrotoluene
- 2,6-diamino-4-nitrotoluene

The analytical method used for explosives intermediates employed soxhlet extraction (EPA Method 3540) and gas chromatography with a nitrogen-phosphorus detector (NPD). Method development work included evaluation of the following:

1. Retention time characteristics of the four amino compounds and the other common explosives with a DB-1701 column and an SPB-5 GC column (both columns are 30 m x 0.53 mm).
2. Appropriate calibration levels for the amino compounds required to provide results within the same concentration ranges as USAEC Method LW02.
3. Method performance, as illustrated by the extraction and analysis of multiple reagent blank samples (n=7) spiked with each of the compounds of interest at 5 ug/g.

Retention time data indicated that all four of the amino-nitrotoluene isomers could be separated from each other on both of the GC columns. The peaks for RDX and 2-amino-4,6-dinitrotoluene co-elute on the DB-1701 column, making this a poor choice for these particular samples because of the elevated levels of RDX already identified by the HPLC analysis.

Calibration data for the standard solutions indicated that the instrument response was linear within the concentration range of 0.5 ug/mL to 50 ug/mL, with a correlation coefficient of at least 0.996 for each of the compounds. (A limit of $\pm 20\%$ would be utilized for mid-level continuing calibration standards, analyzed at a frequency of at least one for every 10 sample extracts. If a standard exceeds this limit, appropriate instrument maintenance would be performed. Any extracts analyzed after the out-of-control standard would be reanalyzed.)

Results for the multiple spiked samples, determined on both the analytical columns, yielded average recoveries within the range of 82% to 106%. Method detection limits for the "blank matrix," calculated as $3.143 \times S$ (S = std. deviation of the seven measurements), ranged from 0.695 $\mu\text{g/g}$ to 1.08 $\mu\text{g/g}$.

Three additional "blank" samples were spiked with high levels (100 $\mu\text{g/g}$) of HMX, RDX, and TNT. These samples were extracted and analyzed, and the associated chromatograms were evaluated for degradation products which might interfere with the determination of the A-DNT and DA-NT isomers. The chromatogram did not exhibit

any potential interferences in the retention time region characteristic of the TNT metabolites.

An additional piece of information obtained from the high-level spike study was the fact that HMX did not extract and/or chromatograph very well. This was not apparent during the preliminary low-level spike investigation initially performed for these compounds during the method development, and a late eluting peak which appeared in both the low-level spike and standard chromatograms was erroneously attributed to HMX. When the high-level spike experiment was performed, however, there was no response attributable to the HMX (it would appear that the peak, which was initially related to HMX, was a low-level interference or breakdown product of one of the other explosives).

Because of temporary delays in receipt of SARMs, it was necessary to use non-SARM laboratory stocks of reference materials to avoid violation of sample holding times restrictions.

The analytical laboratory conducted a comparison between the amino-dinitrotoluene (A-DNT) calibration standards and the corresponding SARMs which were received from USAEC on 14 December 1992. The results indicated that the A-DNT standards used were within the laboratory limits of $\pm 15\%$. A similar analysis was not conducted for the diamino-nitrotoluene (DA-NT) standards because the SARMs for these materials were not received.

The data for these intermediate analyses are presented in Appendix F. The differences in lower detection limits between samples are caused by dilution factors and the slight variations in aliquot weights during extraction. J-values and one-half of the lower detection limit presented for U-values were used to calculate average concentrations.

5.2.4.3 Temperature

As observed in the previous uncontaminated windrow study, the aerated windrow (CWR7) reached a higher average temperature in the early period of operation than the unaerated windrow (CWR8). However, these maximum average temperatures were approximately 15 °C lower than the highs in the previous windrows. CWR7 reached a maximum of just over 60 °C. CWR8, however, reached a maximum average temperature of just over 50 °C. Both windrows seemed to heat at approximately the same rate; however, UWR7 began to cool down much more rapidly than UWR8. It is possible that once the organic energy sources were depleted in CWR7, the pile began to cool quickly, and this cooling was further assisted by the periodic aeration cycles. Average ambient temperatures within the containment building decreased from near 15 °C at the beginning of the study to near 5 °C by the end.

The reasons for the lower overall temperatures in these tests as compared to uncontaminated windrows at similar soil loading are not fully known. One likely contributing factor was the lower ambient temperature condition during this test. Also,

the increased aeration capacity in CWR7 may have played a role, as demonstrated by the fact that this windrow did not overheat as did uncontaminated windrow UWR5.

Based on the observed temperature profiles presented in Figures 5-24 and 5-25, thermophilic composting conditions were achieved in both contaminated windrows.

5.2.4.4 Windrow Supplementation

Both piles exhibited a rapid recovery of temperature upon supplementation with 5% by volume of the original amendment mixture on Day 41 similar to the observations for UWR4. As specified in the test plan, this was done to confirm that the active period of composting could be extended if it was determined that more time was necessary to reach explosives reduction goals. Following supplementation, CWR7 reached its previous average high temperature of near 60 °C. CWR8 attained an average before turning temperature of near 40 °C, approximately 10 °C lower than its previous maximum temperature.

5.2.4.5 Oxygen

Oxygen levels within the two windrows again were quite varied from day to day, with the aerated windrow maintaining oxygen roughly in the 10% to 20% range before mixing during periods of high activity, and the unaerated pile maintaining oxygen in the less than 1% range during its active periods. Oxygen levels in both windrows increased toward the end of the 40-day test, and then immediately dropped off following supplementation on Day 41. Of particular note is that oxygen levels in CWR7 were virtually ambient during the period between days 30 and 40. This, combined with the declining temperature profile during this same period, indicates a decline in the rate of biological activity.

The interstitial oxygen profile in the unaerated windrow (CWR8) also shows an increase in oxygen levels as the pile cools, similar to the observed trend in the uncontaminated windrow UWR6. Following supplementation with the additional amendments, interstitial oxygen levels declined in both pile concurrently with the increase in temperature, indicating the resumption of active composting.

One unique feature of the oxygen trends which requires some explanation is the apparent decrease in oxygen in CWR7 after turning. This trend reflects the fact that operational restrictions such as ventilation, visibility, and safety prevented the oxygen measurements from being taken immediately after the turning was performed, as was standard procedure for windrows UWR1 through UWR6. During this interim between mixing and measurement, the forced aeration system was not in operation. As a result, oxygen levels were depleted naturally to some extent before the measurements could be taken.

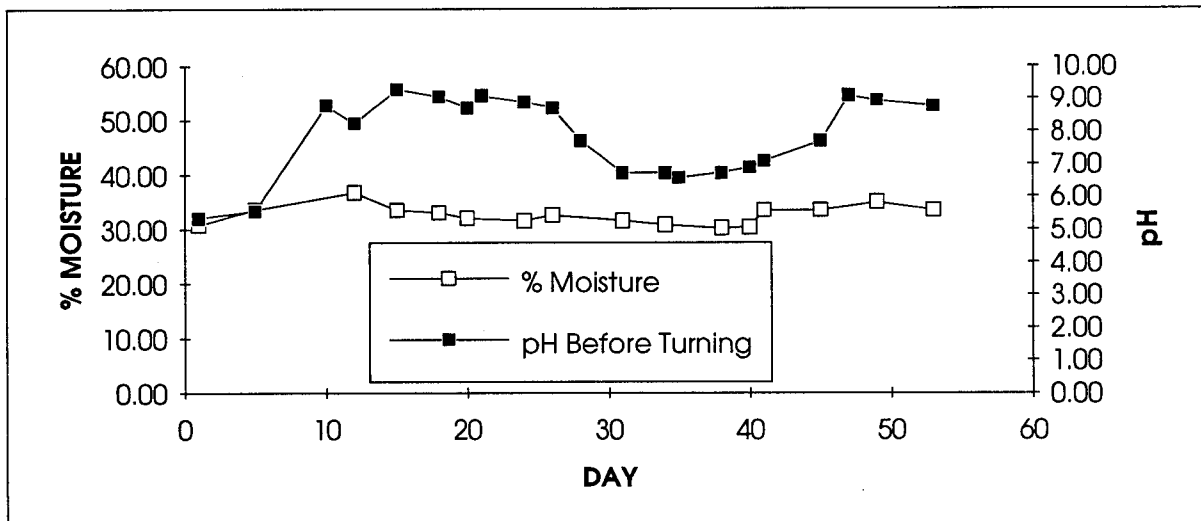
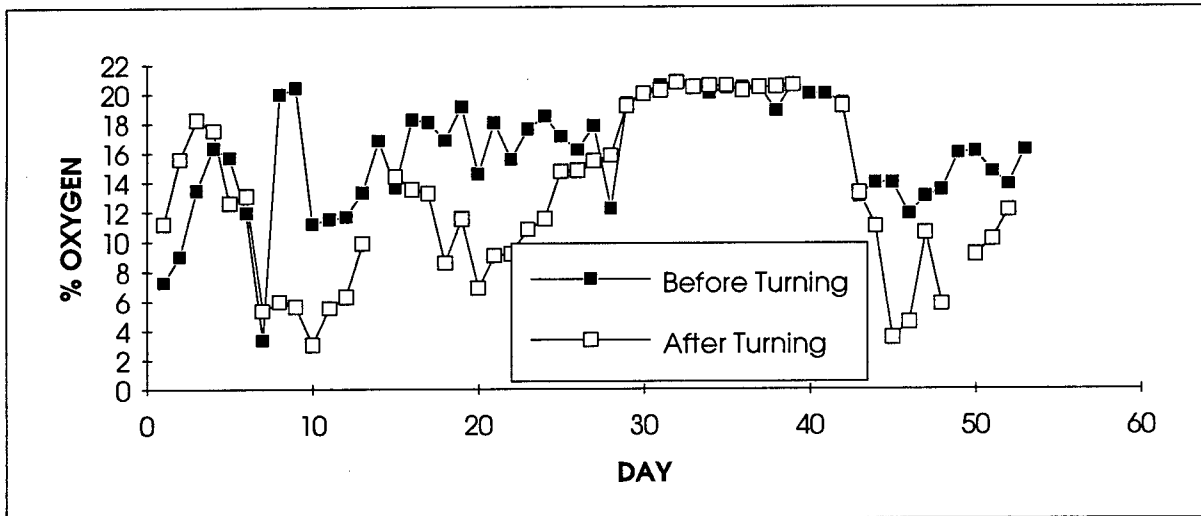
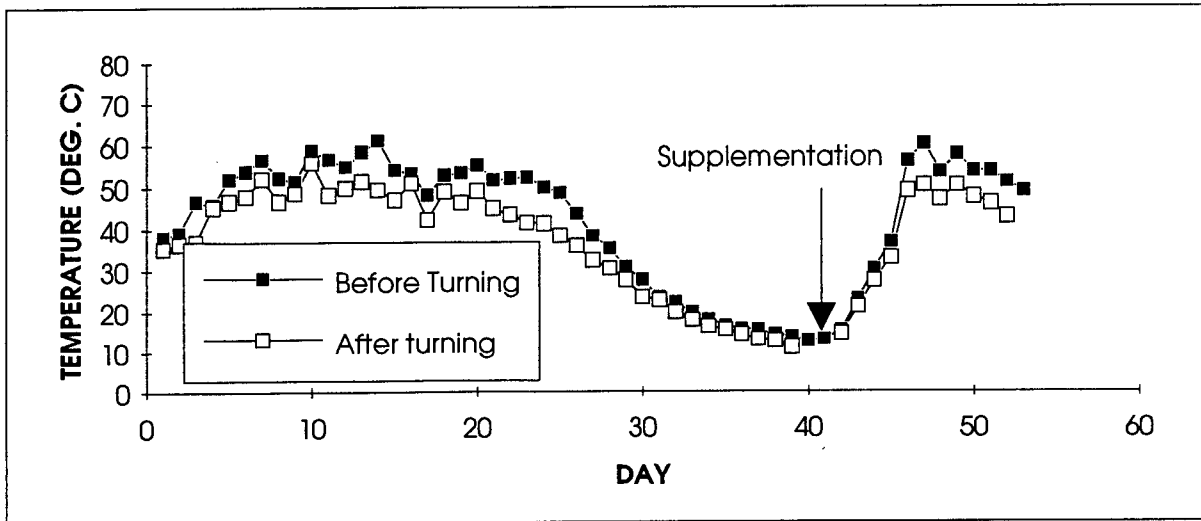

FIGURE 5-24 CONTAMINATED, AERATED WINDROW (CWR7) WITH 30% SOIL

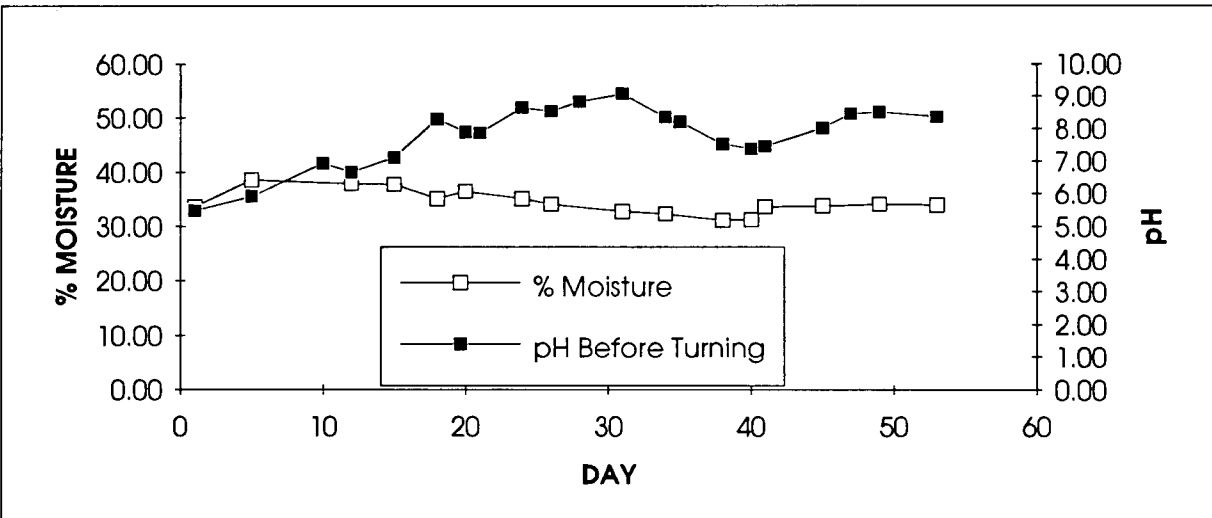
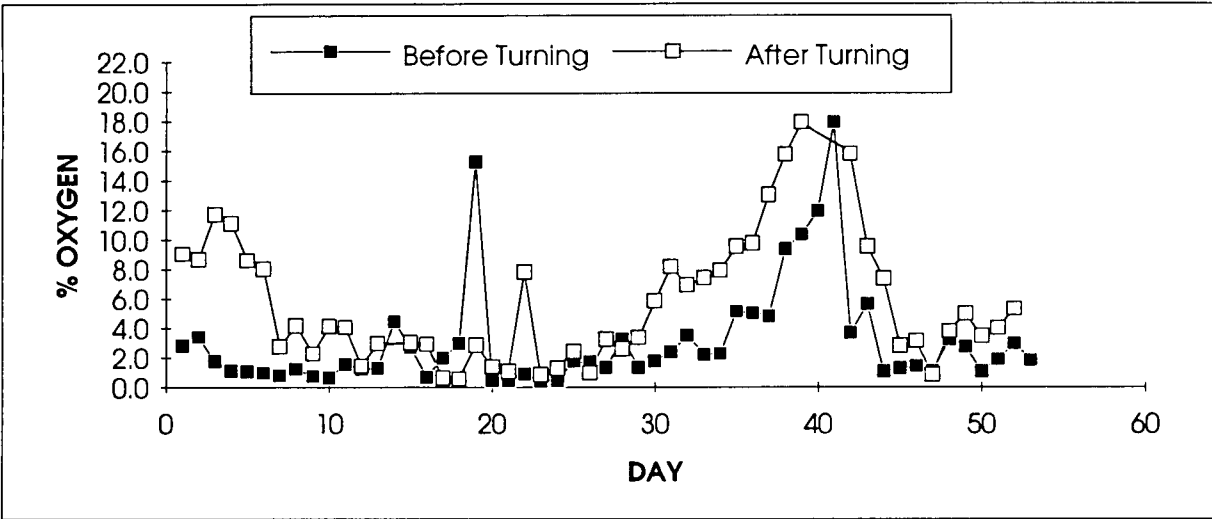
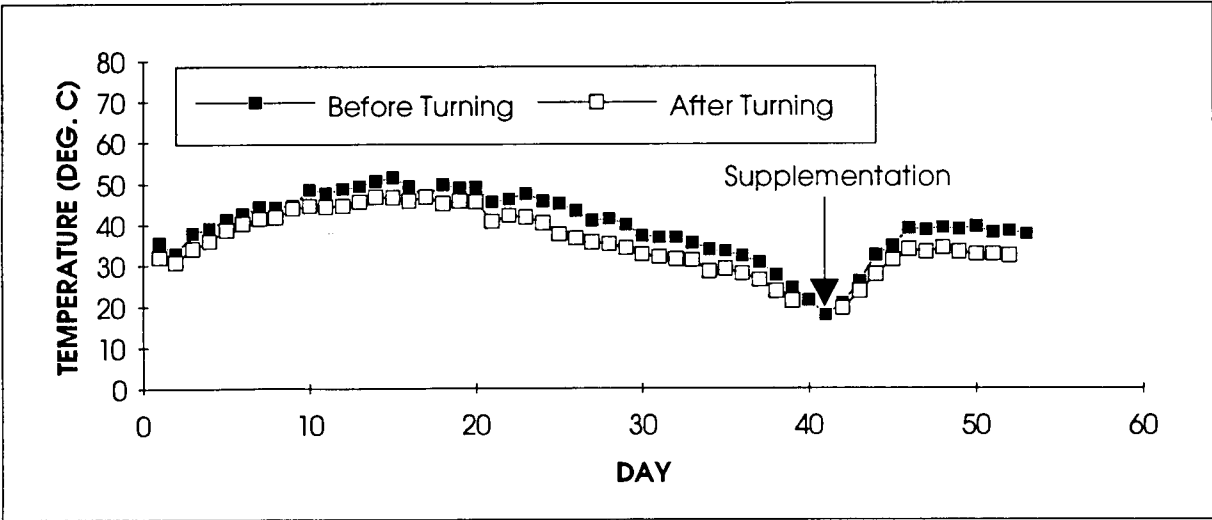

FIGURE 5-25 CONTAMINATED, UNAERATED WINDROW (CWR8) WITH 30% SOIL

5.2.4.6 pH

The pH levels within these two windrows showed the same trend of initial increase followed by a gradual decrease as the activity dropped off during the later days of the study. In addition, the connection between activity and pH was further supported by the fact that pH again began to rise following the supplementation of the piles on Day 41.

5.2.4.7 Moisture Content

Moisture content remained relatively constant over the course of the study despite relatively minimal addition of water to the windrows. Unlike previous windrow tests which required significant water addition to maintain moisture, CWR7 and CWR8 required totals of only 1,483 and 1,063 gallons of water respectively over the first 40 days of operation. The difference between the two is likely as a result of the increased drying caused by the aeration of CWR7. Perhaps the lower overall demand for water for these two windrows was a result of the sheltering of the windrows from the wind and sun. It is also possible that the high humidity within the construction shelter reduced the evaporation rate. Also, the lower ambient temperatures may have further limited the losses because of evaporation.

5.2.4.8 Microbiology Results

Microbiological data from contaminated windrows 7 and 8 are shown in Table 5-5. As with the uncontaminated windrows, both of these windrows contained high initial microbial levels. Each windrow exhibited a moderate decline in overall population levels at the end of active composting but total microbial levels remained high throughout the 40-day test period.

Comparison of data for windrows 7 and 8 also indicates that, as with the uncontaminated windrows, total microbial levels, thermophilic microbial levels, and the relative predominance of aerobes and anaerobes were essentially the same in aerated and unaerated windrows. Based upon these data, the aerated and unaerated windrows were equivalent in terms of microbiological criteria.

5.2.4.9 Explosives Removal

Based upon conventional composting operating parameters, both aerated and unaerated contaminated windrows achieved and maintained effective thermophilic composting for extended time periods. Having established that this was the case, the most significant results for CWR7 and CWR8 were for the explosives removals. Table 5-6 summarizes the average explosives concentrations for the two contaminated windrows. These data have been presented graphically in several ways. Figure 5-26 presents the average explosives concentrations with time for the two windrows to show the general rate of degradation.

Table 5-5

**Bacteria Population Levels in CWR7 and CWR8
(All Values in CFU*/g of Compost)**

Windrow	Day	Position	Total Aerobic Bacteria	Total Anaerobic Bacteria	Total Thermophilic Bacteria	Total Obligate Anaerobic Bacteria
CWR7 (Aerated)	0	Top	10 ⁹	10 ⁹	10 ²	10 ²
		Middle	10 ⁹	10 ⁹	10 ²	10 ²
		Bottom	10 ⁹	10 ⁹	10 ²	10 ²
	40	Top	10 ⁶	10 ⁶	10 ⁷	10 ³
		Middle	10 ⁶	10 ⁷	10 ⁶	10 ³
		Bottom	10 ⁶	10 ⁷	10 ⁷	10 ³
CWR8 (Nonaerated)	0	Top	10 ⁹	10 ⁸	10 ²	10 ³
		Middle	10 ⁵	10 ⁶	10 ²	10 ³
		Bottom	10 ⁷	10 ⁷	10 ²	10 ³
	40	Top	10 ⁶	10 ⁶	10 ⁷	10 ²
		Middle	10 ⁶	10 ⁷	10 ⁷	10 ²
		Bottom	10 ⁶	10 ⁶	10 ⁷	10 ³

*CFU = Colony-forming units

Table 5-6
Average¹ Explosives Concentrations for Contaminated Windrows

Test	Day	2,4,6-TNT (ug/g)	RDX (ug/g)	HMX (ug/g)	1,3,5-TNB (ug/g)	2,6 DNT (ug/g)	2,4-DNT (ug/g)
CWR7	0	1,869	1,069	175	7.27	1.63	2.67
CWR7	5	719	937	126	2.11	0.56	1.64
CWR7	10	20	406	114	2.12	0.40	0.43
CWR7	15	11	65	96	2.09	0.40	0.42
CWR7	20	9	11	58	2.04	0.39	0.41
CWR7	40	4	8	47	2.04	0.39	0.41
CWR7	41	5	7	43	2.10	0.40	0.42
CWR7	53	3	1	7	2.07	0.40	0.42
CWR8	0	1,574	944	159	8.88	1.61	2.48
CWR8	5	101	1,124	158	2.11	0.39	0.66
CWR8	10	26	710	120	2.14	0.41	0.43
CWR8	15	16	75	100	2.05	0.39	0.41
CWR8	20	10	5	1	2.04	0.39	0.41
CWR8	40	4	2	5	2.07	0.40	0.42
CWR8	41	11	2	2	2.10	0.40	0.42
CWR8	53	14	5	1	2.09	0.40	0.42

¹Calculation of averages included actual values present below detection limits (J values) and one-half of lower detection limit for non-detected (U values).

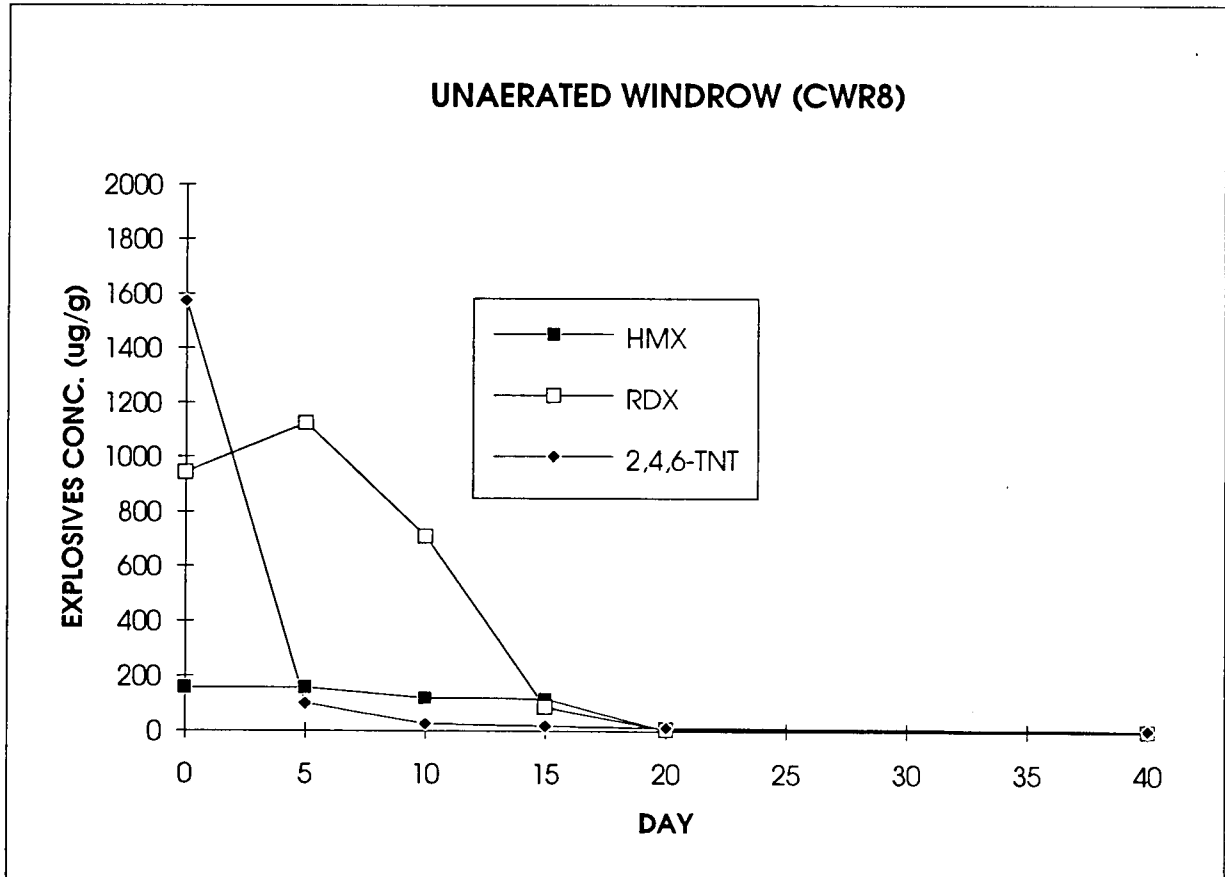
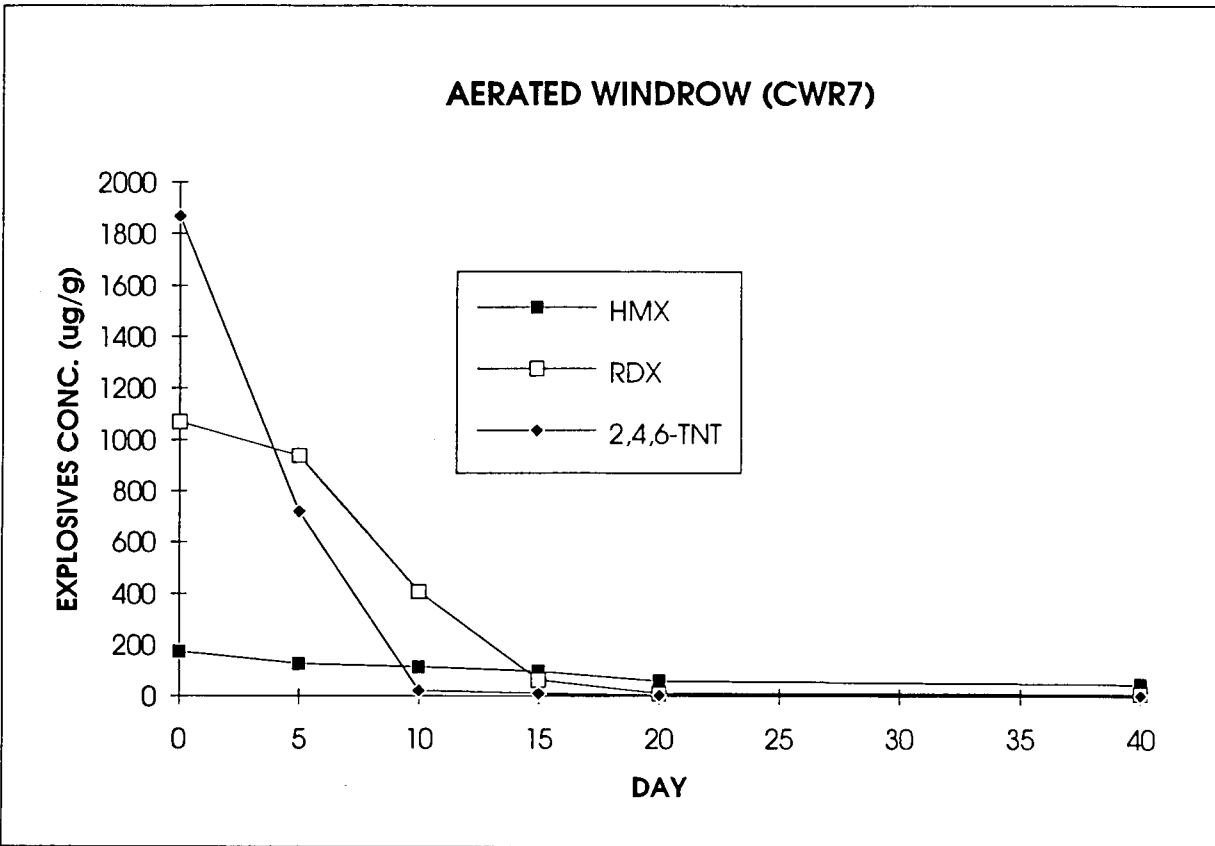

FIGURE 5-26 EXPLOSIVES CONCENTRATIONS VS. TIME FOR WINDROW STUDY

Figure 5-27 presents these same data on a semi-logarithmic scale to allow better comparison between the different explosives. Figure 5-28, presents the percent removal of each of the explosives with time. In this way, variations in starting concentrations have been normalized to enable comparison of reduction rates for each type of explosive. These data are also summarized in Table 5-7.

In the aerated pile (CWR7), the overall removal efficiencies for HMX, RDX, and TNT were 76.6%, 99.2%, and 99.8% respectively after 40 days. For the unaerated windrow (CWR8), HMX, RDX, and TNT reductions were 96.8%, 99.8, and 99.7 respectively after 40 days. The TNT removal appears to have commenced upon initiation of the windrows, while a delay or lag was observed for HMX and RDX. In both windrows, the maximum removals were achieved on or about Day 20. The initial rate of TNT removal and the overall extent of HMX removal were higher in the unaerated windrow than in the aerated windrow.

5.2.4.10 Explosives Intermediate Products

Numerous studies have been conducted to determine the biological transformation products of explosives and nitroaromatics [5]. In particular, much of the focus has been directed to the degradation of TNT. This may result, in part, from the prevalence of TNT in explosives operations. In addition, this focus may reflect the existing understanding of TNT biotransformation which indicates that cleavage of the aromatic ring is not generally achieved. Although the results have varied from study to study, there appears to be consistent evidence that TNT is not completely mineralized to carbon dioxide. Several studies incorporated the use of carbon-14 labeled TNT to track the degradation of the compound. In these studies, small fractions of the original amounts of carbon-14 were recovered in the form of carbon dioxide. The general consensus is that the aromatic ring of the toluene molecule remains resistant to cleavage during the biological transformation of TNT. As a result, the major intermediate breakdown products in the transformation of TNT are amino-dinitrotoluenes and diamino-nitrotoluenes.

Previous field studies and associated testing [5, 1, 9] indicate that known explosives intermediates were removed during the compost cycle. However, all previous tests have employed highly aerobic compost conditions. Therefore, analyses for selected explosives intermediates were conducted for the contaminated windrow tests to determine whether this mode of operation would provide removal of these explosives intermediates.

Analysis of the compost samples taken in CWR7 and CWR8 were performed. These samples were taken on days 0, 5, 10, 15, 20, and 40 and analyzed for the following explosives intermediates:

- 2-amino-4,6-dinitrotoluene (2A-4,6DNT).
- 4-amino-2,6-dinitrotoluene (4A-2,6DNT).
- 2,4-diamino-6-nitrotoluene (2,4D-6NT).
- 2,6-diamino-4-nitrotoluene (2,6D-4NT).

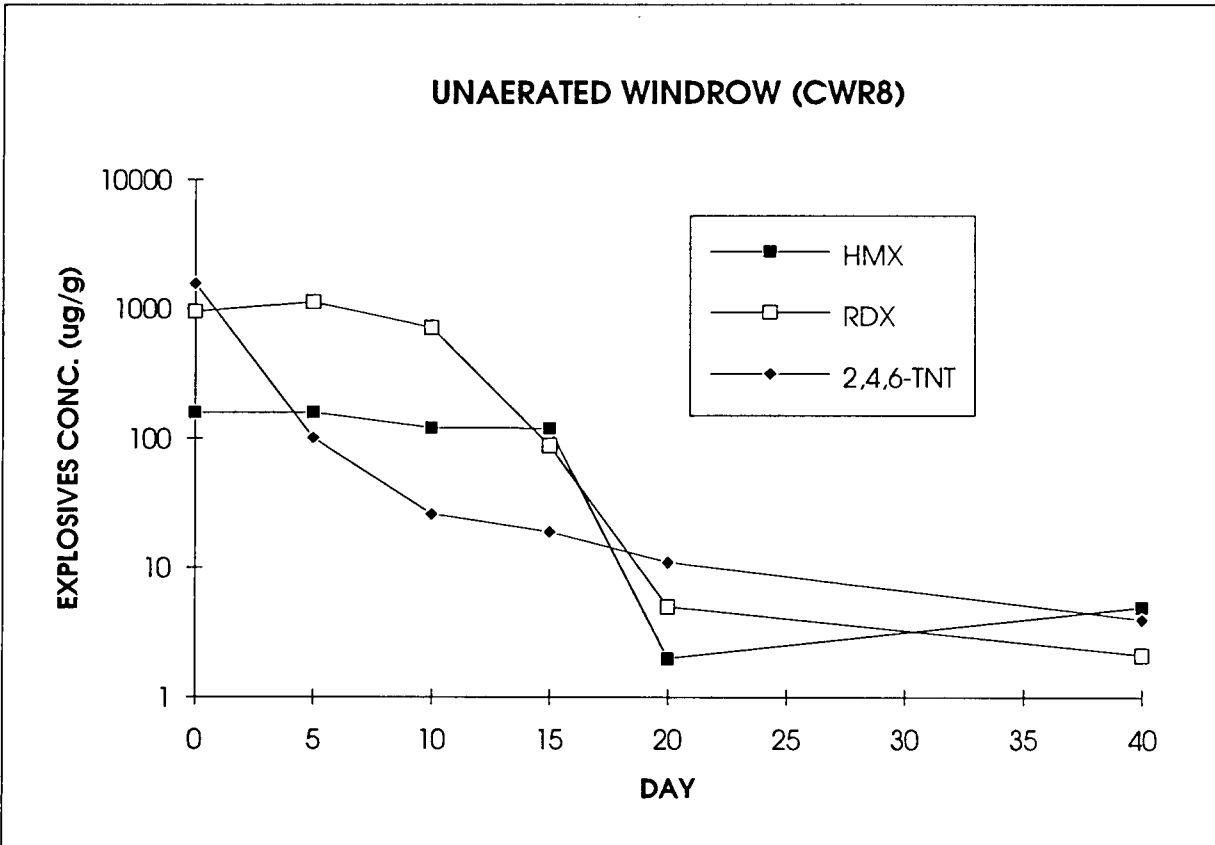
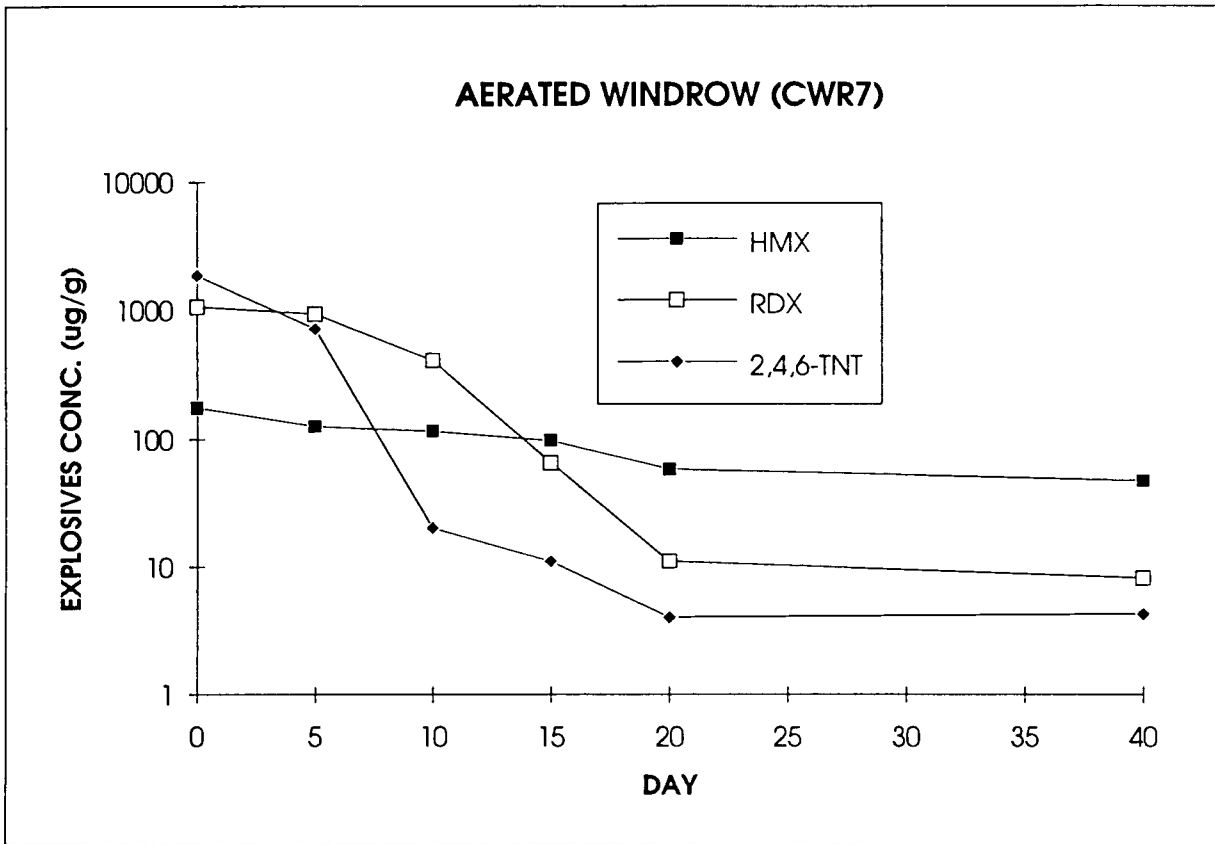

FIGURE 5-27 EXPLOSIVES CONCENTRATIONS VS. TIME (SEMI-LOG SCALE)

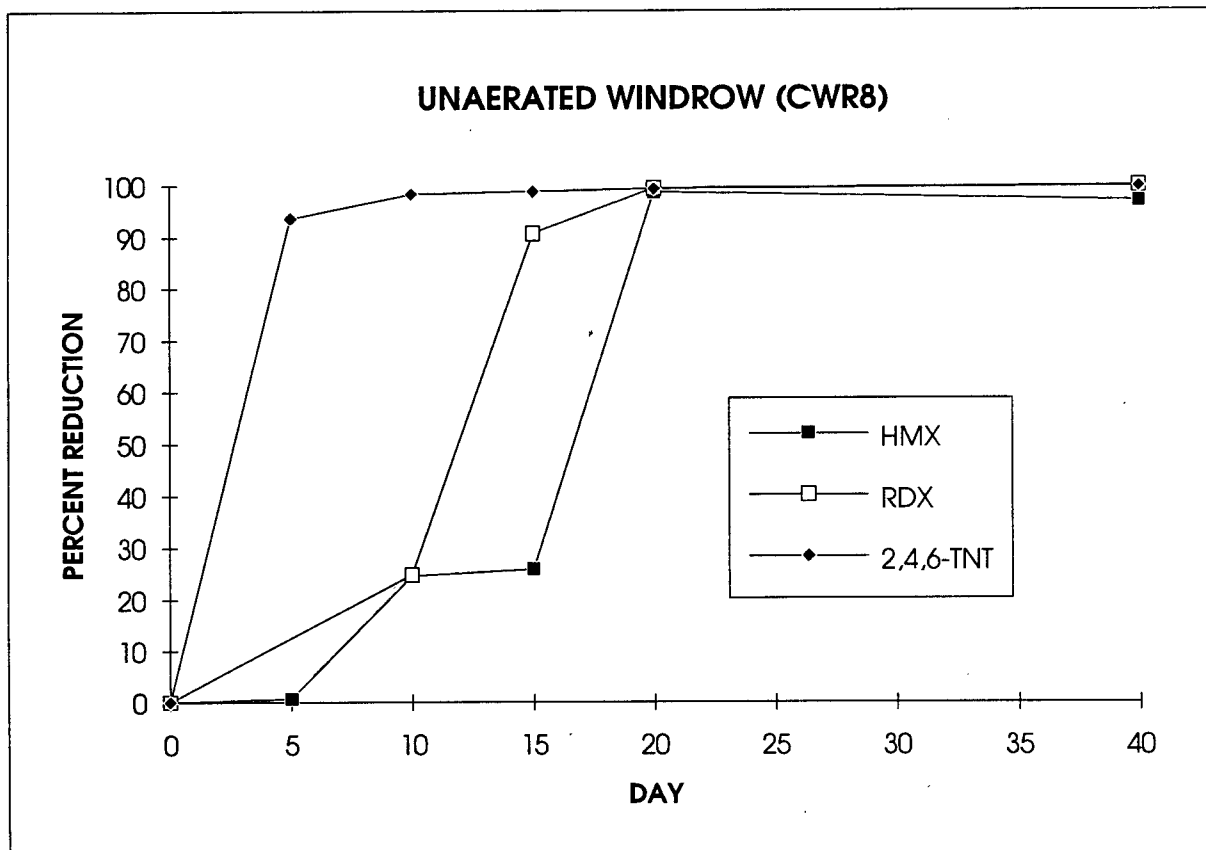
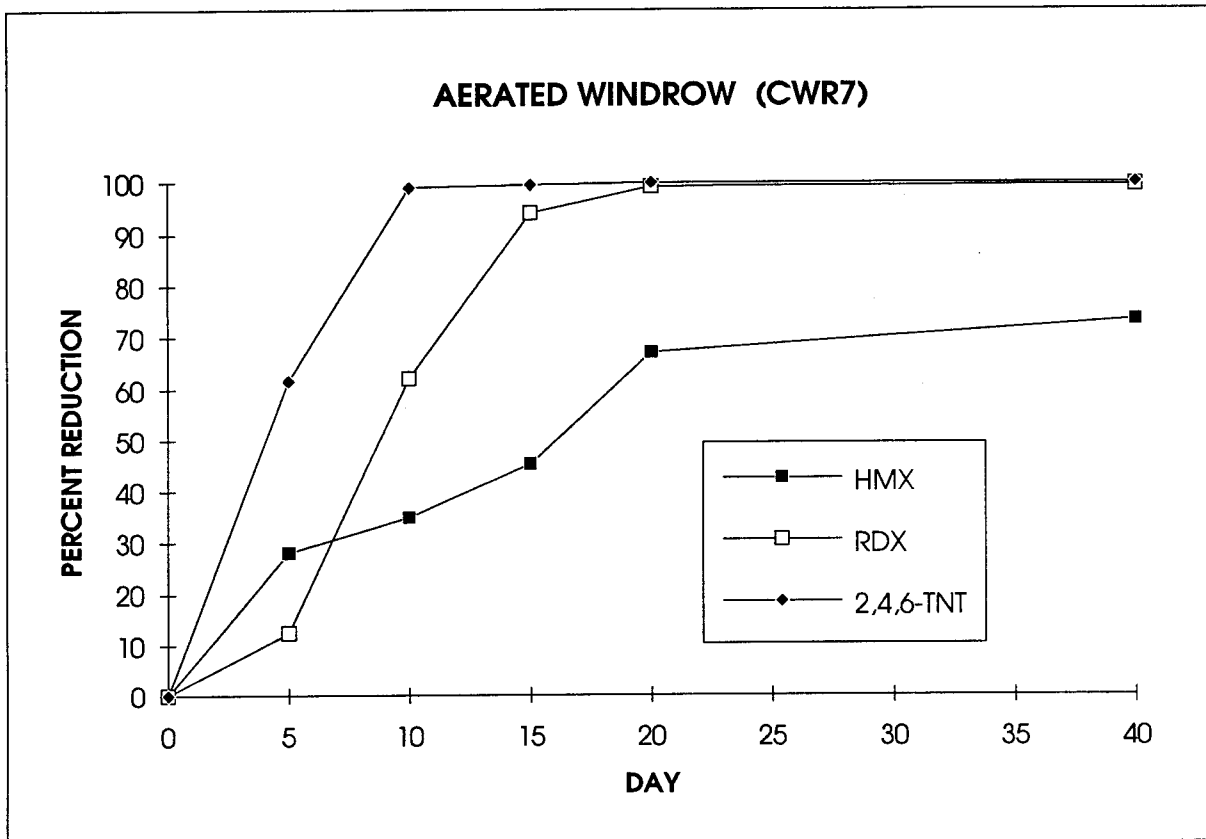

FIGURE 5-28 PERCENT REDUCTION OF EXPLOSIVES IN WINDROW STUDY

Table 5-7

**Windrow Study 40-Day Explosives Removal and
TNT Reaction Kinetics Summary**

Test	Primary Explosives (% Removal)			Regression Results (TNT)	
	TNT	RDX	HMX	K-Value (days ⁻¹)	R-Squared
CWR7 (Aerated)	99.8	99.2	76.6	-0.151	0.638
CWR8 (Unaerated)	99.7	99.8	96.8	-0.126	0.724

Table 5-8 gives the results of the analyses. The values presented are the averages of the 14 samples for each sampling interval for each pile. Care must be taken in evaluating these results, because in some cases, the analytes were not detected in the samples and values used in the calculation of the averages were taken as one-half of the lower detection limit. These detection limits varied from sample to sample because of slight differences in aliquot weights used in the analyses. Also, the dilution factors which were necessary for some of the samples resulted in elevated lower detection limits for these samples. As a result, some of the average values are subjective. Although the averaging method may overestimate the initial concentrations of the intermediates in the compost, the data clearly indicate that these compounds disappear by the end of the study. Appendix F presents all the individual analysis results and can be consulted to determine which averages are affected by the detection limits.

In addition to Table 5-8, the intermediates results have also been presented graphically in Figures 5-29 through 5-34. For both windrows, the intermediates concentrations versus time have been presented on both linear and semi-logarithmic plots. Also, an additional linear plot with intermediates plotted along with TNT concentrations has been included.

From the plots it is evident that in comparison to the TNT levels, the intermediates are much less concentrated in the compost samples. The data suggest that some intermediates were detected in initial (Day 0 samples). Whether this reflects low level biotransformation in the soils prior to initiating the test or residual biological activity during the sample preparation process is not currently known. In general, the samples required about 3 to 5 days to dry during the summer months and up to 7 to 10 days during colder periods. It is not known whether significant biotransformation occurred during this drying period, however, it might be noted that explosives intermediates were detected in initial compost samples in the Louisiana Army Ammunition Plant test [5], for which the present sample drying/milling procedure was not used.

These data demonstrate that the explosives intermediates are removed during the windrow compost process. Nearly complete removal of the four intermediates was observed in both aerated and unaerated windrows. While there were slight differences observed between the aerated and unaerated systems, it appears that the overall performance of each system was essentially the same with respect to these parameters. These results generally indicate that further transformations occur in the compost and that another compound serves as the ultimate end product of the biological transformation of TNT. While these data do not confirm this mechanism, this observation is consistent with previous investigations.

More significantly, these data indicate that 1) windrow composting provides removal of not only target explosives but also of known explosives intermediates, and 2) aerated and unaerated windrows perform similarly with respect to these parameters.

Table 5-8

**Summary of Intermediates Data for Windrow Study
(all values in $\mu\text{g/g}$)**

Windrow	Day	2,4D-6NT	4A-2,6DNT	2,6D-4NT	2A-4,6DNT
CWR7 (Aerated)	0	40.09	238.89	42.44	120.83
	5	12.89	48.14	12.89	68.00
	10	7.99	99.29	11.80	17.67
	15	2.35	30.43	2.31	2.71
	20	1.83	7.73	2.45	1.59
	40	2.54	4.81	2.54	2.11
	CWR8 (Unaerated)	0	34.61	219.11	37.92
5		13.88	90.39	13.84	71.56
10		27.69	130.93	25.70	19.04
15		2.47	6.61	2.28	1.36
20		2.49	2.21	2.65	1.81
40		2.58	3.76	2.58	2.58

Note: For calculation of average concentrations, J-values and one-half of the lower detection limit presented for U-values have been used.

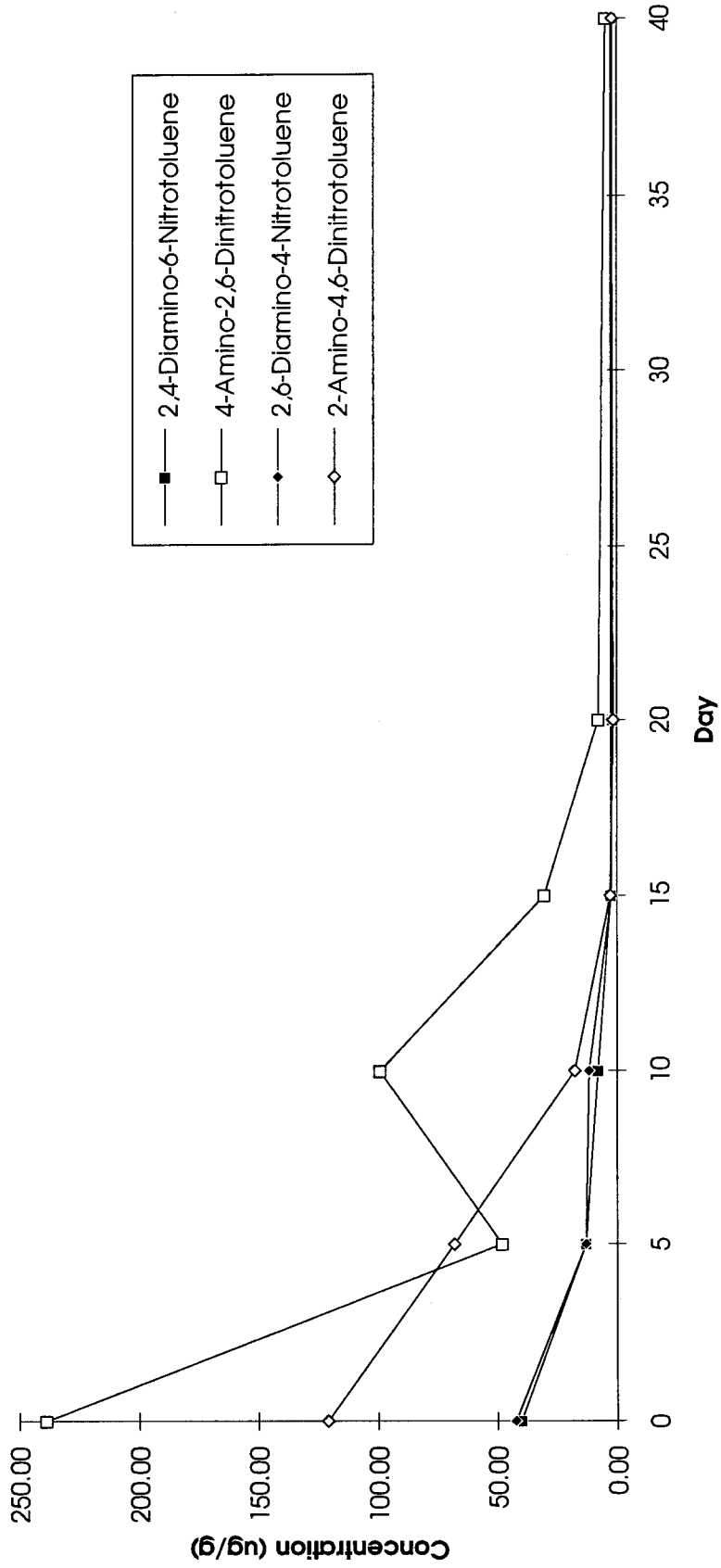

FIGURE 5-29 INTERMEDIATES DATA — CONTAMINATED, AERATED WINDROW (CWR7)

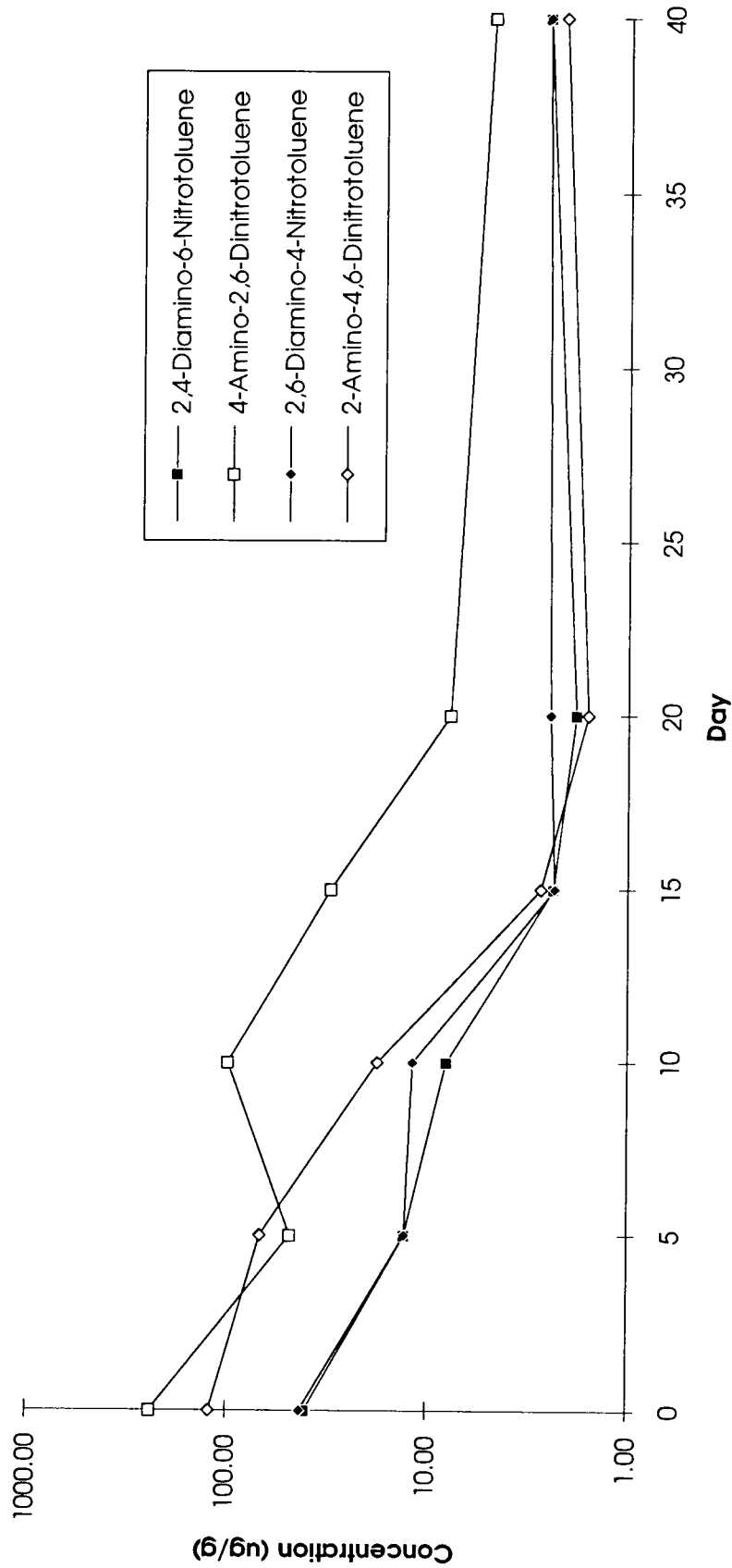

FIGURE 5-30 INTERMEDIATES DATA – CONTAMINATED, AERATED WINDROW (CWR7) (LOGARITHMIC SCALE)

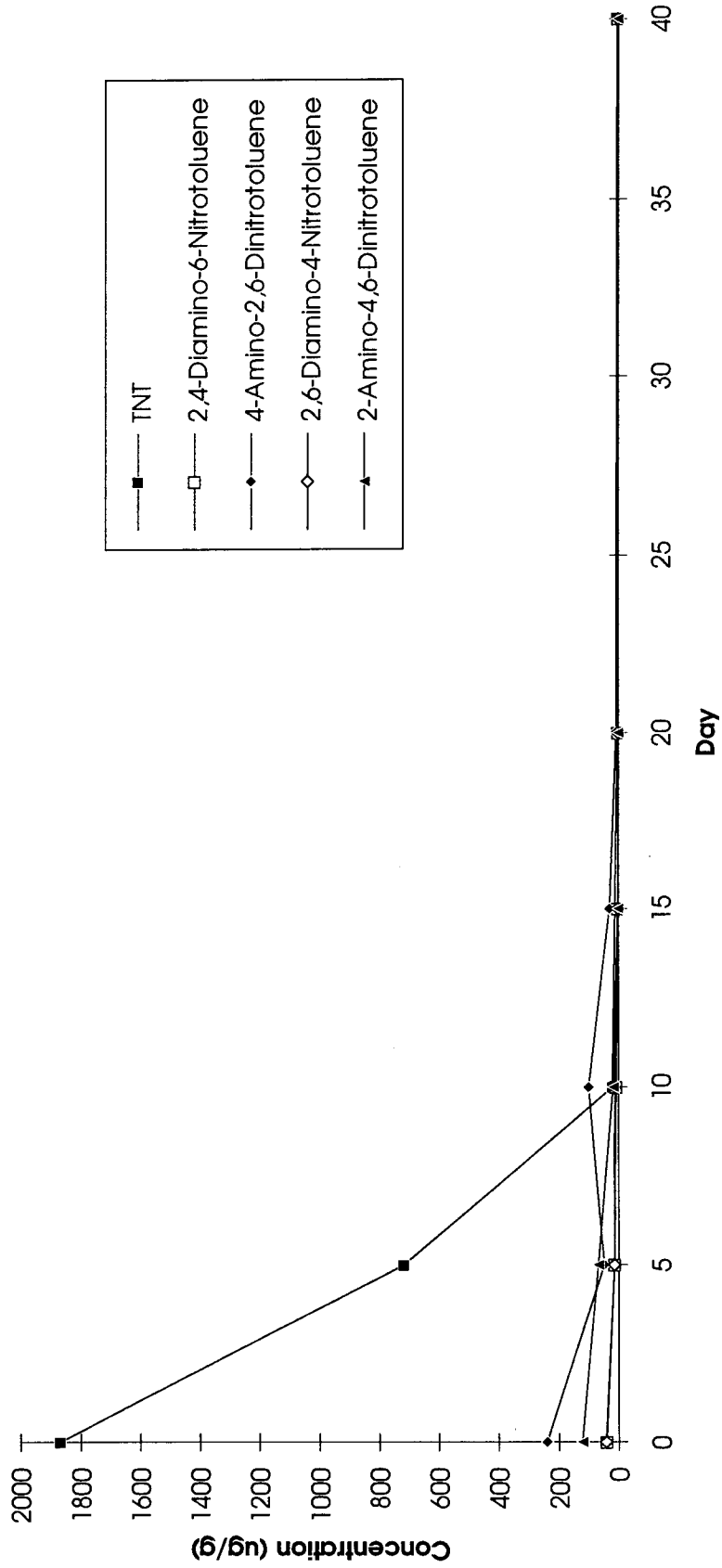

FIGURE 5-31 TNT AND INTERMEDIATES DATA -- CONTAMINATED, AERATED WINDROW (CWR7)

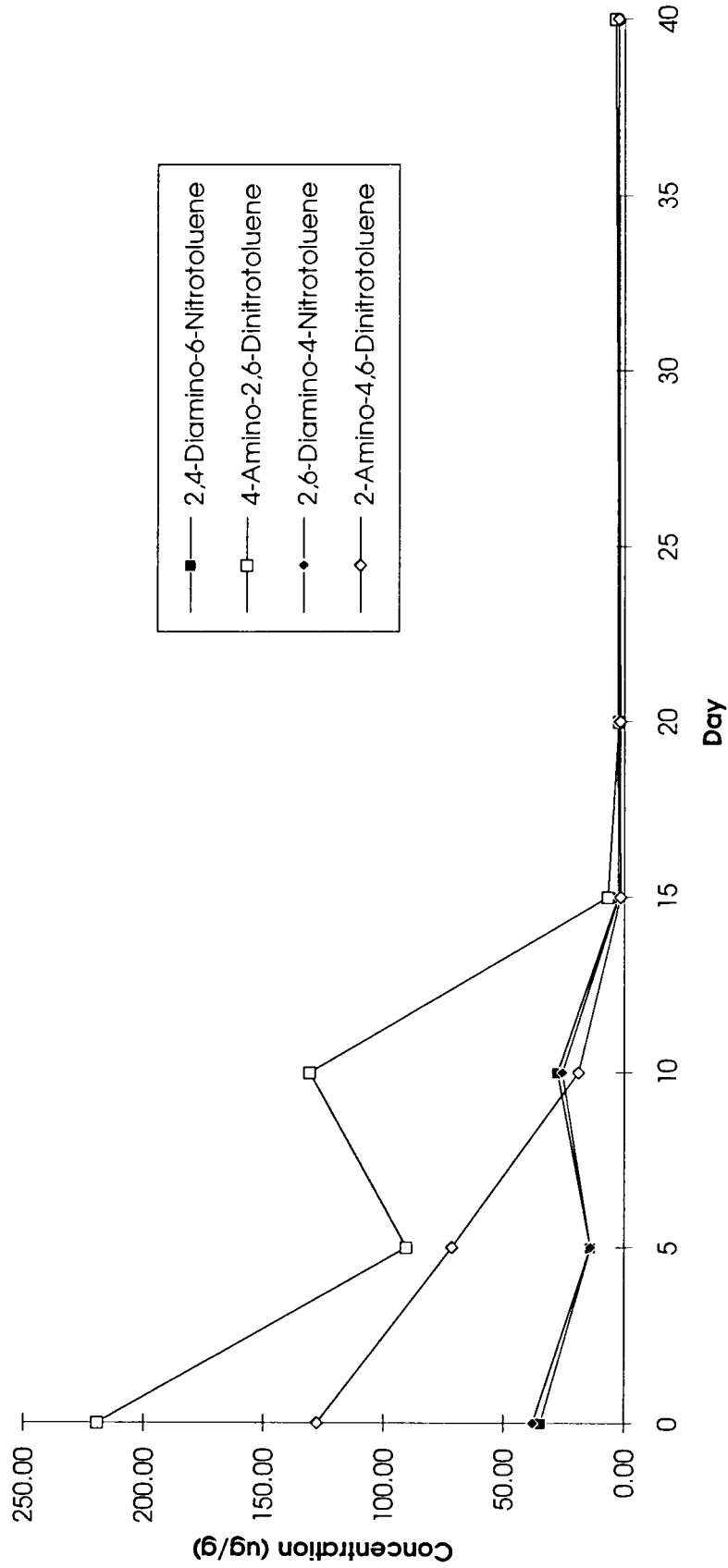

FIGURE 5-32 INTERMEDIATES DATA – CONTAMINATED, UNAEERATED WINDROW (CWR8)

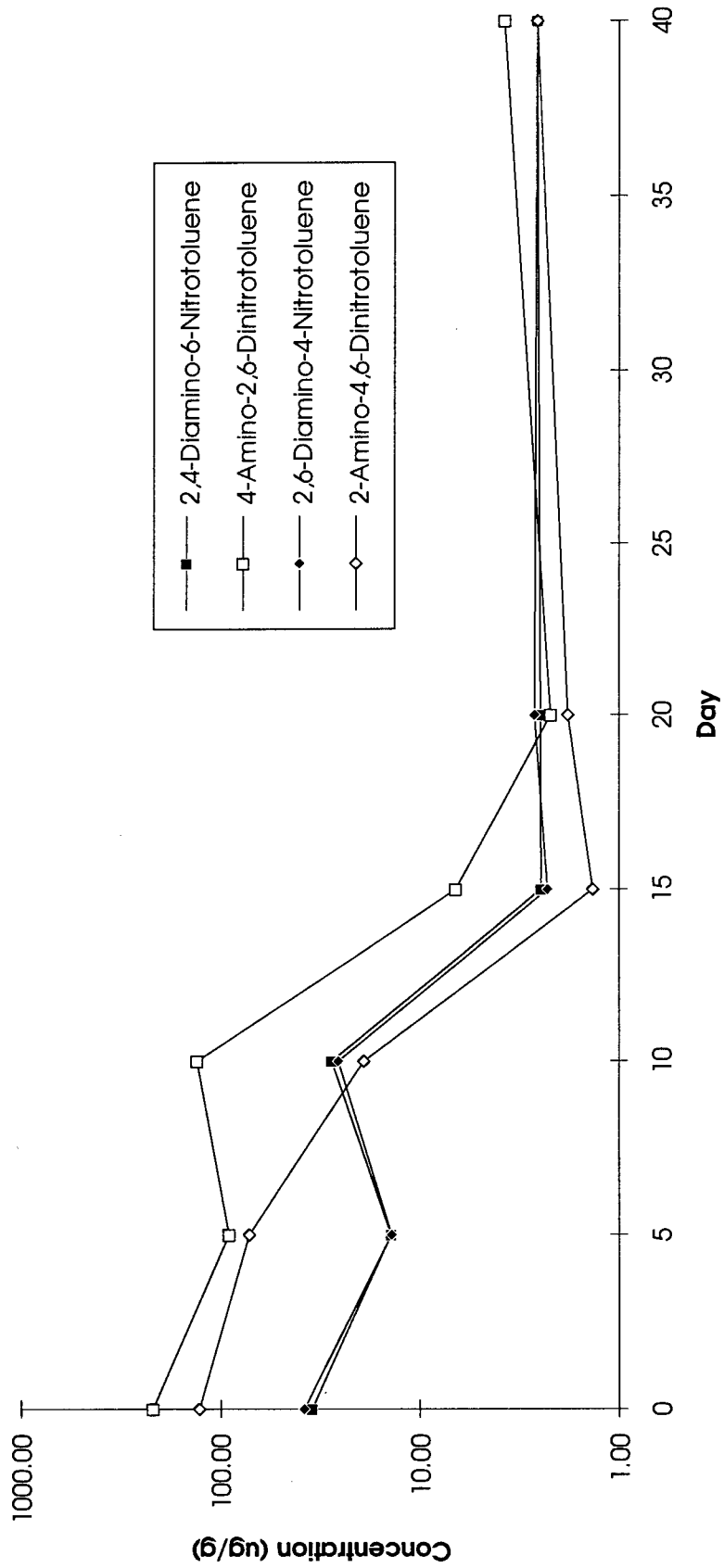

FIGURE 5-33 INTERMEDIATES DATA — CONTAMINATED, UNAERATED WINDROW (CWR8) (LOGARITHMIC SCALE)

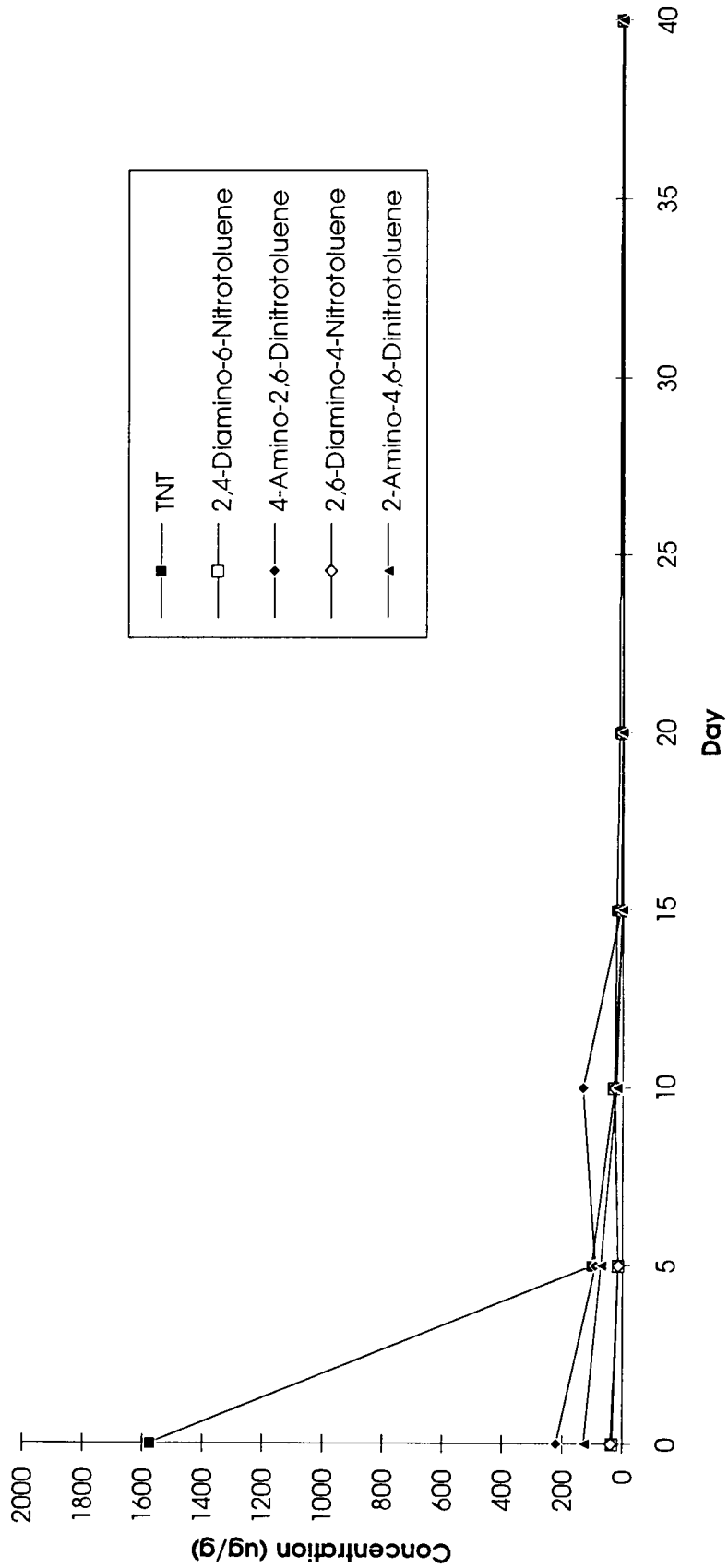

FIGURE 5-34 TNT AND INTERMEDIATES DATA — CONTAMINATED, UNAEERATED WINDROW (CWR8)

5.2.4.11 Kinetics

Explosives removal data were evaluated under the assumption of a first order rate relationship with respect to contaminant concentration, represented mathematically as $C=C_0e^{-kt}$ where,

- C = concentration of constituent at Time t
- C_0 = concentration of constituent at Time 0
- t = time
- k = first order rate coefficient

Kinetic values were obtained by linear least squares regression analysis of concentration versus time, using the linear transformation of these data. While this expression often describes biological treatment of soil bound contaminants, it is not universally applicable. In addition, the nature of this model does not allow for or incorporate a lag phase (as was observed for HMX and RDX) or other similar effects.

Under a first order model, contaminant data should plot as a straight line (within experimental variability) on semilogarithmic coordinates. As shown in the figures in Appendix H, explosives removal in these studies often did not clearly follow such a pattern. This, combined with the observed lag phase for RDX and HMX, suggests that a simple first order relationship may not adequately describe the kinetics in a windrow-composting system for treatment of explosives contaminated soils.

The results of this evaluation for TNT for which no lag was observed are presented in Table 5-7 for purposes of comparison with previous reports [10,1]. The qualifications noted above should be considered when evaluating these results. At the present time, the use of a simple first order model to predict removals of explosives mixtures from soils by composting does not appear to be reliable.

5.3 SUPPLEMENTAL TESTING RESULTS

5.3.1 ANALYTICAL METHOD COMPARISON

Samples from the seeding and windrow composting demonstration were analyzed for explosives concentrations using USATHAMA Method LW02, modified for the analysis of compost samples. This method was approved for analyzing explosives for this research and development demonstration project, and was also the method used in all previous USATHAMA composting projects. Following the completion of the study, a comparison was conducted between this modified Method LW02 and USEPA Draft Method 8330 using samples remaining from the contaminated windrow study. This comparison was conducted in an attempt to evaluate the extraction efficiency of the two methods.

A summary of this method comparison study is presented in Appendix H. The results of the comparison, presented in Table 5-9, indicate that USEPA Draft Method 8330 may provide a higher extraction of explosives from compost samples than USATHAMA

Method LW02. The use of USEPA Method 8330 would not have significantly affected the results and conclusions of the seeding and windrow composting demonstration; however, because the method has the potential to underestimate explosives concentrations, it is recommended that USEPA Method 8330 be used for all future treatability and remediation projects.

5.3.2 OAK RIDGE NATIONAL LABORATORY

A comparison of the overall results of the chemical and toxicological analyses performed by Oak Ridge National Laboratory is presented in Table 5-9. This table summarizes the percent reduction in both aquatic toxicity and mutagenicity of the compost samples over the first 40 days of the study, as well as the percent reduction in explosives concentrations in CCLT extracts during this same period. Substantial reductions in toxicity and leachability were achieved in both windrows. A closer inspection of the data demonstrates slightly better performance of the unaerated windrow (CWR8). This is evidenced by the better reduction in mutagenicity (TA-100 strain) and greater reduction in extractable HMX concentrations in the CCLT leachate in the unaerated windrow as compared to the aerated windrow (CWR7) [12].

5.3.2.1 CCLT Results

The results of the CCLT testing are presented in Table 5-10 for both the contaminated windrows and for the control samples taken from uncontaminated windrows 5 and 6 (UWR5 and UWR6). This table gives the concentrations of explosives and intermediates detected in CCLT extracts at each sampling interval in the study. Although both windrows demonstrated decreasing concentrations of all analytes over the duration of the study, the removals seemed to occur more rapidly and more efficiently in the unaerated windrow (CWR8). This is evidenced in part by the fact that all analytes were below detection limits by day 20 in CWR8, while in samples taken from the aerated windrow (CWR7), detectable concentrations of some of the analytes were still present on Days 40 and 53.

5.3.2.2 Toxicity

Toxicity studies can usually be divided into two categories: (1) acute, and (2) chronic studies. Acute studies generally involve a single short-term exposure of the test organism to a relatively high concentration of the toxic agent, with mortality being the criteria for measurement. Chronic studies, on the other hand, involve a long-term exposure to lower concentrations of the toxic agent with the measurable effect being changes in such criteria as growth, reproduction, and offspring survival [8].

In the aquatic toxicity studies conducted by ORNL, the test organisms were evaluated for both mortality and reproductive inhibition. Based on the data, a dose-response curve was developed to predict both the concentration of leachate (i.e., percent raw leachate) that will kill 50% of the test organisms in seven days, and the concentration that will lower the mean reproduction to 15.0 offspring per female. These values are referred to as the LC_{50} and the SR_{15} values, respectively.

Table 5-9
UMDA Compost
Method Comparison

	Day 0 (mg/kg)											
	Replicate 1			Replicate 2			Replicate 3			Replicate 4		
	USAEC LW02	USEPA 8330	USAEC LW02	USEPA 8330	USAEC LW02	USEPA 8330	USAEC LW02	USEPA 8330	USAEC LW02	USEPA 8330	USAEC LW02	USEPA 8330
TNT	1,680	2,200	1,850	2,200	1,800	2,200	1,870	2,200	1,870	2,200	2,200	2,200
RDX	1,150	1,300	1,270	1,300	1,260	1,300	1,360	1,300	1,360	1,300	1,300	1,300
HMX	1.85 J	230	208 J	220	208 J	210	223 J	210	223 J	210	210	210
TNB	1.79 J	4.0	2.05 J	4.0	1.93 J	4.0	2.02 J	4.0	2.02 J	3.7	3.7	3.7
2,6-DNT	0.79 U	0.49 U	0.79 U	0.47 U	0.74 U	0.48 U	0.78 U	0.48 U	0.78 U	0.49 U	0.49 U	0.49 U
2,4-DNT	1.95	4.1	2.24	3.7	2.36	3.3	2.27	3.3	2.27	3.0	3.0	3.0
Day 40 (mg/kg)												
	Replicate 1			Replicate 2			Replicate 3			Replicate 4		
	USAEC LW02	USEPA 8330	USAEC LW02	USEPA 8330	USAEC LW02	USEPA 8330	USAEC LW02	USEPA 8330	USAEC LW02	USEPA 8330	USAEC LW02	USEPA 8330
	USAEC LW02	USEPA 8330	USAEC LW02	USEPA 8330	USAEC LW02	USEPA 8330	USAEC LW02	USEPA 8330	USAEC LW02	USEPA 8330	USAEC LW02	USEPA 8330
TNT	7.13	2.8	2.15	2.1	2.62	2.5	2.54	2.5	2.54	3.0	3.0	3.0
RDX	2.88	3.0	2.02	2.7	1.90 J	2.1	2.40	2.1	2.40	2.0	2.0	2.0
HMX	2.15 J	2.8	1.89 J	3.3	1.90 J	2.5	1.86 J	2.5	1.86 J	2.3	2.3	2.3
TNB	0.46 J	0.77 J	0.43 J	0.58 J	0.45 J	0.68 J	0.42 J	0.68 J	0.42 J	0.59 J	0.59 J	0.59 J
2,6-DNT	0.82 U	0.52 U	0.82 U	0.51 U	0.80 U	0.49 U	0.77 U	0.49 U	0.77 U	0.50 U	0.50 U	0.50 U
2,4-DNT	0.86 U	0.52 U	0.86 U	0.51 U	0.84 U	0.49 U	0.81 U	0.49 U	0.81 U	0.50 U	0.50 U	0.50 U

Table 5-10
Comparison of Percent Reduction in Chemical/Toxicity
Parameters in Contaminated Windrows Over 40 Days

Windrow	Leachable Explosives ^a (% Reduction)			Leachate Toxicity ^b (% Reduction)		Extractable Mutagenicity ^c (% Reduction)	
	TNT	RDX	HMX	Survival	Fecundity	TA-98	TA-100
CWR7 (aerated)	>99.6	97.7	52.5	91	91	98.9	86.0
CWR8 (non-aerated)	>99.6	>98.6	>97.3	92	87	99.6	99.3

^aPercent reductions in the concentrations of explosives in EPA Synthetic Precipitation Leaching Test Leachate (SW-846 Method 1312).

^bPercent reductions in leachate toxicity to Ceriodaphnia dubia as estimated by % reductions in 1/LC₅₀ and 1/SR₁₅.

^cPercent reductions in acetonitrile-extractable specific mutagenic activity determined using strains TA-98 and TA-100, both without S-9 metabolic activation.

The aquatic toxicity results obtained for the leachates from the windrow samples are presented in Table 5-11. This table presents both the LC₅₀ and the SR₁₅ values obtained using Ceriodaphnia dubia as the test organism. From the data it is apparent that the toxicity of leachates extracted from the composts are significantly reduced by Day 40 of the study. Samples extracted on Day 1 of the study demonstrated both significant mortality and reproductive inhibition. By Day 15, however, the detoxification appeared to be complete in both the aerated and the unaerated contaminated windrows [12]. This detoxification appears to correlate with the disappearance of leachable explosives in the CCLT extracts.

The preliminary results of the mutagenicity tests are presented in Table 5-12. These data indicate that both windrows demonstrated a decrease in specific mutagenicity throughout the 40-day test period. However, the unaerated windrow appears to have shown a more rapid detoxification than the aerated windrow. This is evidenced by the consistently lower specific mutagenicity values of windrow CWR8 with respect to CWR7 for samples taken on Days 15 and 40. The results of the toxicity studies will be presented further in a separate report.

**Table 5-11
CCLT Leachate Data for Windrow Studies**

Windrow	Day	Concentration (mg/L)							
		2,6-DA-4-NT	2,4-DA-6-NT	2-A-4,6-DNT	4-A-2,6-DNT	TNT	RDX	HMX	
CWR7 (aerated)	1 ^a	<1.10	<1.10	3.91 ± 0.36	8.25 ± 0.36	22.4 ± 0.1	19.0 ± 0.3	6.96 ± 0.49	
	5 ^b	<0.73	<0.73	5.26 ± 0.42	10.1 ± 0.6	5.76 ± 0.04	20.2 ± 0.2	6.69 ± 0.23	
	10	<0.55	2.69 ± 0	<0.65	1.51 ± 0.12	<0.50	12.9 ± 0.2	6.36 ± 0.05	
	15	<0.44	0.56 ± 0.05	<0.52	<0.40	<0.40	2.0 ± 0.1	4.31 ± 0.34	
	20	<0.11	0.66 ± 0.07	<0.13	<0.10	<0.10	0.55 ± 0.05	3.86 ± 0.34	
	40	<0.11	0.19 ± 0.01	<0.13	0.32 ± 0.02	<0.10	0.44 ± 0.02	3.32 ± 0.15	
	53 ^e	<0.25	<0.25	<0.25	<0.25	0.041	0.033	0.589	
CWR8 (non-aerated)	1 ^b	<0.10	<1.10	5.41 ± 0.49	11.4 ± 0.7	26.5 ± 0.2	20.2 ± 0.3	7.52 ± 0.37	
	5	1.38 ± 0.56	2.40 ± 0.31	7.22 ± 0.24	21.4 ± 0.5	<0.67	20.5 ± 0.2	7.24 ± 0.28	
	10	1.18 ± 0.02	8.46 ± 0.11	<0.65	1.51 ± 0.07	<0.50	17.8 ± 0.1	7.91 ± 0.28	
	15	<0.47	≤0.47	<0.52	<0.40	<0.40	0.99 ± 0.03	3.23 ± 0.09	
	20	<0.11	<0.11	<0.13	<0.10	<0.10	<0.24	≤0.21	
UWR5	40 ^c	<0.11	<0.11	<0.13	<0.10	<0.10	<0.24	<0.19	
	53 ^e	<0.154	<0.154	<0.154	<0.154	<0.016	<0.013	<0.026	
	40+ ^d	<0.11	<0.11	<0.13	<0.10	<0.10	<0.24	<0.19	
UWR6	40+ ^d	<0.11	<0.11	<0.13	<0.10	<0.10	<0.24	<0.19	
	Blank	<0.11	<0.11	<0.13	<0.10	<0.10	<0.24	<0.19	

^aLeachate also contains 0.25 mg/L of what appears to be azoxydimer.

^bLeachate also contains 0.1 mg/L of what appears to be azoxydimer.

^cLeachate may have traces (<0.1 mg/L) of RDX and HMX.

^dCompost aged additional 2 weeks without turning or aeration.

^eResults obtained by WESTON Analytics.

Table 5-12

**Concentration of Compost Leachate (in Percent of Full-Strength)
Required to Kill 50% of the Test Organisms in 7 Days (LC₅₀) or
to Lower Mean Reproduction to 15.0 Offspring per Female (SR₁₅)**

Study	Duration of Composting (days)	LC ₅₀ (%)	SR ₁₅ (%)
CWR7 (aerated)	1	4.5	1.3
	5	10.0	2.7
	10	5.0	3.4
	15	>10	>10
	20	>20	>20
	40 ^a	49.0	14.0
CWR8 (non-aerated)	1	4.0	1.9
	5	5.0	2.7
	10 ^b	1.8	0.9
	15	>10	>10
	20	>20	>20
	40 ^a	47.5	14.2
UWR5 (aerated)	---	>20	>20
UWR6 (non-aerated)	---	>20	>20
Blank (20%)	---	>20	>20

^aFresh leachate samples were prepared and retested at higher concentrations (20, 40, and 60% of full-strength) to derive more accurate estimates of LC₅₀ and SR₁₅ values. In these tests, SR₁₅ values were obtained graphically by interpolating between mean reproduction in the control (30.7 ± 4.4 offspring per female) and mean reproduction in the lowest tested concentration of each leachate.

^bSurvival and reproduction data for this test are suspiciously low, but no unusual conditions that could account for the apparent aberrations were found.

**Table 5-13
Preliminary Results for Ames Testing of Acetonitrile Extracts from Windrow Composts**

Windrow	Day	Specific Mutagenicity Revertants/g of Compost (Avg. ± S.D.)					
		TA-98			TA-100		
		+ S-9	- S-9	+ S-9	- S-9	+ S-9	- S-9
CWR7 (Aerated)	1	1,070,000 ± 89,000	760,000 ± 60,200	207,000 ± 18,300	105,000 ± 20,100		
	5	136,000 ± 18,400	315,000 ± 19,600	63,000 ± 6,550	84,200 ± 6,610		
	10	20,200 ± 880	28,700 ± 886	4,780 ± 850	17,200 ± 1,340		
	15	10,700 ± 229	14,100 ± 553	1,970 ± 833	8,730 ± 222		
	20	5,940 ± 406	12,100 ± 658	1,060 ± 268	6,070 ± 966		
	40	4,490 ± 339	5,900 ± 586	1,110 ± 618	2,180 ± 179		
CWR8 (Nonaerated)	1	700,000 ± 81,600	937,000 ± 91,600	140,000 ± 8,170	154,000 ± 2,930		
	5	19,600 ± 637	44,700 ± 1,980	14,800 ± 1,880	38,200 ± 3,750		
	10	3,600 ± 282	28,000 ± 906	11,400 ± 561	36,300 ± 2,190		
	15	1,270 ± 213	10,900 ± 372	2,470 ± 147	7,340 ± 506		
	20	1,350 ± 219	5,290 ± 598	1,220 ± 308	5,210 ± 473		
	40	595 ± 196	2,800 ± 280	1,340 ± 268	3,160 ± 131		
UWR5 (Aerated Control)	40+ ^a	933 ± 115	310 ± 73	403 ± 164	291 ± 92		
UWR6 (Nonaerated Control)	40+ ^a	188 ± 38	256 ± 136	479 ± 139	708 ± 171		
Blank	---	280 ± 61	417 ± 107	273 ± 255	190 ± 169		

^aControl composts with noncontaminated soil aged additional 2 weeks without turning or aeration.

SECTION 6**DISCUSSION****6.1 SEEDING STUDY**

The goal of the seeding study was to evaluate whether recycling of active compost into subsequent compost batches would result in improvements in the rate and/or extent of explosives transformation. Based upon microbiological and biological process engineering principles, there are several ways in which such recycle may improve performance. Improvements in the rate of heating may result from inoculation of the pile with high numbers of active thermophilic organisms. A decrease in the observed lag period may also be achieved. In addition to improvements in overall population levels or activity, it is possible that long-term repeated exposure to the contaminants may result in an acclimated population with high specific activity against those contaminants.

However, the results achieved for the seeding study do not provide indisputable evidence that recycling compost from one cycle to the next resulted in greater explosives breakdown or removal rates, at least not under the conditions tested. Successive studies did show improving removal efficiency for RDX. However, improvements were generally observed in both the control and seed reactors.

There are several possible reasons for these results. In terms of overall population levels, it should be recognized that the amendment mixture itself likely contributes large numbers of microorganisms in comparison to the relatively small net increase in population levels contributed by the recycle compost. Insofar as the ability to transform explosives has not been found to be limited to a narrow range of organisms [11], such a nonspecific and nonadapted population, as provided by the amendment mixture, may be sufficient for explosives transformation. As to whether an acclimated population with particular capabilities may develop (such as the ability to mineralize rather than merely transform explosives), such effects are not apparent from explosives removal data alone, and additional investigations to evaluate this possibility were not conducted.

It is also possible that the upsets in the temperature control system and the resulting temperature fluctuations may have masked the effects of seeding. Another possibility is that compost residue in the tanks between cycles provided some degree of seeding even in control reactors. Finally, it is possible that the effects of seeding may not begin to manifest themselves after only four cycles.

Based upon these results from the seeding study, there does not appear to be a need to incorporate compost recycle into explosives compost operating strategies. It should be recognized that longer and more extensive testing of this approach may yet yield some improvements. Because there are relatively few, if any, negative effects likely from recycle of a small amount of compost, it is possible that this operation could be conducted routinely in an effort to enhance performance. It should also be recognized

that some degree of inadvertent recycling will likely occur at full scale as a result of the incorporation of residue from finished compost piles into subsequent batches.

6.2 WINDROW STUDIES

The overall goal of the windrow composting test was to evaluate whether this technical approach could be used to bioremediate explosives contaminated soils. There are several principle components that must be considered in addressing this goal:

- Whether successful thermophilic composting of soil matrices can be achieved and sustained in windrow operations, as assessed by conventional composting parameters such as temperature, pH, moisture, and aeration.
- The level of soils loadings that can be achieved in the compost mixture under the above conditions.
- The rate and extent of explosives transformation achievable under windrow composting conditions.
- The acceptability of the final compost product with respect to such parameters as explosives/intermediates breakdown products, leachability/mobility of contaminants and intermediates, and toxicity reduction.

These factors have been evaluated in this windrow composting field demonstration and associated testing programs (ORNL study). In general, the results of these studies demonstrate that windrow composting will be successful under all of the above criteria.

Uncontaminated windrow testing demonstrated that thermophilic composting conditions could be achieved and sustained at soil loadings up to 30% by volume (the highest value tested). In addition to acceptable temperature profiles, pH and moisture characteristics were similar to those achieved in previous tests of other composting technologies. The uncontaminated windrow tests also demonstrated that while the windrow turning operation was successful in terms of mixing the compost, the aeration provided by this operation was short-lived. Additional testing demonstrated that supplemental mechanical aeration could easily be added to the windrow operation if necessary.

Contaminated windrow testing demonstrated that windrow composting may perform comparably to, or better than, previously tested approaches. Rapid and near complete removal/transformation of TNT was achieved. RDX removal exhibited an apparent lag phase, but was also effective. Substantial removal of HMX was also observed. The majority of removal was complete in 20 days or less. Explosives intermediates data indicate that these constituents were effectively removed or transformed in the process.

A critical question in the implementation of windrow composting concerns whether supplemental mechanical aeration is required for effective explosives transformation

and to achieve other process goals. Previous tests of composting for explosives contaminated soils have employed highly aerobic conditions. Based upon the results of this testing program, the conventional unaerated windrow approach performed as well as or better than the windrow supplemented with mechanical aeration. In particular, the low observed interstitial oxygen levels did not hamper the effectiveness of the process in terms of removal of explosives/intermediates. There are a variety of factors that may contribute to this observation. Research literature indicates that anaerobic transformation of nitroaromatics is possible. Furthermore, the level of interstitial oxygen needed for effective transformation of explosives even under aerobic composting conditions is not known. Based upon data from this test, interstitial oxygen levels in the low percent range appear to be fully adequate for effective removal of TNT, RDX, and HMX. These data also demonstrated that more aerobic conditions do prevail in the pile toward the end of the composting period. While the effect of this period on final compost quality cannot be discerned from this test, the aerobic period may contribute to final stabilization of the product.

Temperature performance of the conventional unaerated windrows was also interesting. Even in the absence of supplemental aeration, thermophilic conditions were achieved and maintained. At the same time, overheating of the windrow in the absence of ventilative heat removal (other than that provided by daily windrow turning) was not an observed problem. These data suggest a degree of self-regulatory properties of the compost matrix. In fact, strict comparison between unaerated and aerated windrows suggests that the former may heat more slowly and also remain warm longer, such that high peak temperatures are avoided and the composting period is effectively extended in the conventional unaerated windrow process.

Superior performance of the conventional unaerated windrow in comparison to the mechanically aerated windrow was also demonstrated for reduction of mobility and toxicity. Both windrows exhibited non-toxic results by day 20 of the study for leachate samples at the highest concentration tested (20% leachate). For the mutagenicity studies, however, the toxicity reduction in the unaerated windrow was slightly more efficient. In addition, the overall reduction in the leachability of HMX was greater in the unaerated windrow.

The effect of the mechanical aeration system may be to increase overall microbial activity and consume organic substrates more rapidly. While this may be desirable for overall waste stabilization composting, it may not be advantageous where longer-term, even heating is needed for specific contaminant treatment.

An additional observation from these studies is that the unaerated windrow, requiring no external temperature control system is, of course, less prone to mechanical upsets which affect temperature. Many of the observed temperature fluctuations in aerated systems in this and previous studies have been associated with malfunctions in the blower control systems, leading to overheating when blowers were not activated, or leading to overcooling when blowers remained on too long. While such mechanical problems are correctable, some equipment reliability problems might be expected during extended full-scale operation.

As noted previously, effective thermophilic composting conditions were observed at both daily and less frequent (three times per week) turning intervals (at soil ratios as high as 20% by volume, the highest value for which two turning frequencies were examined). In light of the effective removal/transformation of explosives observed at low interstitial oxygen levels, it seems reasonable to presume that reduced turning frequencies may also be acceptable in terms of explosives treatment. However, because this parameter was not varied during contaminated windrow testing, this presumption should be verified prior to adopting a reduced turning frequency.

SECTION 7**LESSONS LEARNED**

In addition to the specific technical data, results, and conclusions developed in this testing program, a variety of additional observations were drawn that may prove valuable in the implementation of composting for explosives-contaminated soils. These lessons may relate to various design and operating requirements. Many of these observations are not directly quantifiable; however, they are the result of extensive operating experience. Actions taken in response to these observations are not expected to substantially affect the composting process, although in some instances verification may be required. The following general observations have been drawn:

- Composting operations inside the temporary structure resulted in reduced visibility caused by the release of water vapor from the compost during turning. In addition, accumulation of ammonia in the released gas was noted. Remedial measures taken in this study included the use of additional exhaust fans, modified or additional personal protective equipment and modified operating procedures. While these measures proved adequate for purposes of this testing program, full-scale ventilation requirements should be evaluated to provide adequate protection and maximize productivity.
- In addition to windrow monitoring and turning, additional maintenance is required to maintain the shape and configuration of the windrows. A small front end loader was found to be suitable for this purpose. Maintenance of the windrows was further complicated by the inclusion of an aeration system. The piping network underlying the windrow had to be disconnected from the blowers prior to mixing, and then reconnected afterwards. Also, before each turning, the height of the windrow turner was measured to ensure that the flails would not come in contact with the bed of woodchips or the buried network of pipes. Finally, during reconstruction of the windrow after turning, extra care was required by the front-end loader operator to ensure that the piping network was not disturbed.
- Water supply requirements for full-scale operations should be considered. Based upon the results of this study, substantial quantities of water may be required to replace moisture lost during the composting process and maintain adequate moisture levels. Potable water can be used for this purpose. It may also be possible to use other water sources including water from a dedicated well, or excess water from other required site activities such as soil or rock washing if implemented. The suitability of these sources must be evaluated prior to their use, however, to ensure that the constituents in the water do not adversely affect the composting process.

- The commercially available windrow turner performed well mechanically and provided good results in composting operations. Although this (or, presumably other comparable) machines can be used directly in full-scale operations, some modifications may be useful to optimize performance. Explosives-hazards-related recommendations are summarized in Appendix E. Additional process-related factors to consider include the following:
 - Variable drum or mixer speed to adjust mixing intensity.
 - Exhaust filtration to facilitate inside operations.
 - The addition of deflectors and/or baffles to minimize the tendency to throw materials (such as small stones) from the compost during turning.
- Field instrumentation, as used in this study, is suitable for monitoring the composting process. The accuracy of the oxygen-monitoring equipment was limited below approximately 1% oxygen; however, this value was found to be adequate for monitoring purposes. Although certain instruments were affected by the physical conditions in the composting environment (including corrosion), adequate inspection and maintenance provided reliable process monitoring.
- As a demonstration project, this study used a high level of process monitoring. It is reasonable to anticipate that less intensive operations and monitoring will prove adequate at full scale. Decreased process monitoring (number and frequency of monitoring locations) will result in direct cost savings for analytical costs and indirect savings in operating labor. Reduced windrow turning frequency may also prove suitable and further reduce costs; however, testing may be required to verify that this operating change will not diminish process performance.
- Improvements in compost sample preparation and analysis protocols will improve operations, if technically feasible. Field analytical methods for explosives in compost would be useful in process monitoring, with laboratory analyses used for confirmation of cleanup criteria. Modifying the compost sample preparation procedure to minimize drying time will facilitate rapid redispersion of finished compost.
- The USATHAMA Method LW02 was approved and used for analyzing explosives for this research and development demonstration project and all previous USAEC composting projects. Following the completion of the study, a comparison of EPA SW846 Draft Method 8330 and USATHAMA Method LW02 determined that the use of USATHAMA Method LW02 has the potential to affect the extraction efficiency of the samples. For this reason, it is recommended that EPA SW846 Draft Method 8330 be used

for future explosives and composting treatability studies and remediation projects. A comparison of the two methods is in Appendix H.

- The windrow composting studies were successfully conducted under a wide range of ambient temperatures. Thermophilic conditions were attained during summer months when daytime highs were well above 100°F, as well as during late autumn when nighttime lows dropped below freezing. From these observations, it appears that with proper containment within an enclosure and with slight adjustments to turning frequency to control heat losses from the material, windrow composting can be implemented year round.

SECTION 8**CONCLUSIONS**

Based on the data and observations from this windrow and seeding composting test program, the following major conclusions are drawn:

- Windrow composting can effectively be used to bioremediate soils/sediments contaminated with TNT, RDX, and HMX.
- The conventional (unaerated) windrow approach performs as well as or better than a mechanically aerated windrow method.
- Windrow composting performance was comparable to, or better than, previously tested aerated static pile (ASP) and mechanically agitated invessel (MAIV) composting in terms of the rate and extent of explosives removal.
- Effective removal of both explosives (TNT, RDX and HMX) and selected TNT intermediates was achieved by windrow composting.
- EPA SW846 Draft Method 8330 should be used for analyses in future explosives and composting efforts to achieve improved extraction efficiencies and, therefore, more accurate results.
- Preliminary data indicates that windrow composting will provide a high degree of reduction in mobility and toxicity, as was demonstrated for ASP and MAIV technologies.
- Soil loadings as high as 30% by volume (the highest value tested) can be successfully composted in a windrow system.
- The windrow composting technology is relatively simple to implement and operate. Commercially available equipment may be used, although some modifications may be warranted to optimize their characteristics.
- The use of temporary construction shelters can be used for windrow composting. However, particular attention to adequate ventilation is warranted to minimize operating problems.
- Over the range of conditions examined, no clearly demonstrable effect of compost recycling on the rate or extent of explosives removal was observed.
- With proper containment and manipulation of turning frequencies, windrow composting can be successfully implemented year-round.



SECTION 9

REFERENCES

1. WESTON (Roy F. Weston, Inc.). 1991. Optimization of Composting for Explosives Contaminated Soil, Final Report, prepared for USAEC, Report Number CETHA-TS-CR-91053.
2. Finstein, M.S., F.C. Miller, and P.F. Strom. 1986. "Waste Treatment Composting as a Controlled System," Biotechnology, Eds. H.J. Rehm and G. Reed. VCH, New York, NY.
3. CH2M Hill and Morrison Knudsen Environmental Services. 1992. Final Report: Feasibility Study for the Explosives Washout Lagoons (Site 4) Soils Operable Unit, Umatilla Depot Activity (UMDA) Hermiston, Oregon, prepared for USAEC, Report Number CETHA-BC-CR-92017.
4. Brock, T.D. and MT. Madigan. 1988. Biology of Microorganisms. Fifth Edition. Prentice-Hall Publishing, Englewood Cliffs, NJ.
5. WESTON. 1988. Field Demonstration—Composting of Explosives-Contaminated Sediments at the Louisiana Army Ammunition Plant (LAAP). Final Report, prepared for USAEC, Report Number AMXTH-IR-TE-88242.
6. WESTON. 1989. Composting of Explosives-Contaminated Soils Technology Draft Final Report, prepared for USAEC.
7. WESTON. 1989. Field Demonstration—Composting of Propellants-Contaminated Sediments at the Badger Army Ammunition Plant (BAAP), Final Report, prepared for USAEC, Report Number CETHA-TE-CR-89216.
8. Rand, G.M. and S.R. Petrocelli. 1985. Fundamentals of Aquatic Toxicology. Hemisphere Publishing Corporation, New York, NY.
9. Oak Ridge National Laboratories. 1990. Characterization of Explosives Processing Waste Decomposition Due to Composting, prepared for U.S. Army Medical Research and Development Command, Project Order Number 89PP9921.
10. Atlantic Research Corporation. 1986. Composting Explosives/Organics Contaminated Soils, Final Technical Report, prepared for USAEC, Contract No. DAAK11-84-C-0057.
11. Kaplan, D.L., and A.M. Kaplan, 1982c. "Thermophilic Biotransformations of 2,4,6,-Trinitrotoluene Under Simulated Composting Conditions." Applied Environmental Microbiology. 44:757-760. Natick/TR-82/015.



12. Oak Ridge National Laboratory. April 1993. Characterization of Explosives Processing Waste Decomposition Due to Composting. Preliminary Data, U.S. Army Project Number 89PP9921, Department of Energy Number 10-16-123-A1.

APPENDIX A

SUPPLIERS/MANUFACTURERS/SPECIFICATIONS

Vendors and Amendment Suppliers

Available Windrow Compost Turners

KW Manufacturers Specifications – Model 614

Manufacturers of Temporary Structures

KW Model-614 Manufacturers Specifications

Clamshell Manufacturers Specifications

**Vendors and Amendment Suppliers
Used on the UMDA Project**

Service Material	Supplier	Address	Phone No.	Contact
Sawdust	Sunrise Corporation	P.O. Box 1146 Hermiston, OR 97838	503-567-2100	Sam Clow
Alfalfa	Mills Mint Farms	Box 84 Stanfield, OR 97875	503-449-3360	Marvin Mills
Potatoes	Lamb-Weston Corp.	Westland Road Hermiston, OR 97838	503-567-2211	Tom Wansley
Chicken Manure	Columbia Egg Farm	P.O. Box 98 Rufus, OR 97050	503-739-2244	Terry Hudgens
Cow Manure	Hillview Dairy	East Wilson Road Boardman, OR	503-481-4295	Kurt Gantenbien
Equipment Rental	STAR Rentals	1912 West A St. Pasco, WA	509-545-8521	Jim
Hauling & Excavating	Wesley Wise Excavating	Rt. 2, Box 159 Irrigon, OR 97884	503-922-4384	Wes Wise
Hauling, Excavation, Labor (Haz. Mat. Certified Laborers)	Mid Columbia Excavation	307 Columbia Ave. NW Boardman, OR	503-481-5531	Alan and Sheryl Holmes
Electrical Contracting	Ray Peterson Electric	54 Aloro Dr. Hermiston, OR 97838	503-567-0228	Ray Peterson
Hardware, Feed, and Farm Supplies	Pendleton Grain Growers	200 S. First Pl. Hermiston, OR 97838	503-567-5591	Dick Keplinger
Lumber and Hardware	Copeland Lumber	Hermiston-McNary Hwy. Hermiston, OR 96838	503-567-2550	Karin
Equipment & Tool Rentals	Bestway Equipment Rental	Rt. 2, Box 2376 Hermiston, OR 97838	503-567-6816	
Hardware & Houseware	Coast to Coast	1000 S. Hwy. 395 Hermiston, OR 97838	503-567-6816	Bob or Vicki Smith
Electrical & Plumbing Supply	K.I.E. Supply	Hermiston-McNary Hwy. Hermiston, OR 96838	503-567-3317	
Field Trailer Rental	Redsal Mobil Offices	Hwy. 395 & 19th St. Kennewick, WA 99337	509-586-7174	Patrick Rivers

Summary of Available Windrow Compost Turners

Manufacturer	Model	Belt/Hydraulic Drive	Flail/Flight	Typical Windrow Size
A-1 Environmental	Sims 2000	Hydraulic	Flail	12-14 ft wide 5-6 ft high
Brown Bear Corporation	500	Hydraulic	Auger	12 ft wide 4 ft high
Eagle Crusher Co.	Straddle Master II	Hydraulic	Flail	14 ft wide 4-6 ft high
	Straddle Master II	Belt	Flail	14 ft wide 4-6 ft high
Resource Recovery Systems of Nebraska	KW614	Belt	Flail	14 ft wide 6 ft high
	KW614	Hydraulic	Flail	14 ft wide 6 ft high
Scarab Manufacturing	Model 14	Belt	Flail	14 ft wide 6 ft high
	Model 14	Hydraulic	Flail	14 ft wide 6 ft high
Valoraction, Inc.	Sittler 1012	N/A	Flail	10-12 ft wide 4'8" high
Wildcat Manufacturing	CM750-AME-SPECIAL	N/A	Flail	17 ft wide 5 ft high

Note: An explosive hazard analysis has been performed for the KW614 (used in the UMDA field demonstration [5]). This analysis would be required if any of the windrow turners were used.



**Manufacturers of Temporary Containment Structures
Considered for Use at the Contaminated Windrow Site**

1. Camber Corporation
Sprung Instant Structures
P.O. Box 11041
Pittsburgh, PA 15237
Phone: (412) 367-8626
Fax: (412) 367-1388
Contact: Robert F. Simcik

2. Clamshell Buildings, Inc.
1990 Knoll Drive
Ventura, CA 93003
Phone: (805) 650-1700
Fax: (805) 650-1733

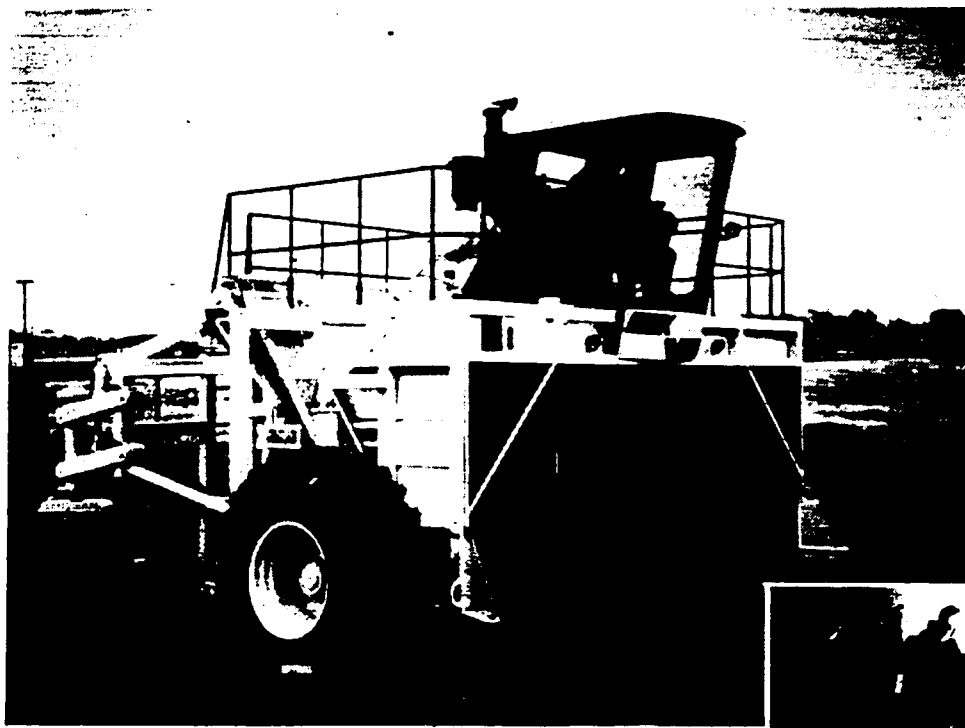

K-W Model 616



DRUM ASSEMBLY

DETAILED MODEL SPECIFICATIONS

	K-W 614	K-W 616-4	K-W 718
Tunnel Dimensions	6'x14'	6'x16'	7'x18'
Engine (Caterpillar)	3306	3406	3406
Engine Horsepower, Max.	300	440	440
Capacity, Tons/Hour (Sludge & Manure)	2000	3000	3000
Capacity, Yds ³ /Hour (Leaves, Yard Waste, MSW)	5000	7500	7500
Drum Drive (Standard)	Belt	Belt	Hydraulic
Weight, Lb.	24,500	26,000	28,000
Overall Width	24 feet	27 feet	29 feet
Overall Height	12'6"	12'6"	13'10"
Overall Length, Front To Rear	12'	15'6"	15'6"
Tire Size (Standard) Front	18.4x26	23.1x26	23.1x26
Tire Size (Standard) Rear	11.5Lx15	16.1x16.5	16.1x16.5
Fuel Consumption, Gal./Hr.	12½	19	19
Fuel Tank Capacity, Gal.	140	225	225

MISCELLANEOUS STANDARD FEATURES

- Twin rear ladders for access each side of machine
- Heavy duty twin disc clutch
- Hand rails enclose deck. Walkways of anti-slip material
- Hydraulic tubing used for fluid lines whenever possible.
- Rear wheel assembly constructed with 3 inch stressproof shaft.

K WINDROW COMPOSTERS

PRESENTING THE

Converts nuisance organic wastes into odor free, easily handled compost.

For Use In:

- Sludge
- Leaves, yard wastes
- Livestock & Poultry Manures
- Municipal solid wastes
- Agricultural residues
- Racetrack wastes
- Packing and cannery wastes
- Paper mill wastes
- Complimentary with other systems
- Mixing for static pile

Options

- Special designs

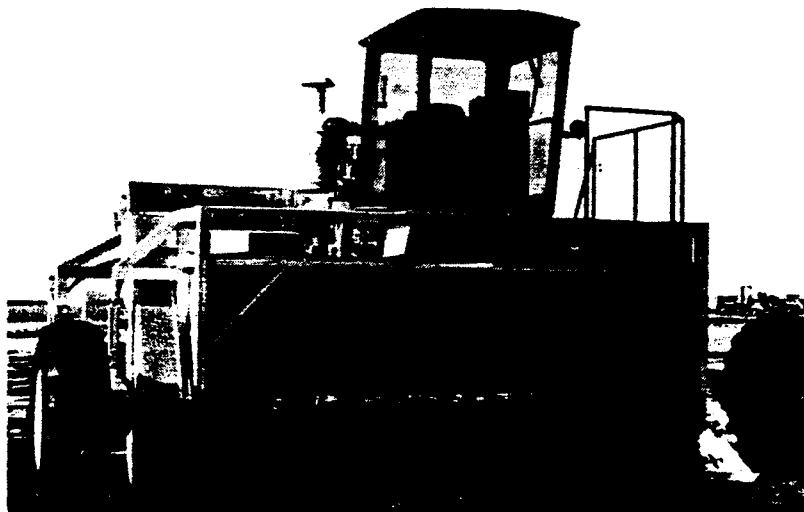

K-W Model 614

STANDARD SPECIFICATIONS: ALL MODELS

- Engine - Caterpillar 3306T Diesel, 300 h.p. or Caterpillar 3406T Diesel, 440 h.p.
- Tunnel - Height adjustment of 17" front & 12" rear.
Polyethylene lined to reduce sticking.
- Drum - Diameter - 16 inches Thickness - 1/2 inch steel
Speed - 800 r.p.m. Shaft - 3 7/16" stress proof, runs full length of drum, center support.
- Flails - Fixed, attached with bolt, hard surfaced.
- Tire Size - Front - 18.4 x 26 or 23.1 x 26 or 28L x 26
Rear - 11L x 15 or 12.5L x 15 or 16.1 x 16.5
- Wheel Drive - Dual hydrostatic, wheel driven by planetary gear. Speeds of 0-4 mph forward and reverse. Automatic load control.
- Cab - Deluxe. McLoughlin Body Works cab. Dimensions 4'x4'x5' with heater, air conditioner, tinted glass, defrost, windshield wipers, radio, high back cushion seat, tilt steering console. Meets OSHA requirements. Extra 1/4" steel plate under cab.
- Lights - Four forward and two rear.
- Warranty - OEM warranty for Caterpillar engine for 2 years. Parts and labor for 1 year.
- Options - Belt or hydraulic drum drive on all models. Tunnel height and width modifications. Fire extinguisher system.

K COMPOST EQUIPMENT

Contact:
LES KUHLMAN, Ph. D.
RESOURCE RECOVERY SYSTEMS
OF NEBRASKA, INC.

Route 4, Sterling, Colo. 80751
Phone: (303) 522-0663
FAX: (303) 522-3387

Clamshell Ends

The tables and figures on these three pages present three series of System 50 Clamshelters fitted with Clamshell ends.

Buildings with two Clamshell ends are designated CC in the model number.

These standard configurations meet most building codes for wind and snow. All arches are constructed from multiples of the two straight beams and the curve, and the purlins define the standard bays between arches.

Longer buildings are available within the standard range by simply increasing the number of bays. Each bay is 12½ feet (3.8 meters) long, and the building length will increase by this additional number of bays.

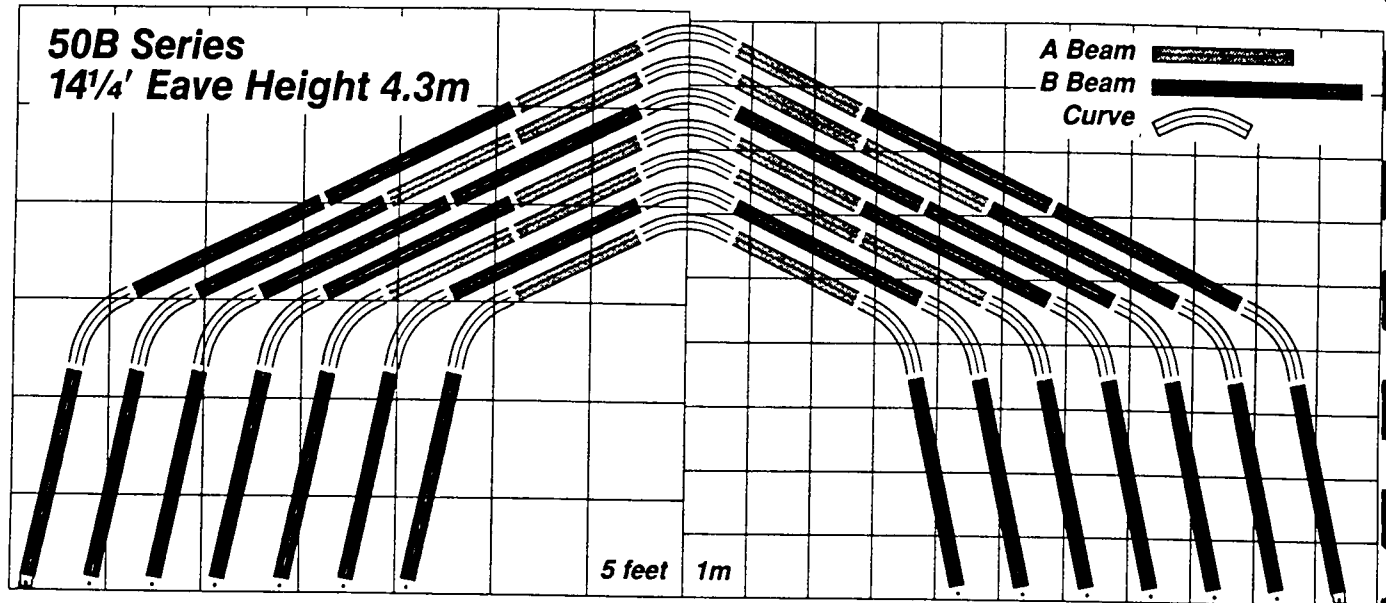

Overall Width		Overall Length & Clamshelter™ Model Number										Overall Height			
FT	M	4 BAYS		5 BAYS		6 BAYS		7 BAYS		8 BAYS		ADDITIONAL BAYS		FT	M
29½	9.0	93¾	28.5	106¼	32.4	113¾	36.2	131¼	40.0	143¾	43.8	Add 12½' 3.8 m PER BAY	19¾	6.0	
		50B-A-4CC		50B-A-5CC		50B-A-6CC		50B-A-7CC		50B-A-8CC					
36	11.0	97	29.5	109½	33.3	122	37.1	134½	41.0	147	44.8	Add 12½' 3.8 m PER BAY	21¼	6.5	
		50B-B-4CC		50B-B-5CC		50B-B-6CC		50B-B-7CC		50B-B-8CC					
42¾	13.0	100	30.5	112½	34.3	125	38.1	137½	41.9	150	45.7	Add 12½' 3.8 m PER BAY	23	7.0	
		50B-AA-4CC		50B-AA-5CC		50B-AA-6CC		50B-AA-7CC		50B-AA-8CC					
49¾	15.0	103¾	31.5	115¾	35.3	128¾	39.1	140¾	42.9	153¾	46.7	Add 12½' 3.8 m PER BAY	24½	7.5	
		50B-BA-4CC		50B-BA-5CC		50B-BA-6CC		50B-BA-7CC		50B-BA-8CC					
56	17.0	106½	32.5	119	36.3	131½	40.1	144	43.9	156½	47.7	Add 12½' 3.8 m PER BAY	26	8.0	
		50B-BB-4CC		50B-BB-5CC		50B-BB-6CC		50B-BB-7CC		50B-BB-8CC					
62½	19.0	109¾	33.4	122¼	37.3	134¾	41.1	147¼	44.9	159¾	48.7	Add 12½' 3.8 m PER BAY	27¾	8.4	
		50B-BAA-4CC		50B-BAA-5CC		50B-BAA-6CC		50B-BAA-7CC		50B-BAA-8CC					
69	21.0	113	34.4	125½	38.2	138	42.0	150½	45.9	163	49.7	Add 12½' 3.8 m PER BAY	29¼	8.9	
		50B-BBA-4CC		50B-BBA-5CC		50B-BBA-6CC		50B-BBA-7CC		50B-BBA-8CC					

Wider sizes are available. Please consult manufacturer.

Dimensions to nearest ¼ foot or 0.1 meter.



APPENDIX B
MOISTURE MEASUREMENT CALCULATIONS

Table B-1

Moisture Measurement Calculations

Parameter	Abbreviation	Calculation
Wet basis percent moisture	%M	$\frac{\text{(initial weight-dry weight)}}{\text{(initial weight)}}$
Water-holding capacity	WHC	$\frac{\text{(saturated weight-dry weight)}}{\text{(saturated weight)}}$
Percent water-holding capacity	%WHC	$\frac{\%M}{WHC}$
Percent saturation	%SAT	$\frac{\text{(initial weight-dry weight)}}{\text{(saturated weight-dry weight)}}$

APPENDIX C
QA/QC PROCEDURES



QUALITY ASSURANCE/QUALITY CONTROL PROCEDURES

C.1 MILLING AND SPLITTING PROCEDURES

In order to test the efficiency of the cleaning procedures used to clean the Wiley mill between samples and to ensure that no cross-contamination was occurring, a test was conducted at WESTON's Environmental Technology Laboratory in Lionville, Pennsylvania. This test was also conducted in the previous composting optimization project [1]. This procedure was also intended to verify the uniformity of the splitting procedure developed jointly by the United States Geological Survey Office in Denver, CO, USAEC, and WESTON.

The test required the use of two dried contaminated compost samples and two dried uncontaminated compost samples. These four samples were processed by the procedure diagrammed in Figure C-1, and then analyzed for explosives. The results of the TNT analyses are presented below their respective sample identifications in Figure C-1. The results obtained for the other analytes were consistent with the TNT results, and also indicate that the procedure provides excellent homogenization of the samples, and that the cleaning procedure is satisfactorily decontaminating the equipment between samples.

C.2 STATIC TANK THERMOCOUPLES

Prior to the beginning of the seeding study, each of the five thermocouples in each of the four aerated static tanks to be used in the tests were calibrated to ensure that they would provide accurate data during the study. Measurements were taken in both an ice water bath and in boiling water. The results are presented in Table C-1 in which the measurements using a laboratory mercury thermometer are presented for comparison with the thermocouple measurements which were output to the monitor in the trailer by the computerized data acquisition system.

C.3 WINDROW THERMOCOUPLES (LANDFILL PROBES)

Prior to the start of the uncontaminated windrow study, a calibration check was conducted to ensure that the K-type thermocouple landfill probes used to take temperature measurements in the windrows were providing accurate measurements. These probes required the use of a digital thermocouple analyzer to convert the signal from the probe into a readable temperature in degrees Celsius. Two such analyzers were available at the site, and both were calibrated such that in the event that one was broken, the other could be used in its place without the need for recalibrating. The results of this check are presented in Table C-2. One of the analyzers was a K-Type only analyzer and its results are indicated by the letter "a" in Table C-2. The other analyzer had the capacity to be used with J and T-Type probes as well, and its measurements (on the K-Type scale) are indicated by the letter "b" in Table C-2.

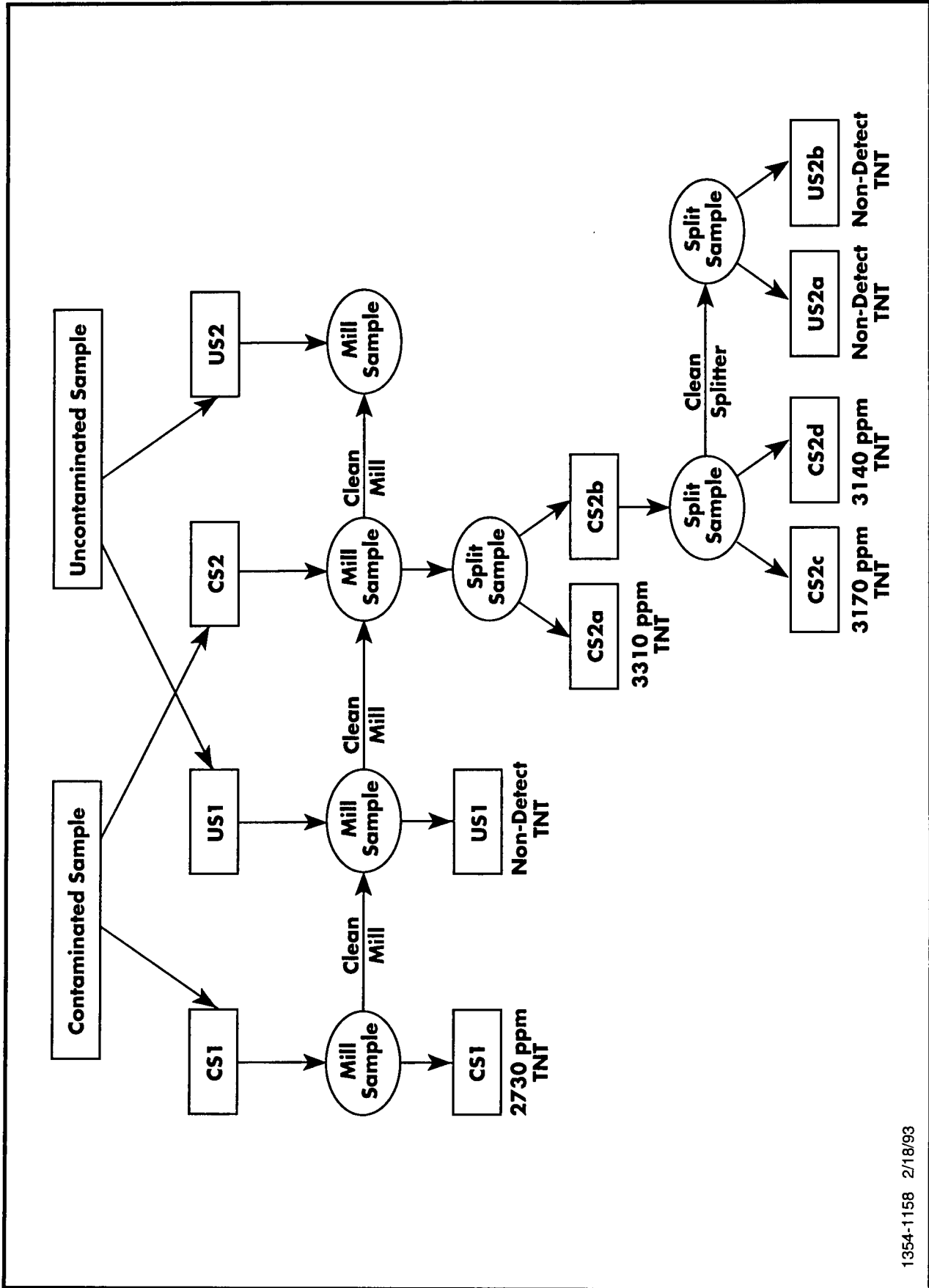

1354-1158 2/18/93

FIGURE C-1 SAMPLE HOMOGENIZATION AND SPLITTING STUDY

Table C-1

Static Tank Thermocouple Calibration

Thermocouple No.	Ice Bath		Boiling Water	
	Mercury Thermometer (°C)	Thermocouple Temp (°C)	Mercury Thermometer (°C)	Thermocouple Temp (°C)
ST-301	0.5	1	99	100
ST-302	0.5	0	99	99
ST-303	0.5	0	99	99
ST-304	0.5	0	99	99
ST-305	0.5	0	99	99
ST-306	0.5	0	99	99
ST-501	0.5	0	99	99
ST-502	0.5	0	99	99
ST-503	0.5	1	99	99
ST-504	0.5	0	99	99
ST-505	0.5	0	99	99
ST-506	0.5	0	99	99
ST-601	0.5	0	99	99
ST-602	0.5	0	99	99
ST-603	0.5	0	99	99
ST-604	0.5	1	99	99
ST-605	0.5	1	99	99
ST-606	0.5	1	99	99
ST-701	0.5	0.5	99	100
ST-702	0.5	0	99	99
ST-703	0.5	0	99	99
ST-704	0.5	0.5	99	100
ST-705	0.5	0	99	99
ST-706	0.5	1	99	100
AA-101	0.5	1	99	99
AA-102	0.5	1	99	100

Table C-2

Landfill Probe Calibration

Probe No.	Boiling Water		Ice Bath	
	Mercury Thermometer (°C)	Probe (°C)	Mercury Thermometer (°C)	Probe (°C)
1a	100	98.8	0	0.4
1b	99.5	98.5	0	0.1
2a	100	98.6	0	0
2b	100	98.6	0	-0.1
3a	99	98.5	0	0.2
3b	99	98.5	0	0.3
4a	99	98.6	0	0.1
4b	99	98.3	0	-0.2
5a	99	97.8	0	0.1
5b	99	97.8	0	-0.1
6a	99	97.8	0	0.1
6b	99	97.4	0	-0.2
7a	99	98.0	0	0.4
7b	99	97.8	0	0.3

a = Indicates K-Only Type Thermocouple Analyzer

b = J, K, T-Type Thermocouple Analyzer

C.4 BECKMAN PH METER AND METTLER BALANCE

A Beckman digital pH meter and a Mettler balance were two instruments used in the laboratory which required calibration before each use. The balance was calibrated by use of a 20 gram standard mass. The weight of this mass as indicated by the balance's digital readout was recorded in the daily calibration logbook to the nearest 0.01 and was generally within .02 g of the actual weight. If the reading was not in this range, the balance was tared and the weight was measured again until it was reading correctly.

The Beckman digital pH meter was calibrated prior to each day's usage. This was accomplished using a series of three pH buffer solutions. The meter was first calibrated to buffer solutions of pH 4 and pH 10 respectively. Afterwards, the pH of a pH 7 buffer solution was measured and recorded in the daily calibration logbook. If the pH meter did not read within +/-0.05 pH units of 7.00, the instrument was recalibrated before taken any sample measurements.

C.5 OXYGEN METER CALIBRATION

To confirm the accuracy of the measurements taken with the oxygen probes, calibration checks were conducted using a cylinder of 1% oxygen in nitrogen supplied by Scott Specialty Gases Inc. Table C-3 presents the data obtained for two separate studies.

Three different types of oxygen analyzers were used throughout the seeding and windrow composting studies and all three were calibrated as part of this study. At the start of testing, two Engineering Systems Designs Model 600 oxygen analyzers were used. An Engineering Systems Designs Model 630 analyzer was obtained during the uncontaminated windrow study in an effort to provide greater sensitivity and stability at low oxygen levels. Finally a Burrell Industrial Gas (ORSAT) Analyzer was provided as an additional check on the accuracy of the direct reading instruments.

Typical daily calibration of the direct reading instruments was conducted in air according to manufacturer's instructions. In addition, efforts were made to assess the performance of each device at low oxygen concentrations, due to the low observed interstitial oxygen levels in the windrow tests. The two Model-600 analyzers were identical and their accompanying probes were interchangeable. As a result, all four possible analyzer/probe combinations were checked to assure the accuracy of their measurements. The Model 630 and its probe were specifically designed to be used together. The final row in Table C-3 gives the results achieved with the Burrell Industrial Gas Analyzer.

In addition to these checks, the Model 6763-1 probe was returned to the manufacturer for testing. The manufacturer reported a reading of 0.3% oxygen in pure nitrogen gas.

Based upon these results, it appears that the direct reading instruments used in this study provide accurate oxygen readings down to approximately 1% by volume. Below that level readings may be inaccurate. Some of the inaccuracy may result from the sensor itself and some from unavoidable or undetectable leaks in the sample probe.

Table C-3

Results of Oxygen Meter Calibration Studies

Analysis Method	Probe Number	Ambient Air (%O ₂)	Scott Specialty Gas (1.0% O ₂)	
			Trial No. 1 (%O ₂)	Trial No. 2 (%O ₂)
Model 600a	6763-1	20.9	1.2	1.2
Model 600a	6718-1	20.9	1.3	1.2
Model 600b	6763-1	20.9	1.1	1.3
Model 600b	6718-1	20.9	1.2	1.3
Model 630	285	20.9	1.6	not tested
Burrell Industrial Gas Analyzer		20.9	1.4	0.8, 0.7, 0.6 (3 replicates)



APPENDIX D

ANALYTICAL PROCEDURES

**USATHAMA Method LW02
EPA Draft Method 1312**

Analytical Method for Analysis of Intermediates

EXPLOSIVES IN SOIL

I. SUMMARY

A. Analytes:

HMX	Octahydro-1,3,5,7-tetranitro-1,3,5,7-tetrazocine
RDX	Hexahydro-1,3,5-trinitro-s-triazine
NB	Nitrobenzene
1,3-DNB	1,3-Dinitrobenzene
1,3,5-TNB	1,3,5-Trinitrobenzene
2,4-DNT	2,4-Dinitrotoluene
2,6-DNT	2,6-Dinitrotoluene
2,4,6-TNT	2,4,6-Trinitrotoluene
Tetryl	2,4,6-Trinitrophenylmethylnitramine

B. Matrix: Soil or sediment

C. General Method: An aliquot of soil is extracted with acetonitrile. The acetonitrile is diluted with methanol and water, and the resultant solution is injected onto the HPLC for analysis.

II. APPLICATION

A. Tested Concentration Range:

HMX	1.27-140 ug/g
RDX	0.98- 80.0 ug/g
NB	0.42- 60.0 ug/g
1,3-DNB	0.59- 60.0 ug/g
1,3,5-TNB	2.09- 60.0 ug/g
2,4-DNT	0.42- 60.0 ug/g
2,6-DNT	0.40- 60.0 ug/g
2,4,6-TNT	1.92-100.0 ug/g
Tetryl	0.32- 24.9 ug/g

B. Sensitivity:

Peak Height in mm at an Attenuation of 2^4

HMX	48 mm for 14 ug/g
RDX	48 mm for 8.0 ug/g
NB	26 mm for 6.0 ug/g
1,3-DNB	53 mm for 6.0 ug/g
1,3,5-TNB	44 mm for 6.0 ug/g
2,4-DNT	31 mm for 10.0 ug/g
2,6-DNT	17 mm for 6.0 ug/g
2,4,6-TNT	45 mm for 6.0 ug/g
Tetryl	26 mm for 8.0 ug/g

C. Detection Limits:

HMX	1.27 ug/g
RDX	0.98 ug/g
NB	0.42 ug/g
1,3-DNB	0.59 ug/g
1,3,5-TNB	2.09 ug/g
2,4-DNT	0.42 ug/g
2,6-DNT	0.40 ug/g
2,4,6-TNT	1.92 ug/g
Tetryl	0.32 ug/g

D. Interferences:

1. Any compound that is extracted from soil that gives a retention time similar to the nitro-compounds and absorbs at 250 nm.

E. Analysis Rate:

After instrument calibration, one analyst can analyze two samples in one hour. One analyst can conduct sample preparation at a rate of three samples per hour. One analyst doing both sample preparation and the HPLC analysis can run 16 samples in an 8-hour day.

F. Safety information:

Work in well-ventilated areas. Wear adequate protective clothing to avoid skin contact. Wash skin with soap and water thoroughly immediately after contact.

TNB, HMX, RDX, Tetryl, and TNT's are classified as Explosives A by DOT. Avoid extreme temperatures and pressures.

III. APPARATUS AND CHEMICALS

A. Glassware/Hardware

1. Syringes: 10 uL, 50 uL, 100 uL, 1 mL syringe (Hamilton 1005 TEFL)
2. Vials with Teflon-lined caps or septa. Nominal volume of 1.8 mL, 4.0 mL and 8.0 mL.
3. B-D Glaspak disposable syringes, 5 mLs, with frosted tip
4. 0.2 micron fluorocarbon filters
5. Micropipettes, 200 uL
6. Hypo needles
7. 2 mL. pipette

B. Instrumentation

1. Perkin-Elmer Series 4 High Performance Liquid Chromatograph (HPLC) equipped with a Perkin-Elmer ISS100 Auto-Injector and Micromeritics Model 786 UV/VIS variable wavelength detector. Hewlett-Packard 3390 recording integrator in peak height mode was used to record data output. ISS 100 auto injector is equipped with a temperature controlled sample tray to refrigerate extracts.
2. Analytical Balance

Capable of weighing 0.01 grams for sample preparation and 0.1 mg for standard preparation. Mettler AE 163 or equivalent.
3. Parameters
 - a. Columns:
 - 1) DuPont Zorbax^R C-8 4.6 mm i.d. x 25 cm HPLC column with a particle size of 5-6 microns.
 - 2) DuPont Permaphase^R ODS guard column. (optional)

- b. Mobile Phase: The water/methanol ratio must be adjusted as described in the calibration Section V.A.5.c to obtain optimum peak separation.

52% methanol

48% water

- c. Flow: 1.6 mL/min with a pressure of approximately 2860 psig.

- d. Detector: 250 nm

- e. Injection Volume: 50 uL

- f. Retention Times:

	<u>Minutes</u>
HMX	3.30- 3.60
RDX	4.55- 4.70
NB	7.95- 9.00
1,3-DNB	7.30- 8.00
1,3,5-TNB	6.35- 6.40
2,4-DNT	11.00-13.10
2,6-DNT	10.60-12.40
2,4,6-TNT	10.05-10.90
Tetryl	9.15- 9.70

C. Analytes

1. Chemical Abstracts Registry Numbers

HMX	2691-41-0
RDX	121-82-4
NB	98-95-3
1,3-DNB	99-65-01
1,3,5-TNB	99-35-4
2,4-DNT	121-14-2
2,6-DNT	606-20-2
2,4,6-TNT	118-96-7
Tetryl	35572-78-2

2. Chemical Reactions

- a. RDX and HMX can undergo alkaline hydrolysis.
- b. RDX and HMX degrade at temperatures greater than 80_C in an organic solvent.

3. Physical Properties

	<u>Formula</u>	<u>Mol. Wt.</u>	<u>M.P. (°C)</u>	<u>B.P. (°C)</u>
HMX	$C_4H_8N_8O_8$	296.6	276	-
RDX	$C_3H_6N_6O_6$	222.12	205	-
NB	$C_6H_5NO_2$	123.11	6	211
1,3-DNB	$C_6H_4N_2O_4$	168.11	90	302
1,3,5-TNB	$C_6H_3N_3O_6$	213.11	122	315
2,4-DNT	$C_7H_6N_2O_4$	182.14	71	300 (decomposes)
2,6-DNT	$C_7H_6N_2O_4$	182.14	66	-
2,4,6-TNT	$C_7H_5N_3O_6$	227.13	82	240 (decomposes)
Tetryl	$C_7H_5N_5O_8$	287.15	131	187

D. Reagents and SARMs:

1. Acetonitrile, distilled in glass for HPLC use
2. Methanol, distilled in glass for HPLC use
3. Water, distilled in glass for HPLC use
4. USATHAMA Standard Soil
5. SARMs

HMX SARM No.	1217 (PA 1303)
RDX SARM No.	1130 (PA 1302)
NB SARM No.	(PA 1306)
1,3-DNB SARM No.	2250 (PA 1305)
1,3,5-TNB SARM No.	1154 (PA 1300)
2,4-DNT SARM No.	1147 (PA 1298)
2,6-DNT SARM No.	1148 (PA 1299)
2,4,6-TNT SARM No.	1129 (PA 1297)
Tetryl SARM No.	1149 (PA 1301)

IV. CALIBRATION

A. Initial Calibration

1. Preparation of Standards:

a. Stock calibration solutions containing approximately 10,000 mg/L of a nitro-compound are prepared by accurately weighing ca. 50 mg of a SARM into a 5 mL serum bottle and dissolving the nitro-compound in 5 mL of acetonitrile pipetted into the bottle. All stock solutions prepared in this manner and stored in a freezer (0°C to -4°C) have remained stable for a period of 6 months.

b. Intermediate Calibration Standards: All compounds appear to be stable for at least 3 months.

1) Intermediate Calibration Standard A (high level): Combine the appropriate volumes of stock calibration standard as shown below. Dilute to 5 mL with acetonitrile and seal with a Teflon-lined cap. Store in the dark at 0°C-4°C. The resulting solution will have the concentrations indicated in the following table.

<u>Nitro-compound</u>	<u>uL of Stock Cal Std</u>	<u>Resulting concentration (ug/mL)</u>
HMX	175	350
RDX	100	200
NB	75	150
1,3-DNB	75	150
1,3,5-TNB	75	150
2,4-DNT	75	150
2,6-DNT	75	150
2,4,6-TNT	125	250
Tetryl	100	200

- 2) Intermediate Calibration Standard B (low level): 1:10 dilution of the Intermediate Calibration Standard A is made in Acetonitrile. Seal with a Teflon-lined cap and store in the dark at 0^o-4^oC. The resulting solution will have the following concentrations:

<u>Nitro-Compound</u>	<u>Resulting conc.</u> <u>(ug/mL)</u>
HMX	35.0
RDX	20.0
NB	15.0
1,3-DNB	15.0
1,3,5-TNB	15.0
2,4-DNT	15.0
2,6-DNT	15.0
2,4,6-TNT	25.0
Tetryl	20.0

- c. Working Calibration Standards: Using the following table, prepare a series of ten calibration standards. Place the mobile phase into a 1-mL serum vial. Inject the indicated volumes of intermediate calibration standard A or B into the acetonitrile with a microliter syringe. Seal the vial with a teflon-lined septum and cap. Mix well. These solutions are prepared fresh daily and kept in the dark.

WORKING CALIBRATION STANDARDS

Conc.	Amt. (uL) Intermed. Cal. Std. to Add		Amt. (uL) Mobile Phase to Add	Resulting Concentration (ug/L)			
	A	B		HMX	2,4,6- TNT	Tetryl RDX	1,3-DNB 1,3,5-TNB 2,6-DNT 2,4-DNT
0	0	0	2.0	-	-	-	-
0.2 X	-	1.0	999.0	35	25	20	15
0.5 X	-	2.5	997.5	87.5	62.5	50	37.5
1 X	-	5	995.0	175	125	100	75
2 X	-	10	990.0	350	250	200	150
5 X	-	25	975.0	875	625	500	375
10 X	5	-	995.0	1750	1250	1000	750
20 X	10	-	990.0	3500	2500	2500	1500
50 X	25	-	975.0	8750	6250	5000	3750
100 X	50	-	950.0	17500	12500	10000	7500

2. Instrument Calibration

- a. Set up the instrument according to the manufacturer's recommendations.
- b. Mobile Phase is analyzed as a blank to verify a stable baseline.
- c. Analyze the medium calibration standard (10X) to verify peak separation and retention times.
- d. Analyze the calibration standards prepared in Section IV.A.1.

3. Analysis of Calibration Data

- a. Tabulate the calibration standard concentration versus the peak height response for each calibration standard.
- b. Perform a linear regression analysis on the calibration data plotting peak height vs. concentration in ug/l.

4. Calibration Checks

- a. After completion of analyses of samples, a calibration standard at the highest concentration is analyzed. The response must agree within 25% for that concentration from the first seven calibration curves. Thereafter, the response must agree within two standard deviations of the mean response for that concentration. If it does not, the calibration standard will be reanalyzed. If the calibration standard fails this test, initial calibration must be performed, and all samples analyzed since the last acceptable calibration must be reanalyzed.
- b. No certified calibration check standards are available for these compounds.

B. Daily Calibration

1. Prior to analyses each day, a high calibration standard will be analyzed. For the first seven determinations at this concentration, the response must agree within 25% of the mean of all previous responses. After seven determinations, the response must agree within +/- two standard deviations of the mean response for previous determinations at this concentration.

2. If the calibration standard fails this test, it will be reanalyzed. If the calibration standard fails the second test, the system will have failed daily calibration, and initial calibration will be performed.
3. After completion of sample analyses each day, the high calibration standard will be analyzed again. The response for this calibration standard will be subjected to the criteria discussed in Section IV.B.1, above. If the response fails the criteria, the standard will be reanalyzed. If the second response fails the test, the system will have failed calibration, and initial calibration will be performed. All samples analyzed since the last acceptable calibration must be reanalyzed.

V. Certification Testing

A. Control Spikes:

To a series of ten 5-mL serum vials, approximately one gram of soil is accurately weighed into each vial. Using a syringe, the volumes of intermediate calibration standard indicated in the following table are injected onto the soil. The serum vial is covered with a septum and shaken until the soil no longer looks wet (approximately 60 seconds). The sample must equilibrate at least one hour. The septum is removed and the indicated amount (see Table below) of acetonitrile is pipetted onto the soil. The septum is replaced and the vial is capped. The sealed sample is shaken by hand for approximately 2-3 minutes. The sample is prepared via the procedure given in this method, to give the target concentrations in the following table.

CONTROL SPIKES

Conc.	Amt. (uL)		Amt. (uL) Aceto Nitrile to Add	Resulting Concentration (ug/g)			
	Intermed. Cal. Std.			HMX	2,4,6 TNT	Tetryl RDX	1,3-DNB 1,3,5-TNB 2,6-DNT 2,6-DNT NB
	to Add A	B					
0	0	0	2000	0	0	0	0
0.2 X	-	8.0	1992	0.28	0.2	0.16	0.12
0.5 X	-	20	1980	0.70	0.5	0.4	0.3
1 X	4	-	1996	1.40	1.0	0.8	0.6
2 X	8	-	1992	2.80	2.0	1.6	1.2
5 X	20	-	1980	7.0	5.0	4.0	3.0
10 X	40	-	1960	14.0	10.0	8.0	6.0
20 X	80	-	1920	28.0	20.0	16.0	12.0
50 X	200	-	1800	70.0	50.0	40.0	30.0
100 X	400	-	1600	140.0	100.0	80.0	60.0

VI. SAMPLE HANDLING STORAGE

- A. Sampling Procedure: The stability of explosives in soil is not truly known. Precautions should be taken to avoid prolonged exposure to light and heat.
- B. Containers: Wide-mouth amber glass bottles with teflon-lined lids.
- C. Storage Conditions: Samples should be maintained at 4 C from the time of collection to the time of analysis. No chemical preservatives are necessary.
- D. Holding Time Limits: 7 days to extraction; 40 days to analysis from the time of extraction.
- E. Solution Verification: No certified check standards are available.

VII. PROCEDURE

A. Separations

1. Accurately weigh 1 gram of soil into a 5-mL serum vial and pipette 4 mL of acetonitrile onto the soil.

2. Place a septum and cap on the vial and shake the vial thoroughly by hand for 2-3 minutes.
3. The extract is then filtered using the following technique.

A 5-mL syringe is fitted with a needle. After the extract is drawn into the syringe barrel, a Fluorocarbon 0.2 micron disposable filter is attached in place of the needle. The sample is then slowly forced through the filter into a 4.0 mL teflon capped vial and stored until the extract is diluted and analyzed by HPLC. (Step 4-C.)

4. Preparation of sample extracts and spikes for injection is performed the day of analysis.
 - a. Using a disposable micropipette, accurately measure 200 uL of filtered extract into a 1-mL vial. Accurately measure 600 uL of a 33% methanol/67% water solution onto the filtered sample. This will produce 800 uL of extracted sample in mobile phase.
 - b. Place a septum cap on the vial. Shake the vial well to thoroughly mix. Store in the dark at 0^o-4^o C until ready to analyze.
- B. Chemical Reactions - None. Compounds are read directly.
- C. Instrumental Analysis:
1. Set the chromatographic conditions as follows:

	Time (minutes)	Flow (mLs/min.)	MeCN %	MeOH %	HOH %
Equilibrium	2	1.6	16	34	50
Analysis Run	20	1.6	16	34	50

2. All standards and extracts should be in chilled tray (4^o C)
3. Using the auto-injector manufacturer's recommended procedure, introduce 50 uL of the medium level calibration standard into the

chromatographic system. Check the chromatogram to ensure separation of the nitrated toluenes and separation of the nitrobenzene and tetryl. If necessary, adjust the water/ methanol ratio of the mobile phase until separate peaks are distinguished. As the column ages, less methanol is required. Generally, the column ages rapidly the first 24 hours, after which it is fairly stable.

- 4) Once good peak separation is obtained, introduce 50 uL of each working calibration standard and sample into the chromatographic system using the auto-injector manufacturer's recommended procedure.

VIII. CALCULATIONS

- A. The diluted extract concentration is read or calculated from the instrument calibration curve.
- B. Sample Concentration (ug/g) = extract conc $\times \frac{B \times D}{A \times C}$

where:

- A = sample weight (dry weight)
- B = mL acetonitrile used to extract sample
- C = mL acetonitrile extract diluted into mobile phase
- D = final volume in mL of mobile phase prepared for injection

NOTE: When samples are prepared according to this method (1 gram extracted into 8 mL of mobile phase), the above calculation becomes:

$$\text{Sample Concentration (ug/g)} = \text{extract conc (ug/l)} \times 0.008$$

IX. DAILY QUALITY CONTROL

A. Control Samples

1. Intermediate Spiking Standard A and B are made according to Section IV just as calibration standards.

2. Daily control samples are prepared in a manner identical to that described in Section V. A total of three control spikes are required on a daily basis: two at 10X and one at 2X. They will have the following concentrations.

Conc.	Amt (uL) Intermed. Spiking A to add to 2.0 mls					
	Acetonitrile	HMX	2,4,6-TNT	Tetryl RDX	2,4-DNT	2,6-DNT 1,3-DNB 1,3,5-TNB NB
2X	8	2.8	2.0	1.6	1.2	
10X	40	14.0	10.0	8.0	6.0	

3. At least one method blank using the USATHAMA Standard Soil is also analyzed with each analytical lot.
4. At least one matrix spike (actual sample) at 10X is analyzed for each analytical lot or at a frequency of 10%, whichever is more frequent.

B. Control Charts:

1. Average Percent Recovery (X)

- Percent recoveries for the 10X certification spikes from days 1 and 2 are averaged to obtain the first value to be plotted.
- Percent recoveries for the 10X certification spikes from days 3 and 4 are averaged to obtain the second value to be plotted.
- Percent recoveries for the method spikes closest to the certification 10X concentration from the first day of analyses are averaged to obtain the third value to be plotted.
- Values from a, b, and c are averaged to determine the central line of the control chart.
- Differences in percent recoveries for each pair of values in a, b, and c are averaged to obtain R.
- The upper and lower warning limits are $\pm 1.25 R$ from the central line.

g. The upper and lower control limits are $\pm 1.88 R$ from the central line.

2. Difference in percent recoveries (R)

a. The value for R obtained in Section IX.B.1.e, above, is the base line of the control chart.

b. The warning limit is $2.511 R$.

c. The control limit is $3.267 R$.

3. Three Point Moving Average X

a. The average percent recovery from the 5 ug/g concentration from the first three days of certification testing is the first point to be plotted.

b. Subsequent points to be plotted are the average percent recoveries from the 5 ug/g concentration from the next group of three determinations (e.g., certification days 2, 3, and 4; certification days 3 and 4 and the first day of analysis; certification day 4, day 1 of analysis, and day 2 of analysis; etc.)

c. The central point on the control chart is the average of the plotted points and changes with each added point.

d. The range for each point is the difference between the highest and lowest values in each group of three determinations. The average range (MAR) is used to define the warning and control limits.

e. The upper and lower warning limits are $\pm 0.682 \text{ MAR}$, respectively.

f. The upper and lower control limits are $\pm 1.023 \text{ MAR}$, respectively.

4. Three point Moving Average R:

a. The base line is the MAR.

b. The warning limit is 2.050 MAR .

c. The control limit is 2.575 MAR .

5. Certified Calibration Check Standard:

- a. If available, two certified calibration check standards are analyzed with samples.
- b. For the first 20 determinations, results must fall within the acceptable range specified by the source of the standard.
- c. After 20 determinations, the mean value of the 20 determinations is used as the central line of a control chart.
- d. Warning limits are +/- two standard deviations.
- e. Control limits are +/- three standard deviations.

X. REFERENCES

- A. USATHAMA Method 2C Cyclotrimethylenetrinitramine (RDX) in Soil and Sediment Samples, 12-3-80.
- B. USATHAMA Method 8H Explosives in Water by HPLC, 12-27-82.

XI. DATA

A. Off-the-Shelf Analytical Reference Materials
Characterization: Not Applicable

B. Initial Calibration

1. Response versus concentration data: See attached.
2. Response versus concentration graphs: See attached.
3. LOF Tests: Not applicable.
4. ZI Tests: Not applicable.

C. Daily Calibration

1. Response: Not applicable.
2. Required percentage or two standard deviation limits: Not applicable.

D. Standard Certification Samples

1. Tabulation and graph of found versus target concentrations: See attached.
2. LOF and ZI tests for the pooled data: See attached.
3. Calculated least squares linear regression line, confidence bounds, reporting limit, accuracy, standard deviation, percent imprecision, and percent inaccuracy: See attached.
4. Chromatograms: Attached

METHOD 1312

SYNTHETIC PRECIPITATION LEACHING PROCEDURE

1.0 SCOPE AND APPLICATION

1.1 Method 1312 is designed to determine the mobility of both organic and inorganic analytes present in samples of soils, wastes, and wastewaters.

1.2 If a total analysis of the soil, waste, or wastewater demonstrates that individual analytes are not present, or that they are present but at such low concentrations that the appropriate regulatory levels could not possibly be exceeded, Method 1312 need not be run.

1.3 If an analysis of any one of the liquid fractions of the 1312 extract indicates that a regulated compound is present at such high concentrations that, even after accounting for dilution from the other fractions of the extract, the concentration would be above the regulatory level for that compound, then the waste is hazardous and it is not necessary to analyze the remaining fractions of the extract.

1.4 If an analysis of extract obtained using a bottle extractor shows that the concentration of any regulated volatile analyte exceeds the regulatory level for that compound, then the waste is hazardous and extraction using the ZHE is not necessary. However, extract from a bottle extractor cannot be used to demonstrate that the concentration of volatile compounds is below the regulatory level.

2.0 SUMMARY OF METHOD

2.1 For liquid samples (*i.e.*, those containing less than 0.5 percent dry solid material), the sample, after filtration through a 0.6 to 0.8 μm glass fiber filter, is defined as the 1312 extract.

2.2 For samples containing greater than 0.5 percent solids, the liquid phase, if any, is separated from the solid phase and stored for later analysis; the particle size of the solid phase is reduced, if necessary. The solid phase is extracted with an amount of extraction fluid equal to 20 times the weight of the solid phase. The extraction fluid employed is a function of the region of the country where the sample site is located if the sample is a soil. If the sample is a waste or wastewater, the extraction fluid employed is a pH 4.2 solution. A special extractor vessel is used when testing for volatile analytes (see Table 1 for a list of volatile compounds). Following extraction, the liquid extract is separated from the sample by 0.6 to 0.8 μm glass fiber filter.

2.3 If compatible (*i.e.*, multiple phases will not form on combination), the initial liquid phase of the waste is added to the liquid extract, and these are analyzed together. If incompatible, the liquids are analyzed separately and the results are mathematically combined to yield a volume-weighted average concentration.

3.0 INTERFERENCES

3.1 Potential interferences that may be encountered during analysis are discussed in the individual analytical methods.

4.0 APPARATUS AND MATERIALS

4.1 Agitation apparatus: The agitation apparatus must be capable of rotating the extraction vessel in an end-over-end fashion (see Figure 1) at 30 ± 2 rpm. Suitable devices known to EPA are identified in Table 2.

4.2 Extraction Vessels

4.2.1 Zero Headspace Extraction Vessel (ZHE). This device is for use only when the sample is being tested for the mobility of volatile analytes (i.e., those listed in Table 1). The ZHE (depicted in Figure 2) allows for liquid/solid separation within the device and effectively precludes headspace. This type of vessel allows for initial liquid/solid separation, extraction, and final extract filtration without opening the vessel (see Step 4.3.1). These vessels shall have an internal volume of 500-600 mL and be equipped to accommodate a 90-110 mm filter. The devices contain VITON[®] O-rings which should be replaced frequently. Suitable ZHE devices known to EPA are identified in Table 3.

For the ZHE to be acceptable for use, the piston within the ZHE should be able to be moved with approximately 15 psi or less. If it takes more pressure to move the piston, the O-rings in the device should be replaced. If this does not solve the problem, the ZHE is unacceptable for 1312 analyses and the manufacturer should be contacted.

The ZHE should be checked for leaks after every extraction. If the device contains a built-in pressure gauge, pressurize the device to 50 psi, allow it to stand unattended for 1 hour, and recheck the pressure. If the device does not have a built-in pressure gauge, pressurize the device to 50 psi, submerge it in water, and check for the presence of air bubbles escaping from any of the fittings. If pressure is lost, check all fittings and inspect and replace O-rings, if necessary. Retest the device. If leakage problems cannot be solved, the manufacturer should be contacted.

Some ZHEs use gas pressure to actuate the ZHE piston, while others use mechanical pressure (see Table 3). Whereas the volatiles procedure (see Step 7.3) refers to pounds-per-square-inch (psi), for the mechanically actuated piston, the pressure applied is measured in torque-inch-pounds. Refer to the manufacturer's instructions as to the proper conversion.

4.2.2 Bottle Extraction Vessel. When the sample is being evaluated using the nonvolatile extraction, a jar with sufficient capacity to hold the sample and the extraction fluid is needed. Headspace is allowed in this vessel.

¹VITON[®] is a trademark of Du Pont.

The extraction bottles may be constructed from various materials, depending on the analytes to be analyzed and the nature of the waste (see Step 4.3.3). It is recommended that borosilicate glass bottles be used instead of other types of glass, especially when inorganics are of concern. Plastic bottles, other than polytetrafluoroethylene, shall not be used if organics are to be investigated. Bottles are available from a number of laboratory suppliers. When this type of extraction vessel is used, the filtration device discussed in Step 4.3.2 is used for initial liquid/solid separation and final extract filtration.

4.3 Filtration Devices: It is recommended that all filtrations be performed in a hood.

4.3.1 Zero-Headspace Extraction Vessel (ZHE): When the sample is evaluated for volatiles, the zero-headspace extraction vessel described in Step 4.2.1 is used for filtration. The device shall be capable of supporting and keeping in place the glass fiber filter and be able to withstand the pressure needed to accomplish separation (50 psi).

NOTE: When it is suspected that the glass fiber filter has been ruptured, an in-line glass fiber filter may be used to filter the material within the ZHE.

4.3.2 Filter Holder: When the sample is evaluated for other than volatile analytes, a filter holder capable of supporting a glass fiber filter and able to withstand the pressure needed to accomplish separation may be used. Suitable filter holders range from simple vacuum units to relatively complex systems capable of exerting pressures of up to 50 psi or more. The type of filter holder used depends on the properties of the material to be filtered (see Step 4.3.3). These devices shall have a minimum internal volume of 300 mL and be equipped to accommodate a minimum filter size of 47 mm (filter holders having an internal capacity of 1.5 L or greater, and equipped to accommodate a 142 mm diameter filter, are recommended). Vacuum filtration can only be used for wastes with low solids content (<10 percent) and for highly granular, liquid-containing wastes. All other types of wastes should be filtered using positive pressure filtration. Suitable filter holders known to EPA are shown in Table 4.

4.3.3 Materials of Construction: Extraction vessels and filtration devices shall be made of inert materials which will not leach or absorb sample components. Glass, polytetrafluoroethylene (PTFE), or type 316 stainless steel equipment may be used when evaluating the mobility of both organic and inorganic components. Devices made of high-density polyethylene (HDPE), polypropylene (PP), or polyvinyl chloride (PVC) may be used only when evaluating the mobility of metals. Borosilicate glass bottles are recommended for use over other types of glass bottles, especially when inorganics are analytes of concern.

4.4 Filters: Filters shall be made of borosilicate glass fiber, shall contain no binder materials, and shall have an effective pore size of 0.6 to 0.8- μ m or equivalent. Filters known to EPA which meet these specifications are identified in Table 5. Pre-filters must not be used. When evaluating the mobility of metals, filters shall be acid-washed prior to use by rinsing with 1N

nitric acid followed by three consecutive rinses with deionized distilled water (a minimum of 1-L per rinse is recommended). Glass fiber filters are fragile and should be handled with care.

4.5 pH Meters: The meter should be accurate to ± 0.05 units at 25°C.

4.6 ZHE Extract Collection Devices: TEDLAR² bags or glass, stainless steel or PTFE gas-tight syringes are used to collect the initial liquid phase and the final extract when using the ZHE device. These devices listed are recommended for use under the following conditions:

4.6.1 If a waste contains an aqueous liquid phase or if a waste does not contain a significant amount of nonaqueous liquid (i.e., <1 percent of total waste), the TEDLAR² bag or a 600 mL syringe should be used to collect and combine the initial liquid and solid extract.

4.6.2 If a waste contains a significant amount of nonaqueous liquid in the initial liquid phase (i.e., >1 percent of total waste), the syringe or the TEDLAR² bag may be used for both the initial solid/liquid separation and the final extract filtration. However, analysts should use one or the other, not both.

4.6.3 If the waste contains no initial liquid phase (is 100 percent solid) or has no significant solid phase (is 100 percent liquid), either the TEDLAR² bag or the syringe may be used. If the syringe is used, discard the first 5 mL of liquid expressed from the device. The remaining aliquots are used for analysis.

4.7 ZHE Extraction Fluid Transfer Devices: Any device capable of transferring the extraction fluid into the ZHE without changing the nature of the extraction fluid is acceptable (e.g., a positive displacement or peristaltic pump, a gas-tight syringe, pressure filtration unit (see Step 4.3.2), or other ZHE device).

4.8 Laboratory Balance: Any laboratory balance accurate to within ± 0.01 grams may be used (all weight measurements are to be within ± 0.1 grams).

4.9 Beaker or Erlenmeyer flask, glass, 500 mL.

4.10 Watchglass, appropriate diameter to cover beaker or Erlenmeyer flask.

4.11 Magnetic stirrer.

5.0 REAGENTS

5.1 Reagent grade chemicals shall be used in all tests. Unless otherwise indicated, it is intended that all reagents shall conform to the specifications of the Committee on Analytical Reagents of the American Chemical Society, where such specifications are available. Other grades may be used,

²TEDLAR² is a registered trademark of Du Pont.

provided it is first ascertained that the reagent is of sufficiently high purity to permit its use without lessening the accuracy of the determination.

5.2 Reagent water. All references to reagent water in this method refer to one of the following, as appropriate.

5.2.1 Inorganic Analytes: Water which is generated by any method which would achieve the performance standards for ASTM Type II water. The analyte(s) of concern must be no higher than the highest of either (1) the detection limit, or (2) five percent of the regulatory level for that analyte, or (3) five percent of the measured concentration in the sample.

5.2.2 Volatile Analytes: Water in which an interferant is not observed at the method detection limit of the compounds of interest. Organic-free water can be generated by passing tap water through a carbon filter bed containing about 1 lb. of activated carbon. A water purification system may be used to generate organic-free deionized water. Organic-free water may also be prepared by boiling water for 15 minutes. Subsequently, while maintaining the temperature at 90°C, bubble a contaminant-free inert gas through the water for 1 hour. The analyte(s) of concern must be no higher than the highest of either (1) the detection limit, or (2) five percent of the regulatory level for that analyte, or (3) five percent of the measured concentration in the sample.

5.2.3 Semivolatile Analytes: Water in which an interferant is not observed at the method detection limit of the compounds of interest. Organic-free water can be generated by passing tap water through a carbon filter bed containing about 1 lb. of activated carbon. A water purification system may be used to generate organic-free deionized water. The analyte(s) of concern must be no higher than the highest of either (1) the detection limit, or (2) five percent of the regulatory level for that analyte, or (3) five percent of the measured concentration in the sample.

5.3 Sulfuric acid/nitric acid (60/40 weight percent mixture) H_2SO_4/HNO_3 . Cautiously mix 60 g of concentrated sulfuric acid with 40 g of concentrated nitric acid.

5.4 Extraction fluids.

5.4.1 Extraction fluid #1: This fluid is made by adding the 60/40 weight percent mixture of sulfuric and nitric acids to reagent water (Step 5.2) until the pH is 4.20 ± 0.05 . The fluid is used to determine the leachability of soil from a site that is east of the Mississippi River, and the leachability of wastes and wastewaters.

NOTE: Solutions are unbuffered and exact pH may not be attained.

5.4.2 Extraction fluid #2: This fluid is made by adding the 60/40 weight percent mixture of sulfuric and nitric acids to reagent water (Step 5.2) until the pH is 5.00 ± 0.05 . The fluid is used to determine the leachability of soil from a site that is west of the Mississippi River.

5.4.3 Extraction fluid #3: This fluid is reagent water (Step 5.2) and is used to determine cyanide and volatiles leachability.

NOTE: These extraction fluids should be monitored frequently for impurities. The pH should be checked prior to use to ensure that these fluids are made up accurately. If impurities are found or the pH is not within the above specifications, the fluid shall be discarded and fresh extraction fluid prepared.

5.5 Analytical standards shall be prepared according to the appropriate analytical method.

6.0 SAMPLE COLLECTION, PRESERVATION, AND HANDLING

6.1 All samples shall be collected using an appropriate sampling plan.

6.2 There may be requirements on the minimal size of the field sample depending upon the physical state or states of the waste and the analytes of concern. An aliquot is needed for the preliminary evaluations of the percent solids and the particle size. An aliquot may be needed to conduct the nonvolatile analyte extraction procedure (see Step 1.4 concerning the use of this extract for volatile organics). If volatile organics are of concern, another aliquot may be needed. Quality control measures may require additional aliquots. Further, it is always wise to collect more sample just in case something goes wrong with the initial attempt to conduct the test.

6.3 Preservatives shall not be added to samples before extraction.

6.4 Samples may be refrigerated unless refrigeration results in irreversible physical change to the waste. If precipitation occurs, the entire sample (including precipitate) should be extracted.

6.5 When the sample is to be evaluated for volatile analytes, care shall be taken to minimize the loss of volatiles. Samples shall be collected and stored in a manner intended to prevent the loss of volatile analytes (e.g., samples should be collected in Teflon-lined septum capped vials and stored at 4°C. Samples should be opened only immediately prior to extraction).

6.6 1312 extracts should be prepared for analysis and analyzed as soon as possible following extraction. Extracts or portions of extracts for metallic analyte determinations must be acidified with nitric acid to a pH < 2, unless precipitation occurs (see Step 7.2.14 if precipitation occurs). Extracts should be preserved for other analytes according to the guidance given in the individual analysis methods. Extracts or portions of extracts for organic analyte determinations shall not be allowed to come into contact with the atmosphere (i.e., no headspace) to prevent losses. See Section 8.0 (Quality Control) for acceptable sample and extract holding times.

7.0 PROCEDURE

7.1 Preliminary Evaluations

Perform preliminary 1312 evaluations on a minimum 100 gram aliquot of sample. This aliquot may not actually undergo 1312 extraction. These preliminary evaluations include: (1) determination of the percent solids (Step 7.1.1); (2) determination of whether the waste contains insignificant solids and is, therefore, its own extract after filtration (Step 7.1.2); and (3) determination of whether the solid portion of the waste requires particle size reduction (Section 7.1.3).

7.1.1 Preliminary determination of percent solids: Percent solids is defined as that fraction of a waste sample (as a percentage of the total sample) from which no liquid may be forced out by an applied pressure, as described below.

7.1.1.1 If the sample will obviously yield no free liquid when subjected to pressure filtration (i.e., is 100% solids), weigh out a representative subsample (100 g minimum) and proceed to Step 7.1.3.

7.1.1.2 If the sample is liquid or multiphasic, liquid/solid separation to make a preliminary determination of percent solids is required. This involves the filtration device discussed in Step 4.3.2, and is outlined in Steps 7.1.1.3 through 7.1.1.9.

7.1.1.3 Pre-weigh the filter and the container that will receive the filtrate.

7.1.1.4 Assemble filter holder and filter following the manufacturer's instructions. Place the filter on the support screen and secure.

7.1.1.5 Weigh out a subsample of the waste (100 gram minimum) and record the weight.

7.1.1.6 Allow slurries to stand to permit the solid phase to settle. Samples that settle slowly may be centrifuged prior to filtration. Centrifugation is to be used only as an aid to filtration. If used, the liquid should be decanted and filtered followed by filtration of the solid portion of the waste through the same filtration system.

7.1.1.7 Quantitatively transfer the sample to the filter holder (liquid and solid phases). Spread the sample evenly over the surface of the filter. If filtration of the waste at 4°C reduces the amount of expressed liquid over what would be expressed at room temperature, then allow the sample to warm up to room temperature in the device before filtering.

NOTE: If sample material (>1 percent of original sample weight) has obviously adhered to the container used to transfer the sample to the filtration apparatus, determine the weight of this residue and subtract it from the sample weight determined in Step 7.1.1.5 to determine the weight of the sample that will be filtered.

Gradually apply vacuum or gentle pressure of 1-10 psi, until air or pressurizing gas moves through the filter. If this point is not reached under 10 psi, and if no additional liquid has passed through the filter in any 2-minute interval, slowly increase the pressure in 10 psi increments to a maximum of 50 psi. After each incremental increase of 10 psi, if the pressurizing gas has not moved through the filter, and if no additional liquid has passed through the filter in any 2-minute interval, proceed to the next 10-psi increment. When the pressurizing gas begins to move through the filter, or when liquid flow has ceased at 50 psi (*i.e.*, filtration does not result in any additional filtrate within any 2-minute period), stop the filtration.

NOTE: Instantaneous application of high pressure can degrade the glass fiber filter and may cause premature plugging.

7.1.1.8 The material in the filter holder is defined as the solid phase of the sample, and the filtrate is defined as the liquid phase.

NOTE: Some samples, such as oily wastes and some paint wastes, will obviously contain some material that appears to be a liquid, but even after applying vacuum or pressure filtration, as outlined in Step 7.1.1.7, this material may not filter. If this is the case, the material within the filtration device is defined as a solid. Do not replace the original filter with a fresh filter under any circumstances. Use only one filter.

7.1.1.9 Determine the weight of the liquid phase by subtracting the weight of the filtrate container (see Step 7.1.1.3) from the total weight of the filtrate-filled container. Determine the weight of the solid phase of the sample by subtracting the weight of the liquid phase from the weight of the total sample, as determined in Step 7.1.1.5 or 7.1.1.7.

Record the weight of the liquid and solid phases. Calculate the percent solids as follows:

$$\text{Percent solids} = \frac{\text{Weight of solid (Step 7.1.1.9)}}{\text{Total weight of waste (Step 7.1.1.5 or 7.1.1.7)}} \times 100$$

7.1.2 If the percent solids determined in Step 7.1.1.9 is equal to or greater than 0.5%, then proceed either to Step 7.1.3 to determine whether the solid material requires particle size reduction or to Step 7.1.2.1 if it is noticed that a small amount of the filtrate is entrained in wetting of the filter. If the percent solids determined in Step 7.1.1.9 is less than 0.5%, then proceed to Step 7.2.9 if the nonvolatile 1312 analysis is to be performed, and to Section 7.3 with a fresh portion of the waste if the volatile 1312 analysis is to be performed.

7.1.2.1 Remove the solid phase and filter from the filtration apparatus.

7.1.2.2 Dry the filter and solid phase at $100 \pm 20^{\circ}\text{C}$ until two successive weighings yield the same value within ± 1 percent. Record the final weight.

Note: Caution should be taken to ensure that the subject solid will not flash upon heating. It is recommended that the drying oven be vented to a hood or other appropriate device.

7.1.2.3 Calculate the percent dry solids as follows:

$$\text{Percent dry solids} = \frac{(\text{Weight of dry sample + filter}) - \text{tared weight of filter}}{\text{Initial weight of sample (Step 7.1.1.5 or 7.1.1.7)}} \times 100$$

7.1.2.4 If the percent dry solids is less than 0.5%, then proceed to Step 7.2.9 if the nonvolatile 1312 analysis is to be performed, and to Step 7.3 if the volatile 1312 analysis is to be performed. If the percent dry solids is greater than or equal to 0.5%, and if the nonvolatile 1312 analysis is to be performed, return to the beginning of this Section (7.1) and, with a fresh portion of sample, determine whether particle size reduction is necessary (Step 7.1.3).

7.1.3 Determination of whether the sample requires particle-size reduction (particle-size is reduced during this step): Using the solid portion of the sample, evaluate the solid for particle size. Particle-size reduction is required, unless the solid has a surface area per gram of material equal to or greater than 3.1 cm^2 , or is smaller than 1 cm in its narrowest dimension (i.e., is capable of passing through a 9.5 mm (0.375 inch) standard sieve). If the surface area is smaller or the particle size larger than described above, prepare the solid portion of the sample for extraction by crushing, cutting, or grinding the waste to a surface area or particle size as described above. If the solids are prepared for organic volatiles extraction, special precautions must be taken (see Step 7.3.6).

Note: Surface area criteria are meant for filamentous (e.g., paper, cloth, and similar) waste materials. Actual measurement of surface area is not required, nor is it recommended. For materials that do not obviously meet the criteria, sample-specific methods would need to be developed and employed to measure the surface area. Such methodology is currently not available.

7.1.4 Determination of appropriate extraction fluid:

7.1.4.1 For soils, if the sample is from a site that is east of the Mississippi River, extraction fluid #1 should be used. If the sample is from a site that is west of the Mississippi River, extraction fluid #2 should be used.

7.1.4.2 For wastes and wastewater, extraction fluid #1 should be used.

7.1.4.3 For cyanide-containing wastes and/or soils, extraction fluid #3 (reagent water) must be used because leaching of cyanide-containing samples under acidic conditions may result in the formation of hydrogen cyanide gas.

7.1.5 If the aliquot of the sample used for the preliminary evaluation (Steps 7.1.1 - 7.1.4) was determined to be 100% solid at Step 7.1.1.1, then it can be used for the Section 7.2 extraction (assuming at least 100 grams remain), and the Section 7.3 extraction (assuming at least 25 grams remain). If the aliquot was subjected to the procedure in Step 7.1.1.7, then another aliquot shall be used for the volatile extraction procedure in Section 7.3. The aliquot of the waste subjected to the procedure in Step 7.1.1.7 might be appropriate for use for the Section 7.2 extraction if an adequate amount of solid (as determined by Step 7.1.1.9) was obtained. The amount of solid necessary is dependent upon whether a sufficient amount of extract will be produced to support the analyses. If an adequate amount of solid remains, proceed to Step 7.2.10 of the nonvolatile 1312 extraction.

7.2 Procedure when Volatiles are not Involved

A minimum sample size of 100 grams (solid and liquid phases) is recommended. In some cases, a larger sample size may be appropriate, depending on the solids content of the waste sample (percent solids, See Step 7.1.1), whether the initial liquid phase of the waste will be miscible with the aqueous extract of the solid, and whether inorganics, semivolatile organics, pesticides, and herbicides are all analytes of concern. Enough solids should be generated for extraction such that the volume of 1312 extract will be sufficient to support all of the analyses required. If the amount of extract generated by a single 1312 extraction will not be sufficient to perform all of the analyses, more than one extraction may be performed and the extracts from each combined and aliquoted for analysis.

7.2.1 If the sample will obviously yield no liquid when subjected to pressure filtration (i.e., is 100 percent solid, see Step 7.1.1), weigh out a subsample of the sample (100 gram minimum) and proceed to Step 7.2.9.

7.2.2 If the sample is liquid or multiphasic, liquid/solid separation is required. This involves the filtration device described in Step 4.3.2 and is outlined in Steps 7.2.3 to 7.2.8.

7.2.3 Pre-weigh the container that will receive the filtrate.

7.2.4 Assemble the filter holder and filter following the manufacturer's instructions. Place the filter on the support screen and secure. Acid wash the filter if evaluating the mobility of metals (see Step 4.4).

Note: Acid washed filters may be used for all nonvolatile extractions even when metals are not of concern.

7.2.5 Weigh out a subsample of the sample (100 gram minimum) and record the weight. If the waste contains <0.5 percent dry solids (Step 7.1.2), the liquid portion of the waste, after filtration, is defined as the 1312 extract. Therefore, enough of the sample should be filtered so that the amount of filtered liquid will support all of the analyses required of the 1312 extract. For wastes containing >0.5 percent dry solids (Steps 7.1.1 or 7.1.2), use the percent solids information obtained in Step 7.1.1 to determine the optimum sample size (100 gram minimum) for filtration. Enough solids should be generated by filtration to support the analyses to be performed on the 1312 extract.

7.2.6 Allow slurries to stand to permit the solid phase to settle. Samples that settle slowly may be centrifuged prior to filtration. Use centrifugation only as an aid to filtration. If the sample is centrifuged, the liquid should be decanted and filtered followed by filtration of the solid portion of the waste through the same filtration system.

7.2.7 Quantitatively transfer the sample (liquid and solid phases) to the filter holder (see Step 4.3.2). Spread the waste sample evenly over the surface of the filter. If filtration of the waste at 4°C reduces the amount of expressed liquid over what would be expressed at room temperature, then allow the sample to warm up to room temperature in the device before filtering.

NOTE: If waste material (>1 percent of the original sample weight) has obviously adhered to the container used to transfer the sample to the filtration apparatus, determine the weight of this residue and subtract it from the sample weight determined in Step 7.2.5, to determine the weight of the waste sample that will be filtered.

Gradually apply vacuum or gentle pressure of 1-10 psi, until air or pressurizing gas moves through the filter. If this point is not reached under 10 psi, and if no additional liquid has passed through the filter in any 2-minute interval, slowly increase the pressure in 10-psi increments to maximum of 50 psi. After each incremental increase of 10 psi, if the pressurizing gas has not moved through the filter, and if no additional liquid has passed through the filter in any 2-minute interval, proceed to the next 10-psi increment. When the pressurizing gas begins to move through the filter, or when the liquid flow has ceased at 50 psi (i.e., filtration does not result in any additional filtrate within a 2-minute period), stop the filtration.

NOTE: Instantaneous application of high pressure can degrade the glass fiber filter and may cause premature plugging.

7.2.8 The material in the filter holder is defined as the solid phase of the sample, and the filtrate is defined as the liquid phase. Weigh the filtrate. The liquid phase may now be either analyzed (see Steps 7.2.12) or stored at 4°C until time of analysis.

NOTE: Some wastes, such as oily wastes and some paint wastes, will obviously contain some material which appears to be a liquid. Even after applying vacuum or pressure filtration, as outlined in Step 7.2.7, this material may not filter. If this is the case, the material within the filtration device is defined as a solid, and is carried through the extraction as a solid. Do not replace the original filter with a fresh filter under any circumstances. Use only one filter.

7.2.9 If the sample contains <0.5% dry solids (see Step 7.1.2), proceed to Step 7.2.13. If the sample contains >0.5 percent dry solids (see Step 7.1.1 or 7.1.2), and if particle-size reduction of the solid was needed in Step 7.1.3, proceed to Step 7.2.10. If the sample as received passes a 9.5 mm sieve, quantitatively transfer the solid material into the extractor bottle along with the filter used to separate the initial liquid from the solid phase, and proceed to Step 7.2.11.

7.2.10 Prepare the solid portion of the sample for extraction by crushing, cutting, or grinding the waste to a surface area or particle-size as described in Step 7.1.3. When the surface area or particle-size has been appropriately altered, quantitatively transfer the solid material into an extractor bottle. Include the filter used to separate the initial liquid from the solid phase.

NOTE: Sieving of the waste is not normally required. Surface area requirements are meant for filamentous (e.g., paper, cloth) and similar waste materials. Actual measurement of surface area is not recommended. If sieving is necessary, a Teflon-coated sieve should be used to avoid contamination of the sample.

7.2.11 Determine the amount of extraction fluid to add to the extractor vessel as follows:

$$\text{Weight of extraction fluid} = \frac{20 \times \% \text{ solids (Step 7.1.1)} \times \text{weight of waste filtered (Step 7.2.5 or 7.2.7)}}{100}$$

Slowly add this amount of appropriate extraction fluid (see Step 7.1.4) to the extractor vessel. Close the extractor bottle tightly (it is recommended that Teflon tape be used to ensure a tight seal), secure in rotary extractor device, and rotate at 30 ± 2 rpm for 18 ± 2 hours. Ambient temperature (i.e., temperature of room in which extraction takes place) shall be maintained at $23 \pm 2^\circ\text{C}$ during the extraction period.

NOTE: As agitation continues, pressure may build up within the extractor bottle for some types of sample (e.g., limed or calcium carbonate-containing sample may evolve gases such as carbon dioxide). To relieve excess pressure, the extractor bottle may be periodically opened (e.g., after 15 minutes, 30 minutes, and 1 hour) and vented into a hood.

7.2.12 Following the 18 ± 2 hour extraction, separate the material in the extractor vessel into its component liquid and solid phases by filtering through a new glass fiber filter, as outlined in Step 7.2.7.

For final filtration of the 1312 extract, the glass fiber filter may be changed, if necessary, to facilitate filtration. Filter(s) shall be acid-washed (see Step 4.4) if evaluating the mobility of metals.

7.2.13 Prepare the 1312 extract as follows:

7.2.13.1 If the sample contained no initial liquid phase, the filtered liquid material obtained from Step 7.2.12 is defined as the 1312 extract. Proceed to Step 7.2.14.

7.2.13.2 If compatible (e.g., multiple phases will not result on combination), combine the filtered liquid resulting from Step 7.2.12 with the initial liquid phase of the sample obtained in Step 7.2.7. This combined liquid is defined as the 1312 extract. Proceed to Step 7.2.14.

7.2.13.3 If the initial liquid phase of the waste, as obtained from Step 7.2.7, is not or may not be compatible with the filtered liquid resulting from Step 7.2.12, do not combine these liquids. Analyze these liquids, collectively defined as the 1312 extract, and combine the results mathematically, as described in Step 7.2.14.

7.2.14 Following collection of the 1312 extract, the pH of the extract should be recorded. Immediately aliquot and preserve the extract for analysis. Metals aliquots must be acidified with nitric acid to pH < 2. If precipitation is observed upon addition of nitric acid to a small aliquot of the extract, then the remaining portion of the extract for metals analyses shall not be acidified and the extract shall be analyzed as soon as possible. All other aliquots must be stored under refrigeration (4°C) until analyzed. The 1312 extract shall be prepared and analyzed according to appropriate analytical methods. 1312 extracts to be analyzed for metals shall be acid digested except in those instances where digestion causes loss of metallic analytes. If an analysis of the undigested extract shows that the concentration of any regulated metallic analyte exceeds the regulatory level, then the waste is hazardous and digestion of the extract is not necessary. However, data on undigested extracts alone cannot be used to demonstrate that the waste is not hazardous. If the individual phases are to be analyzed separately, determine the volume of the individual phases (to ± 0.5 percent), conduct the appropriate analyses, and combine the results mathematically by using a simple volume-weighted average:

$$\text{Final Analyte Concentration} = \frac{(V_1) (C_1) + (V_2) (C_2)}{V_1 + V_2}$$

where:

- V_1 = The volume of the first phase (L).
- C_1 = The concentration of the analyte of concern in the first phase (mg/L).
- V_2 = The volume of the second phase (L).
- C_2 = The concentration of the analyte of concern in the second phase (mg/L).

7.2.15 Compare the analyte concentrations in the 1312 extract with the levels identified in the appropriate regulations. Refer to Section 8.0 for quality assurance requirements.

7.3 Procedure when Volatiles are Involved

Use the ZHE device to obtain 1312 extract for analysis of volatile compounds only. Extract resulting from the use of the ZHE shall not be used to evaluate the mobility of non-volatile analytes (e.g., metals, pesticides, etc.).

The ZHE device has approximately a 500 mL internal capacity. The ZHE can thus accommodate a maximum of 25 grams of solid (defined as that fraction of a sample from which no additional liquid may be forced out by an applied pressure of 50 psi), due to the need to add an amount of extraction fluid equal to 20 times the weight of the solid phase.

Charge the ZHE with sample only once and do not open the device until the final extract (of the solid) has been collected. Repeated filling of the ZHE to obtain 25 grams of solid is not permitted.

Do not allow the sample, the initial liquid phase, or the extract to be exposed to the atmosphere for any more time than is absolutely necessary. Any manipulation of these materials should be done when cold (4°C) to minimize loss of volatiles.

7.3.1 Pre-weigh the (evacuated) filtrate collection container (see Step 4.6) and set aside. If using a TEDLAR[®] bag, express all liquid from the ZHE device into the bag, whether for the initial or final liquid/solid separation, and take an aliquot from the liquid in the bag for analysis. The containers listed in Step 4.6 are recommended for use under the conditions stated in Steps 4.6.1-4.6.3.

7.3.2 Place the ZHE piston within the body of the ZHE (it may be helpful first to moisten the piston O-rings slightly with extraction fluid). Adjust the piston within the ZHE body to a height that will minimize the distance the piston will have to move once the ZHE is charged with sample (based upon sample size requirements determined from Step 7.3, Step 7.1.1 and/or 7.1.2). Secure the gas inlet/outlet flange (bottom flange) onto the ZHE body in accordance with the manufacturer's instructions. Secure the glass fiber filter between the support screens and set aside. Set liquid inlet/outlet flange (top flange) aside.

7.3.3 If the sample is 100% solid (see Step 7.1.1), weigh out a subsample (25 gram maximum) of the waste, record weight, and proceed to Step 7.3.5.

7.3.4 If the sample contains <0.5% dry solids (Step 7.1.2), the liquid portion of waste, after filtration, is defined as the 1312 extract. Filter enough of the sample so that the amount of filtered liquid will support all of the volatile analyses required. For samples containing ≥0.5% dry solids (Steps 7.1.1 and/or 7.1.2), use the percent solids information obtained in Step 7.1.1 to determine the optimum sample size to charge into the ZHE. The recommended sample size is as follows:

7.3.4.1 For samples containing <5% solids (see Step 7.1.1), weigh out a 500 gram subsample of waste and record the weight.

7.3.4.2 For wastes containing >5% solids (see Step 7.1.1), determine the amount of waste to charge into the ZHE as follows:

$$\text{Weight of waste to charge ZHE} = \frac{25}{\text{percent solids (Step 7.1.1)}} \times 100$$

Weigh out a subsample of the waste of the appropriate size and record the weight.

7.3.5 If particle-size reduction of the solid portion of the sample was required in Step 7.1.3, proceed to Step 7.3.6. If particle-size reduction was not required in Step 7.1.3, proceed to Step 7.3.7.

7.3.6 Prepare the sample for extraction by crushing, cutting, or grinding the solid portion of the waste to a surface area or particle size as described in Step 7.1.3.1. Wastes and appropriate reduction equipment should be refrigerated, if possible, to 4°C prior to particle-size reduction. The means used to effect particle-size reduction must not generate heat in and of itself. If reduction of the solid phase of the waste is necessary, exposure of the waste to the atmosphere should be avoided to the extent possible.

NOTE: Sieving of the waste is not recommended due to the possibility that volatiles may be lost. The use of an appropriately graduated ruler is recommended as an acceptable alternative. Surface area requirements are meant for filamentous (e.g., paper, cloth) and similar waste materials. Actual measurement of surface area is not recommended.

When the surface area or particle-size has been appropriately altered, proceed to Step 7.3.7.

7.3.7 Waste slurries need not be allowed to stand to permit the solid phase to settle. Do not centrifuge samples prior to filtration.

7.3.8 Quantitatively transfer the entire sample (liquid and solid phases) quickly to the ZHE. Secure the filter and support screens into the top flange of the device and secure the top flange to the ZHE body in accordance with the manufacturer's instructions. Tighten all ZHE fittings and place the device in the vertical position (gas inlet/outlet flange on the bottom). Do not attach the extraction collection device to the top plate.

Note: If sample material (>1% of original sample weight) has obviously adhered to the container used to transfer the sample to the ZHE, determine the weight of this residue and subtract it from the sample weight determined in Step 7.3.4 to determine the weight of the waste sample that will be filtered.

Attach a gas line to the gas inlet/outlet valve (bottom flange) and, with the liquid inlet/outlet valve (top flange) open, begin applying gentle pressure of 1-10 psi (or more if necessary) to force all headspace slowly out of the ZHE device into a hood. At the first appearance of liquid from the liquid inlet/outlet valve, quickly close the valve and discontinue pressure. If filtration of the waste at 4°C reduces the amount of expressed liquid over what would be expressed at room temperature, then allow the sample to warm up to room temperature in the device before filtering. If the waste is 100 percent solid (see Step 7.1.1), slowly increase the pressure to a maximum of 50 psi to force most of the headspace out of the device and proceed to Step 7.3.12.

7.3.9 Attach the evacuated pre-weighed filtrate collection container to the liquid inlet/outlet valve and open the valve. Begin applying gentle pressure of 1-10 psi to force the liquid phase of the sample into the filtrate collection container. If no additional liquid has passed through the filter in any 2-minute interval, slowly increase the pressure in 10-psi increments to a maximum of 50 psi. After each incremental increase of 10 psi, if no additional liquid has passed through the filter in any 2-minute interval, proceed to the next 10-psi increment. When liquid flow has ceased such that continued pressure filtration at 50 psi does not result in any additional filtrate within a 2-minute period, stop the filtration. Close the liquid inlet/outlet valve, discontinue pressure to the piston, and disconnect and weigh the filtrate collection container.

NOTE: Instantaneous application of high pressure can degrade the glass fiber filter and may cause premature plugging.

7.3.10 The material in the ZHE is defined as the solid phase of the sample and the filtrate is defined as the liquid phase.

NOTE: Some samples, such as oily wastes and some paint wastes, will obviously contain some material which appears to be a liquid. Even after applying pressure filtration, this material will not filter. If this is the case, the material within the filtration device is defined as a solid, and is carried through the 1312 extraction as a solid.

If the original waste contained <0.5 percent dry solids (see Step 7.1.2), this filtrate is defined as the 1312 extract and is analyzed directly. Proceed to Step 7.3.15.

7.3.11 The liquid phase may now be either analyzed immediately (see Steps 7.3.13 through 7.3.15) or stored at 4°C under minimal headspace conditions until time of analysis. Determine the weight of extraction fluid #3 to add to the ZHE as follows:

$$\text{Weight of extraction fluid} = \frac{20 \times \% \text{ solids (Step 7.1.1)} \times \text{weight of waste filtered (Step 7.3.4 or 7.3.8)}}{100}$$

7.3.12 The following steps detail how to add the appropriate amount of extraction fluid to the solid material within the ZHE and agitation of the ZHE vessel. Extraction fluid #3 is used in all cases (see Step 5.7).

7.3.12.1 With the ZHE in the vertical position, attach a line from the extraction fluid reservoir to the liquid inlet/outlet valve. The line used shall contain fresh extraction fluid and should be preflushed with fluid to eliminate any air pockets in the line. Release gas pressure on the ZHE piston (from the gas inlet/outlet valve), open the liquid inlet/outlet valve, and begin transferring extraction fluid (by pumping or similar means) into the ZHE. Continue pumping extraction fluid into the ZHE until the appropriate amount of fluid has been introduced into the device.

7.3.12.2 After the extraction fluid has been added, immediately close the liquid inlet/outlet valve and disconnect the extraction fluid line. Check the ZHE to ensure that all valves are in their closed positions. Manually rotate the device in an end-over-end fashion 2 or 3 times. Reposition the ZHE in the vertical position with the liquid inlet/outlet valve on top. Pressurize the ZHE to 5-10 psi (if necessary) and slowly open the liquid inlet/outlet valve to bleed out any headspace (into a hood) that may have been introduced due to the addition of extraction fluid. This bleeding shall be done quickly and shall be stopped at the first appearance of liquid from the valve. Re-pressurize the ZHE with 5-10 psi and check all ZHE fittings to ensure that they are closed.

7.3.12.3 Place the ZHE in the rotary extractor apparatus (if it is not already there) and rotate at 30 ± 2 rpm for 18 ± 2 hours. Ambient temperature (i.e., temperature of room in which extraction occurs) shall be maintained at $23 \pm 2^\circ\text{C}$ during agitation.

7.3.13 Following the 18 ± 2 hour agitation period, check the pressure behind the ZHE piston by quickly opening and closing the gas inlet/outlet valve and noting the escape of gas. If the pressure has not been maintained (i.e., no gas release observed), the ZHE is leaking. Check the ZHE for leaking as specified in Step 4.2.1, and perform the extraction again with a new sample of waste. If the pressure within the device has been maintained, the material in the extractor vessel is once again separated into its component liquid and solid phases. If the waste contained an initial liquid phase, the liquid may be filtered directly into the same filtrate collection container (i.e., TEDLAR[®] bag) holding the initial liquid phase of the waste. A separate filtrate collection container must be used if combining would create multiple phases, or there is not enough volume left within the filtrate collection container. Filter through the glass fiber filter, using the ZHE device as discussed in Step 7.3.9. All extracts shall be filtered and collected if the TEDLAR[®] bag is used, if the extract is multiphasic, or if the waste contained an initial liquid phase (see Steps 4.6 and 7.3.1).

NOTE: An in-line glass fiber filter may be used to filter the material within the ZHE if it is suspected that the glass fiber filter has been ruptured

7.3.14 If the original sample contained no initial liquid phase, the filtered liquid material obtained from Step 7.3.13 is defined as the 1312 extract. If the sample contained an initial liquid phase, the filtered liquid material obtained from Step 7.3.13 and the initial liquid phase (Step 7.3.9) are collectively defined as the 1312 extract.

7.3.15 Following collection of the 1312 extract, immediately prepare the extract for analysis and store with minimal headspace at 4°C until analyzed. Analyze the 1312 extract according to the appropriate analytical methods. If the individual phases are to be analyzed separately (i.e., are not miscible), determine the volume of the individual phases (to 0.5%), conduct the appropriate analyses, and combine the results mathematically by using a simple volume-weighted average:

$$\text{Final Analyte Concentration} = \frac{(V_1) (C_1) + (V_2) (C_2)}{V_1 + V_2}$$

where:

V_1 = The volume of the first phases (L).

C_1 = The concentration of the analyte of concern in the first phase (mg/L).

V_2 = The volume of the second phase (L).

C_2 = The concentration of the analyte of concern in the second phase (mg/L).

7.3.16 Compare the analyte concentrations in the 1312 extract with the levels identified in the appropriate regulations. Refer to Section 8.0 for quality assurance requirements.

8.0 QUALITY CONTROL

8.1 A minimum of one blank (using the same extraction fluid as used for the samples) for every 20 extractions that have been conducted in an extraction vessel.

8.2 A matrix spike shall be performed for each waste type (e.g., wastewater treatment sludge, contaminated soil, etc.) unless the result exceeds the regulatory level and the data is being used solely to demonstrate that the waste property exceeds the regulatory level. A minimum of one matrix spike must be analyzed for each analytical batch. The bias determined from the matrix spike determination shall be used to correct the measured values. (See Steps 8.2.4 and 8.2.5) As a minimum, follow the matrix spike addition guidance provided in each analytical method.

8.2.1 Matrix spikes are to be added after filtration of the 1312 extract and before preservation. Matrix spikes should not be added prior to 1312 extraction of the sample.

8.2.2 In most cases, matrix spike levels should be added at a concentration equivalent to the corresponding regulatory level. If the analyte concentration is less than one half the regulatory level, the spike concentration may be as low as one half of the analyte concentration, but may not be less than five times the method detection limit. In order to avoid differences in matrix effects, the matrix spikes must be added to the same nominal volume of 1312 extract as that which was analyzed for the unspiked sample.

8.2.3 The purpose of the matrix spike is to monitor the performance of the analytical methods used, and to determine whether matrix interferences exist. Use of other internal calibration methods, modification of the analytical methods, or use of alternate analytical methods may be needed to accurately measure the analyte concentration in the 1312 extract when the recovery of the matrix spike is below the expected analytical method performance.

8.2.4 Matrix spike recoveries are calculated by the following formula:

$$\%R (\% \text{ Recovery}) = 100 (X_s - X_u) / K$$

where:

X_s = measured value for the spiked sample
 X_u = measured value for the unspiked sample, and
 K = known value of the spike in the sample.

8.2.5 Measured values are corrected for analytical bias using the following formula:

$$X_c = 100 (X_u / \%R)$$

where:

X_c = corrected value, and
 X_u = measured value of the unspiked sample.

8.3 All quality control measures described in the appropriate analytical methods shall be followed.

8.4 Samples must undergo 1312 extraction within the following time periods:

SAMPLE MAXIMUM HOLDING TIMES (days)

	From: Field Collection To: 1312 extrac- tion	From: 1312 extrac- tion To: Prepara- tive extrac- tion	From: Prepara- tive extrac- tion To: determi- native analysis	Total Elapsed Time
Volatiles	14	NA	14	28
Semi- volatiles	14	7	40	61
Mercury	28	NA	28	56
Metals, except mercury	180	NA	180	360
NA = Not Applicable				

If sample holding times are exceeded, the values obtained will be considered minimal concentrations. Exceeding the holding time is not acceptable in establishing that a waste does not exceed the regulatory level. Exceeding the holding time will not invalidate characterization if the waste exceeds the regulatory level.

9.0 METHOD PERFORMANCE

9.1 Precision results for semi-volatiles and metals: An eastern soil with high organic content and a western soil with low organic content were used for the semi-volatile and metal leaching experiments. Both types of soil were analyzed prior to contaminant spiking. The results are shown in Table 6. The concentrations of contaminants leached from the soils were consistently reproducible, as shown by the low relative standard deviations (RSDs) of the recoveries (generally less than 10 % for most of the compounds).

9.2 Precision results for volatiles: Four different soils were spiked and tested for the extraction of volatiles. Soils One and Two were from western and eastern Superfund sites. Soils Three and Four were mixtures of a western soil with low organic content and two different municipal sludges. The results are shown in Table 7. Extract concentrations of volatile organics from the eastern soil were lower than from the western soil. Replicate leachings of Soils Three and Four showed lower precision than the leachates from the Superfund soils.

10.0 REFERENCES

- 1.0 Environmental Monitoring Systems Laboratory, "QA Support for RCRA Testing: Annual Report". EPA Contract 68-03-3249, January 1989.
- 2.0 Research Triangle Institute, "Interlaboratory Comparison of Methods 1310, 1311, and 1312 for Lead in Soil". U.S. EPA Contract 68-01-7075, November 1988.

Table 1. Volatile Analytes¹

Compound	CAS No.
Acetone	67-64-1
Benzene	71-43-2
n-Butyl alcohol	71-36-3
Carbon disulfide	75-15-0
Carbon tetrachloride	56-23-5
Chlorobenzene	108-90-7
Chloroform	67-66-3
1,2-Dichloroethane	107-06-2
1,1-Dichloroethylene	75-35-4
Ethyl acetate	141-78-6
Ethyl benzene	100-41-4
Ethyl ether	60-29-7
Isobutanol	78-83-1
Methanol	67-56-1
Methylene chloride	75-09-2
Methyl ethyl ketone	78-93-3
Methyl isobutyl ketone	108-10-1
Tetrachloroethylene	127-18-4
Toluene	108-88-3
1,1,1,-Trichloroethane	71-55-6
Trichloroethylene	79-01-6
Trichlorofluoromethane	75-69-4
1,1,2-Trichloro-1,2,2-trifluoroethane	76-13-1
Vinyl chloride	75-01-4
Xylene	1330-20-7

¹ When testing for any or all of these analytes, the zero-headspace extractor vessel shall be used instead of the bottle extractor.

Table 2. Suitable Rotary Agitation Apparatus¹

Company	Location	Model No.
Analytical Testing and Consulting Services, Inc.	Warrington, PA (215) 343-4490	4-vessel extractor (DC20S); 8-vessel extractor (DC20); 12-vessel extractor (DC20B)
Associated Design and Manufacturing Company	Alexandria, VA (703) 549-5999	2-vessel (3740-2); 4-vessel (3740-4); 6-vessel (3740-6); 8-vessel (3740-8); 12-vessel (3740-12); 24-vessel (3740-24)
Environmental Machine and Design, Inc.	Lynchburg, VA (804) 845-6424	8-vessel (08-00-00) 4-vessel (04-00-00)
IRA Machine Shop and Laboratory	Santurce, PR (809) 752-4004	8-vessel (011001)
Lars Lande Manufacturing	Whitmore Lake, MI (313) 449-4116	10-vessel (10VRE) 5-vessel (5VRE)
Millipore Corp.	Bedford, MA (800) 225-3384	4-ZHE or 4 1-liter bottle extractor (YT300RAHW)

¹ Any device that rotates the extraction vessel in an end-over-end fashion at 30 ±2 rpm is acceptable.

Table 3. Suitable Zero-Headspace Extractor Vessels¹

Company	Location	Model No.
Analytical Testing & Consulting Services, Inc.	Warrington, PA (215) 343-4490	C102, Mechanical Pressure Device
Associated Design and Manufacturing Company	Alexandria, VA (703) 549-5999	3745-ZHE, Gas Pressure Device
Lars Lande Manufacturing ²	Whitmore Lake, MI (313) 449-4116	ZHE-11, Gas Pressure Device
Millipore Corporation	Bedford, MA (800) 225-3384	YT30090HW, Gas Pressure Device
Environmental Machine and Design, Inc.	Lynchburg, VA (804) 845-6424	VOLA-TOX1, Gas Pressure Device

¹ Any device that meets the specifications listed in Step 4.2.1 of the method is suitable.

² This device uses a 110 mm filter.

Table 4. Suitable Filter Holders¹

Company	Location	Model/ Catalogue #	Size
Nucleopore Corporation	Pleasanton, CA (800) 882-7711	425910	142 mm
		410400	47 mm
Micro Filtration Systems	Dublin, CA (800) 334-7132 (415) 828-6010	302400	142 mm
		311400	47 mm
Millipore Corporation	Bedford, MA (800) 225-3384	YT30142HW	142 mm
		XX1004700	47 mm

¹ Any device capable of separating the liquid from the solid phase of the waste is suitable, providing that it is chemically compatible with the waste and the constituents to be analyzed. Plastic devices (not listed above) may be used when only inorganic analytes are of concern. The 142 mm size filter holder is recommended.

Table 5. Suitable Filter Media¹

Company	Location	Model	Pore Size (μ m)
Millipore Corporation	Bedford, MA (800) 225-3384	AP40	0.7
Nucleopore Corporation	Pleasanton, CA (415) 463-2530	211625	0.7
Whatman Laboratory Products, Inc.	Clifton, NJ (201) 773-5800	GFF	0.7
Micro Filtration Systems	Dublin, CA (800) 334-7132 (415) 828-6010	GF75	0.7

¹ Any filter that meets the specifications in Step 4.4 of the Method is suitable.

TABLE 6 - METHOD 1312 PRECISION RESULTS FOR SEMI-VOLATILES AND METALS

	<u>Eastern Soil (pH 4.2)</u>			<u>Western Soil (pH 5.0)</u>		
	<u>Amount Spiked</u> (μ g)	<u>Amount Recovered*</u> (μ g)	<u>% RSD</u>	<u>Amount Recovered*</u> (μ g)	<u>% RSD</u>	
<u>FORTIFIED ANALYTES</u>						
bis(2-chloroethyl)- ether	1040	834	12.5	616	14.2	
2-Chlorophenol	1620	1010	6.8	525	54.9	
1,4-Dichlorobenzene	2000	344	12.3	272	34.6	
1,2-Dichlorobenzene	8920	1010	8.0	1520	28.4	
2-Methylphenol	3940	1860	7.7	1130	32.6	
Nitrobenzene	1010	812	10.0	457	21.3	
2,4-Dimethylphenol	1460	200	18.4	18	87.6	
Hexachlorobutadiene	6300	95	12.9	280	22.8	
Acenaphthene	3640	210	8.1	310**	7.7	
2,4-Dinitrophenol	1300	896**	6.1	23**	15.7	
2,4-Dinitrotoluene	1900	1150	5.4	585	54.4	
Hexachlorobenzene	1840	3.7	12.0	10	173.2	
gamma BHC (Lindane)	7440	230	16.3	1240	55.2	
beta BHC	640	35	13.3	65.3	51.7	
<u>METALS</u>						
Lead	5000	70	4.3	10	51.7	
Cadmium	1000	387	2.3	91	71.3	

* - Triplicate analyses.

** - Duplicate analyses; one value was rejected as an outlier at the 90% confidence level using the Dixon Q test.

TABLE 7 - METHOD 1312 PRECISION RESULTS FOR VOLATILES

Compound Name	Soil No. 1 (Western)		Soil No. 2 (Eastern)		Soil No. 3 (Western and Sludge)		Soil No. 4 (Western and Sludge)	
	Avg. %Rec.*	%RSD	Avg. %Rec.*	%RSD	Avg. %Rec.**	%RSD	Avg. %Rec.***	%RSD
Acetone	44.0	12.4	43.8	2.25	116.0	11.5	21.3	71.4
Acrylonitrile	52.5	68.4	50.5	70.0	49.3	44.9	51.8	4.6
Benzene	47.8	8.29	34.8	16.3	49.8	36.7	33.4	41.1
n-Butyl Alcohol (1-Butanol)	55.5	2.91	49.2	14.6	65.5	37.2	73.0	13.9
Carbon disulfide	21.4	16.4	12.9	49.5	36.5	51.5	21.3	31.5
Carbon tetrachloride	40.6	18.6	22.3	29.1	36.2	41.4	24.0	34.0
Chlorobenzene	64.4	6.76	41.5	13.1	44.2	32.0	33.0	24.9
Chloroform	61.3	8.04	54.8	16.4	61.8	29.1	45.8	38.6
1,2-Dichloroethane	73.4	4.59	68.7	11.3	58.3	33.3	41.2	37.8
1,1-Dichloroethane	31.4	14.5	22.9	39.3	32.0	54.4	16.8	26.4
Ethyl acetate	76.4	9.65	75.4	4.02	23.0	119.8	11.0	115.5
Ethylbenzene	56.2	9.22	23.2	11.5	37.5	36.1	27.2	28.6
Ethyl ether	48.0	16.4	55.1	9.72	37.3	31.2	42.0	17.6
Isobutanol (4-Methyl -1-propanol)	0.0	ND	0.0	ND	61.8	37.7	76.0	12.2
Methylene chloride	47.5	30.3	42.2	42.9	52.0	37.4	37.3	16.6
Methyl ethyl ketone (2-Butanone)	56.7	5.94	61.9	3.94	73.7	31.3	40.6	39.0
Methyl isobutyl ketone	81.1	10.3	88.9	2.99	58.3	32.6	39.8	40.3
1,1,1,2-Tetrachloro- ethane	69.0	6.73	41.1	11.3	50.8	31.5	36.8	23.8
1,1,2,2-Tetrachloro- ethane	85.3	7.04	58.9	4.15	64.0	25.7	53.6	15.8
Tetrachloroethene	45.1	12.7	15.2	17.4	26.2	44.0	18.6	24.2
Toluene	59.2	8.06	49.3	10.5	45.7	35.2	31.4	37.2
1,1,1-Trichloro- ethane	47.2	16.0	33.8	22.8	40.7	40.6	26.2	38.8
1,1,2-Trichloro- ethane	76.2	5.72	67.3	8.43	61.7	28.0	46.4	25.4
Trichloroethene	54.5	11.1	39.4	19.5	38.8	40.9	25.6	34.1
Trichloro- fluoromethane	20.7	24.5	12.6	60.1	28.5	34.0	19.8	33.9
1,1,2-Trichloro- trifluoroethane	18.1	26.7	6.95	58.0	21.5	67.8	15.3	24.8
Vinyl chloride	10.2	20.3	7.17	72.8	25.0	61.0	11.8	25.4

* Triplicate analyses
 ** Six replicate analyses
 *** Five replicate analyses

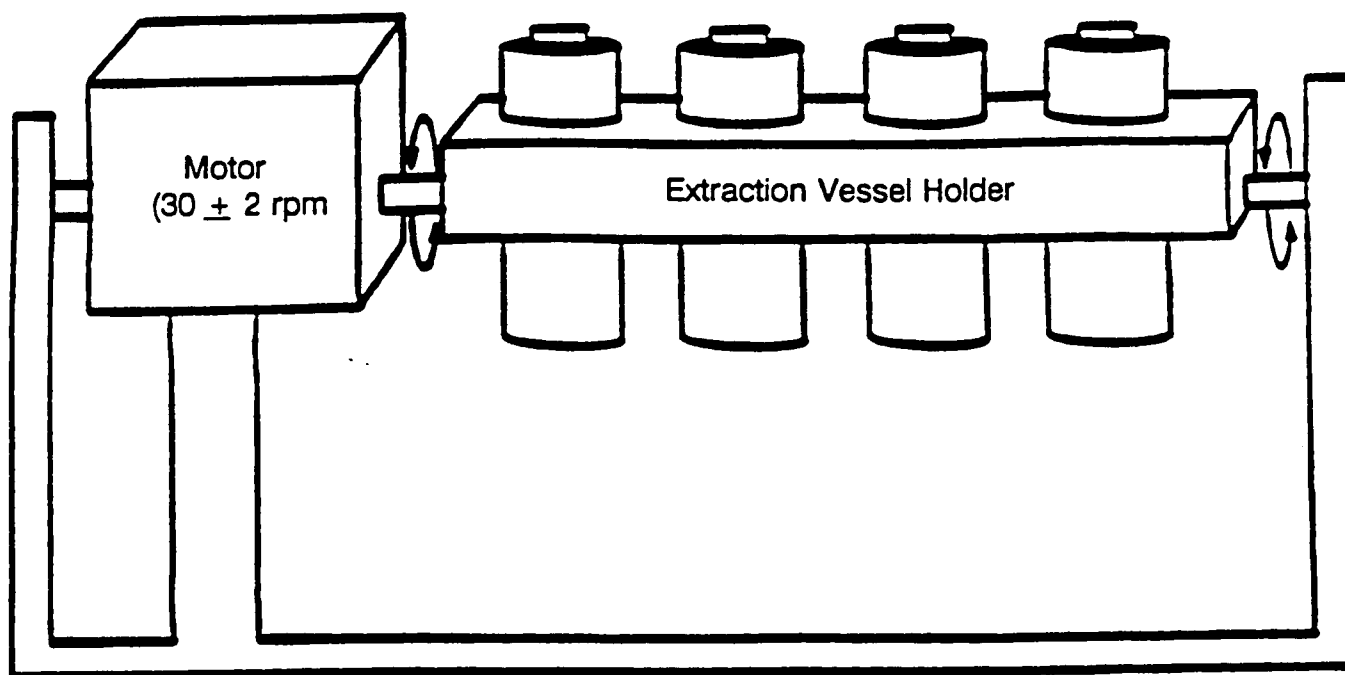

Figure 1. Rotary Agitation Apparatus

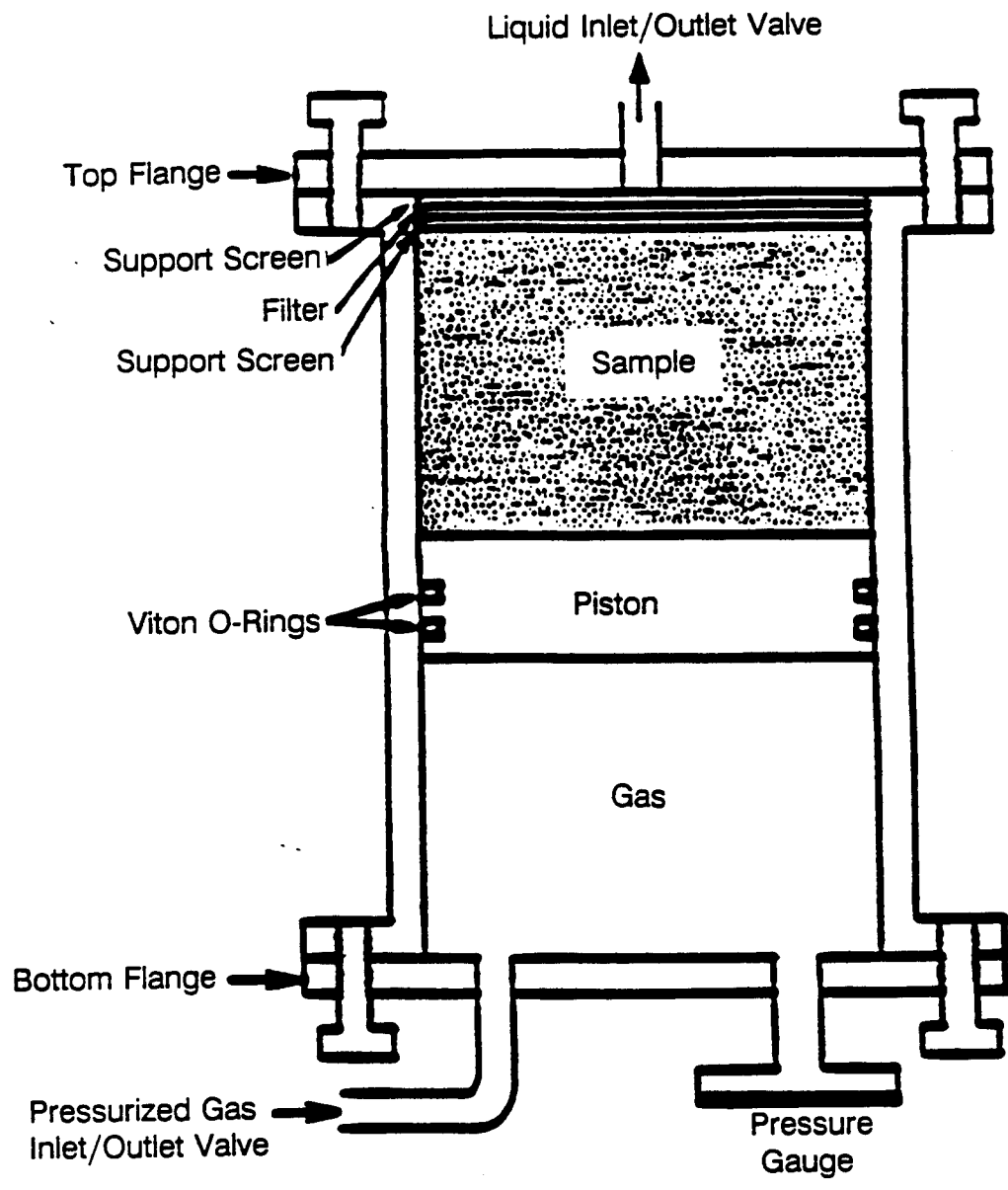
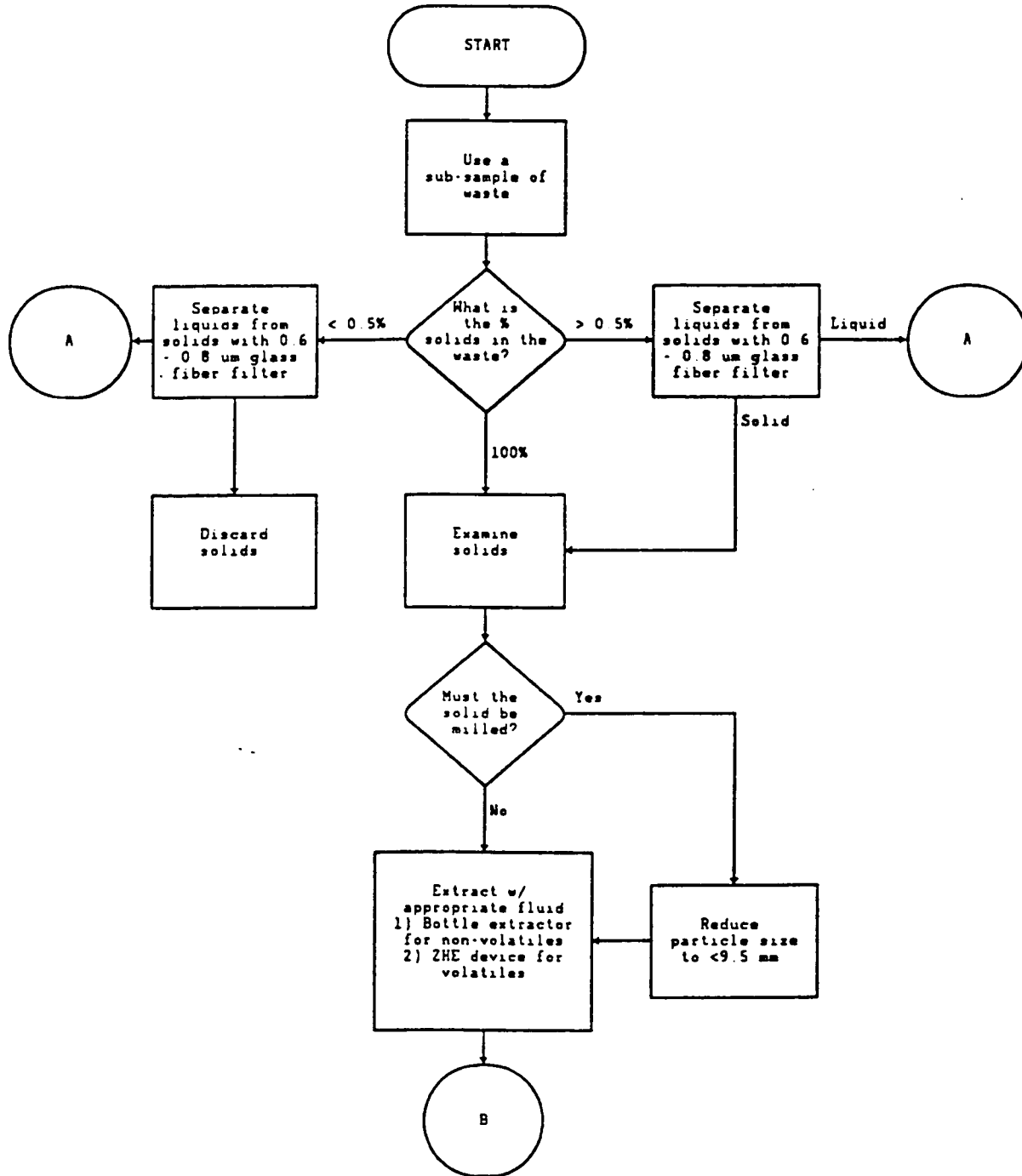

Figure 2. Zero-Headspace Extractor (ZHE)

METHOD 1312
SYNTHETIC PRECIPITATION LEACHING PROCEDURE



METHOD 1312

SYNTHETIC PRECIPITATION LEACHING PROCEDURE (continued)

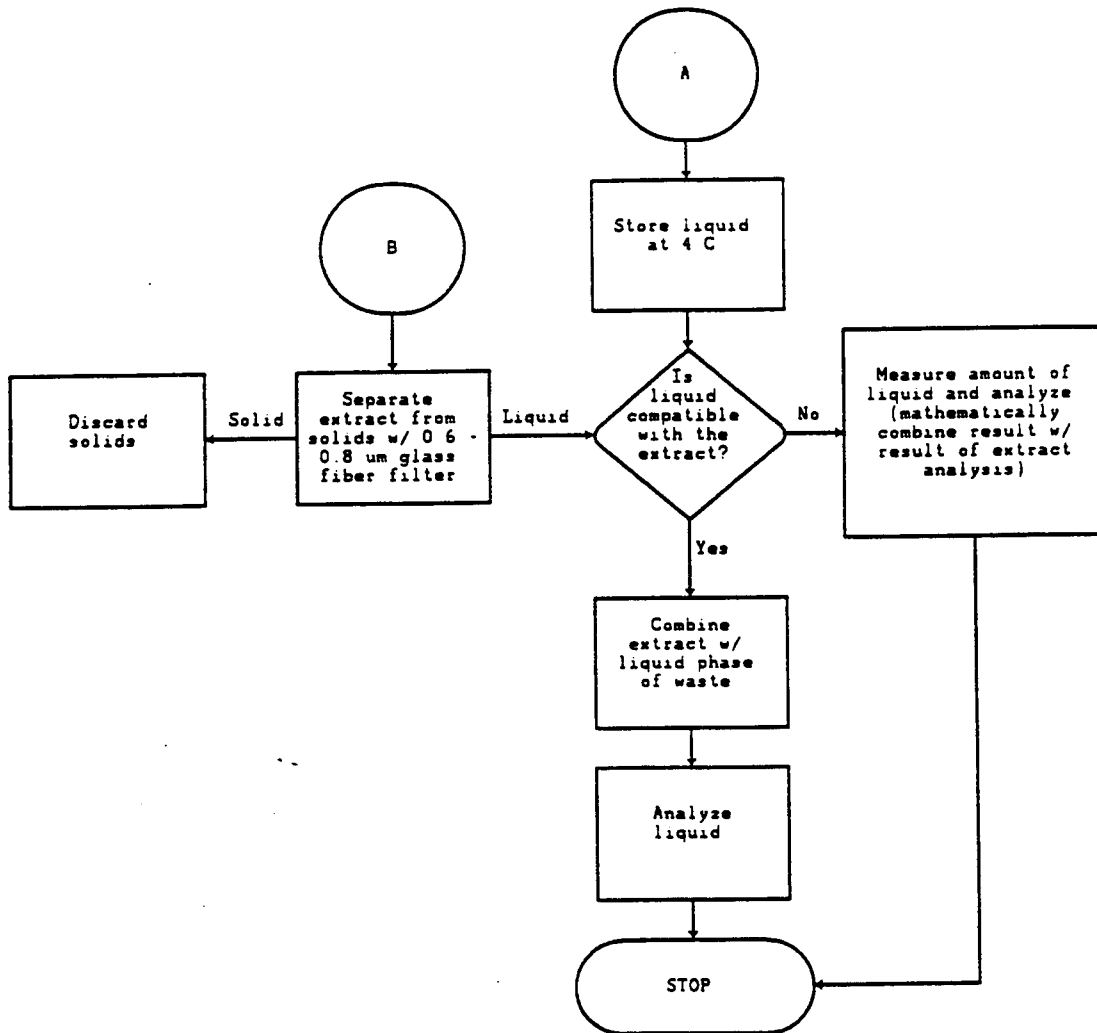

ANALYTICAL METHOD FOR ANALYSIS OF INTERMEDIATES

The analytical method used for explosives intermediates employed soxhlet extraction (EPA Method 3540) and gas chromatography with a nitrogen-phosphorus detector (NPD). Method development work included evaluation of the following:

1. Retention time characteristics of the four amino compounds and the other common explosives with a DB-1701 column and an SPB-5 GC column (both columns are 30 m x 0.53 mm).
2. Appropriate calibration levels for the amino compounds required to provide results within the same concentration ranges as USAEC Method LW02.
3. Method performance, as illustrated by the extraction and analysis of multiple reagent blank samples (n=7) spiked with each of the compounds of interest at 5 ug/g.

Retention time data indicated that all four of the amino-nitrotoluene isomers could be separated from each other on both of the GC columns. The peaks for RDX and 2-amino-4,6-dinitrotoluene co-elute on the DB-1701 column, making this a poor choice for these particular samples because of the elevated levels of RDX already identified by the HPLC analysis.

Calibration data for the standard solutions indicated that the instrument response was linear within the concentration range of 0.5 ug/mL to 50 ug/mL, with a correlation coefficient of at least 0.996 for each of the compounds. (A limit of $\pm 20\%$ would be utilized for mid-level continuing calibration standards, analyzed at a frequency of at least one for every 10 sample extracts. If a standard exceeds this limit, appropriate instrument maintenance would be performed. Any extracts analyzed after the out-of-control standard would be reanalyzed.)

Results for the multiple spiked samples, determined on both the analytical columns, yielded average recoveries within the range of 82% to 106%. Method detection limits for the "blank matrix," calculated as $3.143 \times S$ (S = std. deviation of the seven measurements), ranged from 0.695 $\mu\text{g/g}$ to 1.08 $\mu\text{g/g}$.

Three additional "blank" samples were spiked with high levels (100 $\mu\text{g/g}$) of HMX, RDX, and TNT. These samples were extracted and analyzed, and the associated chromatograms were evaluated for degradation products which might interfere with the determination of the A-DNT and DA-NT isomers. The chromatogram did not exhibit any potential interferences in the retention time region characteristic of the TNT metabolites.

An additional piece of information obtained from the high-level spike study was the fact that HMX did not extract and/or chromatograph very well. This was not apparent during the preliminary low-level spike investigation initially performed for these compounds during the method development, and a late eluting peak which appeared in both the low-level spike and standard chromatograms was erroneously attributed to HMX. When the high-level spike experiment was performed, however, there was no

response attributable to the HMX (it would appear that the peak, which was initially related to HMX, was a low-level interference or breakdown product of one of the other explosives).

Because of temporary delays in receipt of SARMs, it was necessary to use non-SARM laboratory stocks of reference materials to avoid violation of sample holding times restrictions.

The analytical laboratory conducted a comparison between the amino-dinitrotoluene (A-DNT) calibration standards and the corresponding SARMs which were received from USAEC on 14 December 1992. The results indicated that the A-DNT standards used were within the laboratory limits of $\pm 15\%$. A similar analysis was not conducted for the diamino-nitrotoluene (DA-NT) standards because the SARMs for these materials were not received.



APPENDIX E
HAZARD REVIEW OF KW WINDROW COMPOSTER



**HERCULES INCORPORATED
HERCULES AEROSPACE COMPANY
ALLEGANY BALLISTICS LABORATORY
ROCKET CENTER, WEST VIRGINIA**

HAZARD REVIEW OF KW WINDROW COMPOSTER

MARCH 1992

J. H. TATE

**PREPARED FOR
ROY F. WESTON, INC.
WEST CHESTER, PENNSYLVANIA**

AO8426-520-03-001

HERC NO. 92-10

WARRANTY

"Hercules warrants that it has performed the analysis required by the statement of work in a safe and competent manner and in accordance with the standards employed by HERCULES in performing the same or similar analysis for itself. ANY OTHER PROVISIONS OF THIS AGREEMENT TO THE CONTRARY NOT WITHSTANDING, THIS WARRANTY IS IN LIEU OF ALL OTHER WARRANTIES EXPRESS OR IMPLIED, WHETHER ARISING BY LAW, CUSTOM OR CONDUCT INCLUDING WITHOUT LIMITATION, THOSE OF MERCHANTABILITY OR FITNESS FOR A PARTICULAR PURPOSE, THAT ACCIDENTS OR HAZARDS OF ANY KIND WHATSOEVER WILL BE ELIMINATED, THAT ANY PARTICULAR STANDARD OR CRITERION OF HAZARD OR ACCIDENT ELIMINATION OF ANY KIND WHATSOEVER WILL BE ACHIEVED OR THAT ANY PARTICULAR OR ANTICIPATED RESULTS OF ANY KIND WHATSOEVER WILL BE ACHIEVED BY OWNER'S USE OR APPLICATION OF ANY OF THE INFORMATION, ADVICE, RECOMMENDATIONS OR SERVICES PROVIDED IN WHOLE OR IN PART BY HERCULES. ALL SAID INFORMATION, ADVICE, RECOMMENDATIONS OR SERVICES ARE FOR THE SOLE USE OF OWNER AND ARE USED AT OWNER'S RISK. THE RIGHTS AND REMEDIES PROVIDED HEREIN ARE EXCLUSIVE AND IN LIEU OF ANY OTHER RIGHTS OR REMEDIES WHETHER ARISING BY LAW, CUSTOM OR CONDUCT."

CAUTION

CONCLUSIONS PRESENTED IN THIS HAZARD ANALYSIS REPORT ARE BASED UPON THE HARDWARE (OR DESIGN), MATERIAL OF CONSTRUCTION, OPERATING CONDITIONS, PROCESS MATERIALS AND PROCEDURES AS THEY EXISTED AT THE TIME OF THE ANALYSIS (OR AS THEY WERE PRESENTED TO HERCULES FOR ANALYSIS). IF CHANGES IN ANY OF THESE PARAMETERS OCCUR IN THE FUTURE, THE CONCLUSIONS OF THE CURRENT HAZARD ANALYSIS MAY BE INVALIDATED.

TABLE OF CONTENTS

<u>Section</u>	<u>Page</u>
SUMMARY	1
OBJECTIVE	1
CONCLUSIONS AND RECOMMENDATIONS	1
DESIGN AND OPERATING CRITERIA	3
INTRODUCTION	6
BACKGROUND	6
SCOPE AND LIMITATIONS OF THE REVIEW	6
BASIS OF THE REVIEW	6
DISCUSSION	7
DESCRIPTION OF EQUIPMENT AND OPERATION	7
HAZARDOUS MATERIALS	8
SENSITIVITY AND REACTIVITY OF PROCESS MATERIALS	8
Explosives	8
Explosive Contaminated Soil	9
HAZARD REVIEW	10
Wheels and Drive System	12
Flail Drum Assembly	12
Diesel Engine and Hydraulic System	15
Controls and Electrical Equipment	15
REFERENCES	17
DOCUMENTATION	17
TABLES	18
LIST OF ABBREVIATIONS	22

LIST OF TABLES

<u>Table</u>	<u>Title</u>	<u>Page</u>
I	SENSITIVITY DATA - EXPLOSIVES AND CONTAMINATED SOIL	18
II	POTENTIAL INITIATION SCENARIOS FOR WINDROW TURNER	19
III	TYPICAL PROCESS POTENTIALS FOR WINDROW TURNER	21

SUMMARY

OBJECTIVE

The objective of this work is to provide a Hazard Review of the KW compost windrow turner, currently under evaluation by Roy F. Weston, Inc. for the U. S. Army Toxic and Hazardous Material Agency (USATHAMA). The compost turner is being considered for use in the bacteriological treatment of explosive contaminated soil at Umatilla Depot Activity (UMDA). The KW machine is manufactured by Resource Recovery Systems of Nebraska, Inc., located in Sterling, Colorado. The hazard review was undertaken to identify safety critical areas in the design and operation of the composter and to recommend changes in design and operating criteria to mitigate any hazards inherent in the machine and its mode of operation. The Hazard Review was authorized by Weston Subcontract No. M-0081-F2 dated February 18, 1992.

CONCLUSIONS AND RECOMMENDATIONS

The KW compost windrow turner has one high-speed moving part which is in continuous contact with the compost material. This component is the flail drum, which rotates at approximately 800 rpm. The level of energy imparted to the compost material by the action of the flail drum may result in initiation of explosive in the compost by means of impact or friction, particularly if the compost contains rocks or other solid objects, or if the machine is operated without sufficient ground clearance. Also there is a one-inch gap between each end of the drum and the adjacent side panel of the composter, which could act as a pinch point for any rocks or chunks of explosive large enough to become wedged in the gaps, resulting in friction initiation. Other than the flail drum assembly, the only moving parts of the windrow turner likely to be in continuous contact with the compost are the rubber tires. It is expected, however, that virtually all external parts of the unit (including engine, drive components, and hydraulic systems) will become contaminated with compost dust or debris during normal use.

Because of the action of the flail drum when turning a windrow, isolated bits of explosive within the compost are likely to undergo initiation from time to time, even under normal operating conditions. These small-scale, localized initiations would not prevent safe operation of the machine if the individual pieces of explosive are small enough and sufficiently dispersed to prevent sustained burning or transition to an explosion. Thus, in order to operate the windrow turner safely, it will be necessary to disperse the explosive thoroughly throughout the inert material and to exclude large lumps of concentrated explosive from the windrow.

If these conditions are met, then any small isolated bits of explosive in the compost can undergo localized initiation during machine operation, without causing a sustained fire or an explosion. If these conditions are not met, then a sustained fire or explosion could

occur, which might cause operator injury or equipment damage. Even isolated small quantities of explosive can initiate and inflict serious injury to maintenance personnel if the machine is not properly decontaminated prior to maintenance, shutdown, or decommissioning.

Apart from explosion-related hazards, the windrow turner presents a degree of danger to persons nearby, who could be injured either by rocks or debris thrown from the flail drum or by contact with the flails or other exposed moving parts. These hazards can be prevented by keeping clear of the machine when it is in motion. The machine operator should be adequately protected so long as he remains in the cab of the unit.

The most important considerations for safe operation of the compost windrow turner with explosive contaminated soil are to:

- Ensure that the explosive contains no lumps larger than approximately one inch diameter and that the explosive is thoroughly dispersed in the compost material (not to exceed 10% explosive by weight) prior to windrow turning.
- Ensure that the operator remains in the cab whenever the machine is in motion and that other personnel keep clear of the unit when it is operating.
- Remove all explosive contamination from the unit before maintenance, and/or keep the components wet while work is being done.

This report does not recommend any major design modifications to the KW composter, inasmuch as the basic design of the machine allows safe operation with explosive contaminated compost. Some minor modifications are suggested, such as the installation of "dead-man" controls to prevent inadvertent movement of the machine. Installing an optionally available hydraulic drive system for the flail drum instead of the standard belt drive is also recommended. The report also includes recommendations on the operation and maintenance of the windrow turner. On the following pages is a summary of the recommendations made in this report to reduce the probability and severity of potential hazards identified in the review.

DESIGN AND OPERATING CRITERIA

<u>Area</u>	<u>Recommendations</u>
General	<ol style="list-style-type: none">1. Ensure that no large lumps of concentrated explosive are present in the compost prior to windrow turning.2. Ensure that the explosive is thoroughly dispersed throughout the compost material and does not exceed a concentration of 10% by weight in the bulk material.3. Ensure that the operator remains in the cab whenever the machine is in motion.4. Personnel other than the windrow turner operator should keep clear of the unit when it is operating.5. Ensure that the compost is free of large rocks, lumps of concrete, scrap metal, and other solid material prior to windrow turning.6. Consider providing an improved-surface or paved compost pad to eliminate embedded rocks and irregular terrain.7. Maintain the proper moisture level in the compost; avoid turning excessively dry material or allowing material to become dry while in contact with the windrow turner.
Maintenance	<ol style="list-style-type: none">1. Ensure that the windrow turner is completely decontaminated (e.g., using water wash-down) to remove all explosive material before proceeding with maintenance, disassembly, or decommissioning of the unit.2. Keep threaded fittings, bolts, and other components water-wet during disassembly in the event that complete removal of explosive contamination cannot be ensured.

Area

Recommendations

Flail Drum and
Drive System

1. Check lubrication and condition of bearings and seals at frequent intervals to prevent internal contamination of bearings.
2. Check condition of seals and wipers on hydraulic lift cylinders; remove dirt from piston rods and seals after each operating session to prevent buildup.
3. If a belt drive is used for the drum, decontaminate the belt tensioner screw before adjusting tension; remove dirt and debris from belt housing after each operating session to prevent buildup.
4. Consider using hydraulic drum drive instead of belt drive system to reduce exposed moving parts and to provide greater operating control over drum rotation.
5. Consider installing mechanical stops on the hydraulic cylinders to prevent operation below minimum ground clearance.
6. Do not operate the machine unless the rubber shields on the front and rear of the tunnel are intact and properly attached.

Diesel Engine and
Hydraulic System

1. Remove any buildup of dirt and debris from all external surfaces after each operating session.
2. Consider installing a pressurized engine housing or other means of excluding dust from the engine if operating experience shows dust contamination to be a problem.
3. Select lubricants and hydraulic fluid which are compatible with the explosives present in the compost.

Area

Recommendations

Controls and
Electrical Equipment

1. Consider installing a "dead-man" control to stop vehicle movement and drum rotation automatically if operator releases controls.
2. Consider using dust-rated explosion proof electrical components if operating experience shows dust contamination to be a problem.
3. Test windrow turner on level and sloped terrain to evaluate the braking capability of the hydrostatic drive and to determine whether a positive braking system will be needed for safe handling of the vehicle.

INTRODUCTION

BACKGROUND

The subject of this Hazards Review is the KW compost windrow turner, designed and built by Resource Recovery Systems of Nebraska, Inc. (RRSN), located in Sterling, Colorado. This machine is being considered by Roy F. Weston, Inc. for a project involving the bacteriological treatment of explosive contaminated soil as part of the site remediation program at UMDA. The principal explosive in the soil is TNT, with lesser quantities of RDX and HMX also present. The Hazard Review was performed by Hercules, Allegany Ballistics Laboratory (ABL) on the authority of Weston Subcontract No. M-0081-F2 dated February 18, 1992, under USATHAMA Contract No. DACA31-91-D-0079.

SCOPE AND LIMITATIONS OF THE REVIEW

The scope of the hazards review includes the operation of the KW compost windrow turner in handling UMDA compost which contains explosive contaminated soil. The processing and handling of the compost material prior and subsequent to the windrow turning operation are excluded from the scope of the analysis. Maintenance and decommissioning of the windrow turner are included in the operation of the machine. Apart from safety considerations, it is not within the scope of this review to assess the composting process as a method for the treatment of explosive contaminated soil, nor to evaluate the performance of the KW machine for turning windrows. Hazards pertaining to the possible presence of full-up munitions in the composted soil are not considered in this hazards review.

BASIS OF THE REVIEW

The Hazard Review of the compost windrow turner is based on documentation furnished to Hercules-ABL by Weston and by RRSN. Information was also obtained during an inspection of a KW windrow turner located at a waste disposal site in Harford County, MD. Sources of information used in this review are cited in the References and Documentation sections of the report.

DISCUSSION

DESCRIPTION OF EQUIPMENT AND OPERATION

The term "compost windrow" as used in this report refers to a pile of biodegradable material (primarily soil containing explosives, to which organic matter and bulking material are added). In order to promote the composting process, the material in each windrow must be turned (i.e., redistributed) periodically to release excess heat, equalize moisture content, and aerate the material.

The KW machine is designed to handle windrows measuring about 14 to 18 ft wide at the base and 5 to 7 ft high in the center. The length of the windrow normally depends on the space available at the site. Multiple windrows may be laid out in parallel, spaced far enough apart to permit the compost turner to process one windrow without disturbing the adjacent ones.

The KW windrow turner is a device designed to straddle the windrow and move along it from one end to the other, continuously mixing the material by means of a rotating drum fitted with rows of rigid steel teeth, described by the manufacturer as flails. As the machine moves forward, the drum rotates counter to the direction of the drive wheels. This movement causes the compost to be picked up and discharged over the rear of the drum. The drum enclosure tunnel has a trapezoid-shaped rear opening, which shapes the turned compost back into a windrow as the machine moves forward.

The unit rides on four rubber tires. Each of the two front wheels is independently powered by a hydrostatic drive and planetary geartrain. The rear wheels act as non-driven swivel casters. Steering is accomplished by relative changes in the speed of the drive wheels. The operator's cab is located on top of the tunnel. The machine is powered by a 300 hp diesel engine located behind the cab; the engine is turbocharged and water-cooled. The height of the turner can be adjusted by hydraulic cylinders located at each wheel. This arrangement allows a ground clearance adjustment of 17-in at the front and 12-in at the rear, and also permits the machine to be tilted front-to-rear and side-to-side.

The drum is driven at a nominal speed of 800 rpm, using a clutch and belt drive or (optionally) a hydraulic drive. The drum is a 16-inch diameter hollow cylinder of ½-inch thick steel, rotating on a 3.4-inch diameter shaft. The flails (teeth) are individually bolted to mounting pads welded on the drum. The windrow turner is constructed primarily of carbon steel, and weighs approximately 28,000 pounds. It is understood that all main bearings are sealed grease bearings. The maximum speed of forward movement is 4.0 mph (352 ft/min). The speed of the drum varies directly with engine speed.

All operating controls are located in the cab. These include twin "joy-stick" controls governing the direction and speed of the left and right drive wheels, on/off and speed range switches for the drum, controls for the four hydraulic cylinders to adjust the ground clearance and tilt adjustment, plus a diesel engine starting switch and throttle. Gauges are provided for engine RPM, hydraulic oil temperature and pressure, etc. The cab provides full visibility to the front and both sides, and limited visibility to the rear (looking over the engine). The standard KW control system does not include any automatic shutoff switches or "dead-man" controls.

HAZARDOUS MATERIALS

The principal hazardous materials involved in the Umatilla soil composting project are the explosive contaminated soil and the individual explosives which are present in the soil. Based on preliminary sampling studies at UMDA, the explosive expected to be found predominantly in the contaminated soil is TNT (α -trinitrotoluene). In many cases, RDX (cyclo-trimethylene trinitramine) and HMX (cyclotetramethylene tetranitramine) will also be present in lower concentrations than TNT.⁽¹⁾

The types of hazardous material considered in the hazards review are, therefore, limited to TNT, RDX, and HMX. Table I contains results of sensitivity tests of TNT, RDX, HMX, and explosive contaminated soil containing these three materials. The data given in this table are from Hercules test programs, data files, and the literature.^(2,3,4,5) Unless specifically stated otherwise, the term "explosive" is used collectively in this report to refer to the combination of TNT, RDX, and HMX found in the soil at Umatilla.

SENSITIVITY AND REACTIVITY OF PROCESS MATERIALS

Explosives

TNT is a light yellow crystalline explosive. It is one of the most widespread bursting charge explosives, alone or in a binary explosive such as Composition B (TNT and RDX). TNT melts at about 80° C, is very slightly soluble in water, is soluble in acetone and toluene, and is only very slightly hygroscopic. TNT is less sensitive than many military explosives (less sensitive, for example, than RDX or HMX). The presence of impurities such as sulfur or iron oxide tends to increase its sensitivity and decrease its initiation temperature. TNT is chemically stable. No discernible decomposition occurs when TNT is heated to 130° C for 100 hours or to 140° C for 40 hours. However, TNT does undergo marked changes when exposed to sunlight, yielding a product very sensitive to impact.⁽²⁾ TNT is somewhat toxic, but not extremely so.

RDX and HMX are similar in chemical composition and properties. RDX is insoluble and non-hygroscopic. RDX has a melting point of 204° C; HMX melts at 276° C.⁽⁴⁾ Both materials have similar sensitivities and each is more sensitive than TNT, as shown in Table I. Compared with RDX, HMX has a lower initiation temperature and is a slightly less powerful explosive.

Explosive Contaminated Soil

Sensitivity data previously generated by Hercules-ABL for explosive materials and explosive contaminated soil were used, where possible, to support the hazard review of the windrow turner. Where chunks of concentrated explosive might be present at the initiation source, it was necessary to assess the hazard on the basis of pure explosive (TNT/RDX/HMX) as well as for the same explosives mixed and diluted in the compost material. Potential propagation of a fire, and transition of a fire to an explosion, were assessed only on the basis of the mixed soil. This is because, although chunks of pure explosive may be present in the soil, they are likely to be isolated or dispersed rather than contiguous.

In assessing each potential hazard, the "worst case" approach was used. This generally involved examining not only the normal conditions of the windrow turning operation but also the more severe conditions which could occur abnormally. For example, although the windrow material will normally be kept moist, initiation hazards were assessed on the basis of the more sensitive dry material. Likewise, the presence of concentrations of pure explosive at initiation sites was considered, even though the overall concentration of explosive mixed in the process material is not expected to exceed 10 percent.⁽¹⁾ Previous studies have concluded that no explosive reaction occurs from the initiation of soil samples containing less than 10% explosive material.^(6,7) Full-up munitions are not expected to be present in the UMDA soil compost; consequently, the presence of full-up munitions in the composted soil was not considered within the scope of this hazard review.

It is understood that the explosive contaminated soil windrows may be built on an improved surface (asphalt-paved or otherwise) inside an enclosure. Such an enclosure, if used, would facilitate temperature and moisture control of the compost as well as to protect the material from wind erosion.⁽⁸⁾ If the moisture content is maintained within the recommended range for effective composting, potential problems associated with dust and fines from the compost material can be reduced.⁽⁹⁾ The presence of moisture would also be helpful in reducing the sensitivity of the explosives to initiation during processing and handling. A temperature of 112-131° F (45-55° C) inside the pile and a moisture level range of 40-50% by weight are recommended for optimum composting, according to various sources.^(9,10) Research indicates that, under certain conditions, contact with asphalt will accelerate the rate of thermal decomposition of TNT and RDX.⁽¹¹⁾

HAZARD REVIEW

The material response data for explosives (TNT, RDX, HMX) and explosive-contaminated soil are compiled in Table I. The potential hazards and safety critical items identified in the hazard review of the compost windrow turner are summarized in Table II. Typical values for the process potential energy which may be present in these hazards are listed in Table III.

The primary fire and explosion hazards associated with the windrow turner pertain to initiation of the explosive element of the compost from friction, impact, or thermal energy. While the gearboxes, main bearings, and critical drive components are enclosed and sealed against dirt, many of the power train components (drive belts, sheaves, drive shafts, etc.) have little or no protection from dirt and contamination.

Naturally, the compost material will be in intimate contact with the rotating drum and the rubber tires. Nearly all the moving parts except the drive belts and tires are constructed of carbon steel. In most cases the potential initiation energy available from metal-to-metal contact between these moving parts will exceed the threshold initiation level (TIL) of the explosive, so that the probability of an initiation occurring is fairly high.

In order to operate this machine safely, it will be necessary to ensure that the explosive is thoroughly dispersed in the inert material and that no large lumps of concentrated explosive are present in the windrow. If these conditions are met, then the small isolated bits of explosive in the compost are likely to undergo localized initiation during machine operation, but no sustained fire will result and no explosion will occur. If these conditions are not met, then a sustained fire or explosion could occur, which might cause operator injury or equipment damage.

The site of the initiation and the quantity of concentrated explosive involved will largely determine the severity of its consequences. For example, a lump of explosive initiated under a rubber tire, where a high degree of confinement exists, would be likely to explode, possibly damaging the tire and the paved surface (if any) of the compost pad. (The resilient material of the tire would, however, lessen the process potential energy imparted to the explosive.) By comparison, a lump of explosive pinched between the drum and the side wall of the tunnel would be less likely to explode and less likely to cause significant damage or injury.

Maintenance of the unit is likely to create more of an injury hazard than actual operation. The machine will probably acquire a heavy accumulation of compost and dust on all exposed surfaces during windrow turning. This contamination will cause a friction/impact initiation hazard to maintenance personnel unless the machine is thoroughly decontaminated before maintenance is begun. Particular caution should be exercised when handling threaded fittings, hose couplings, and bolts, which tend to trap contaminants in their threads and which create a high level of friction when tightened or loosened.

In machinery which handles friction sensitive materials, normally it is good practice to seal exposed threads with a potting compound to prevent contamination. On the windrow turner, this will be largely impractical. There are a large number of bolts used in the flail mountings, as well as in the engine and various subassemblies. The engine and hydraulic system contain numerous threaded fittings and fasteners. Safe maintenance of the machine will depend on effective removal of the contaminants before maintenance is undertaken. When complete decontamination cannot be assured, it is recommended that the components be kept water-wet during maintenance to lessen the probability of an initiation from friction or impact. Initiation of even a small quantity of explosive could injure a worker in direct contact with the contaminated components. The use of hand tools would provide sufficient friction and impact initiation stimuli to cause initiation if contamination were present at the point of contact.

Aside from the fire and explosion aspects of the operation, the potential for personnel injury from the windrow turner comes primarily from the rotating flail drum and from the movement of the vehicle. When in the cab of the machine, the operator should be well protected from any injury except a fire or explosion. Personnel on the ground close to the machine, however, could be injured by debris thrown from the drum. Accidental contact with the flails could result in a very serious injury. The flexible rubber shields on the front and rear of the tunnel can be expected to reduce the amount of loose material ejected from the tunnel by the rotating drum, but an occasional rock or other object is still likely to be thrown from the machine.

The machine can probably be operated safely, provided that the operator remains in the cab at all times when the machine is in motion and that all ground personnel keep well clear of the unit. Operators and maintenance personnel should be made aware that the compost material contains potentially hazardous explosives, and cautioned to watch for abnormal materials in the compost such as lumps of explosive, scrap metal, rocks, or chunks of concrete.

To summarize, the most important conditions for safe operation of the compost windrow turner with explosive contaminated soil are: (1) The explosive material is free of lumps over one inch in diameter and is thoroughly dispersed in the compost material (not to exceed 10% explosive by weight) prior to windrow turning. (2) The operator remains in the cab whenever the machine is in motion and that all other personnel keep clear of the unit when it is operating. (3) All explosive contamination is removed from the unit before maintenance, and/or keep the components wet while work is being done. Additional safety considerations are discussed in connection with specific sub-units of the KW windrow turner on the following pages.

Wheels and Drive System

The two front wheels are individually powered with a variable speed hydraulic drive. The two rear wheels act simply as swivel casters. The uniform ground pressure under each tire, assuming equal distribution of weight over the entire ground contact area, is estimated on the order of 200 psi (1.38 E6 Pa). The localized pressure exerted by a tire tread on rocky or irregular ground surfaces could increase by an order of magnitude or more. The friction (pressure) exerted by the tires is likely to cause initiation of any propellant pinched or crushed under the tires. This hazard is inherent in the design of the equipment, although it can be minimized by ensuring that the explosive is broken up and dispersed throughout the compost prior to windrow turning. Before maintenance work is undertaken, the tires and all other parts of the machine should be thoroughly washed down to remove all compost material. If complete decontamination cannot be assured, then the equipment should be kept wet during maintenance.

The hydraulic drive motors, planetary gearboxes, and wheel hubs are equipped with sealed, grease-lubricated bearings. As long as the seals are maintained in good condition, the bearings are not likely to become contaminated. If the bearings do become contaminated because of seal damage, poor maintenance, or improper lubrication, then it can be assumed that explosive will enter the bearings along with dirt. Contamination of bearings and gears could increase the probability of injury to maintenance personnel, as well as causing increased wear on the drive components. For the same reasons, the piston rods, seals, and wipers on the hydraulic lift cylinders should be kept in good condition, and should be cleaned between operating sessions to prevent dirt buildup. The clevis and pin joints on the rear wheel assemblies should also be cleaned periodically to prevent buildup of dirt and contamination.

If the hydraulic fluid should leak out of the hydraulic drive system, it could come in contact with the explosive in the compost material. If the fluid is not compatible with the explosive, the latter could become sensitized, increasing the probability of initiation during operation or maintenance of the machine. It is recommended that a hydraulic fluid be used which is compatible with the explosives present in the compost. Before maintenance is undertaken on the machine, any leaked fluid should be carefully removed, along with any accumulation of compost. Grease and lubricants used on the windrow turner should also be checked for compatibility with the explosives, in order to prevent chemical reaction or sensitization in the event that the lubricants come in contact with the explosives.

Flail Drum Assembly

The flail drum remains in contact with the compost material throughout the windrow turning operation and rotates at a nominal rate of 800 rpm. Even under normal operating conditions, several opportunities for initiation of explosive will exist more or less continuously. These include impingement of explosive against the moving flails or against

the sides and top of the tunnel as the compost material flies from the spinning drum. Impact or friction of the flails against rocks or other solid matter in the compost can also produce sufficient stimulus to initiate the explosive.

Under certain abnormal operating conditions, the number of initiation sources can increase. For example, if the windrow turner is operated without sufficient ground clearance (determined by adjustment of the hydraulic lifting cylinders at each wheel), the flails could strike the compost pad or the underside of the vehicle body could rub the pad, causing friction or impact initiation of the explosive. Metal-to-metal friction could occur if one of the flails becomes loose on its mounting lug, which could cause initiation of any explosive trapped between the flail and the mounting lug. If a flail mounting failed completely, the loose flail along with the bolt and nut would then act as foreign objects in the compost, causing abnormally high friction and impact when struck by the remaining flails.

If flails do come loose when the machine is operating, the lost parts (teeth, nuts, bolts) should be recovered from the windrow before continuing the operation. If not recovered promptly, such tramp metal could cause problems during the subsequent processing of the compost material. During the initial use of the windrow turner, the condition of the drum and flails should be checked frequently in order to determine whether flail failure is likely to occur and whether it creates a significant problem. If loosening of flail bolts is found to be a frequent problem, welding each flail to the drum might be considered as an alternative to the use of bolts.

A potential pinch point exists between each end of the drum and the adjacent side of the tunnel; the gap is approximately one inch. If rocks or other hard objects become lodged in this pinch point, an abnormally high level of friction would occur which could lead to initiation of the explosive. Frequent or severe pinching of rocks and hard material could also lead to premature failure of the thrust bearings on the drum shaft.

Some of the above hazards (e.g., improper ground clearance or loose flail bolts) can be controlled by careful pre-operational checks and proper operation of the windrow turner. The other hazards mentioned, such as impingement of explosive against the flails or tunnel surfaces or abnormal friction and impact when the flails strike a rock in the compost, may be regarded as unavoidable consequences of this type of operation. (Based on a comparison between the sensitivity data given in Table I and the typical process potential energies given in Table III, initiation by impact or friction is more likely than impingement initiation.)

These hazards can be reduced to some extent by improving the site to rid the compost pad of embedded rocks and other solid material and by careful preparation of the compost material prior to windrow turning to ensure that the material contains no lumps of concentrated explosive. When these conditions are met, then localized initiation can occur involving small quantities of explosive dispersed throughout the inert material, without propagation to a sustained fire or transition to an explosion. The use of a hand-held metal

detector is suggested to aid in locating and removing any tramp metal from the compost prior to windrow turning.

Although the drive belt system for the flail drum is covered with an expanded metal guard, it remains liable to contamination from compost and explosive which sift through the mesh. The drum shaft is equipped with sealed bearings which should exclude contamination if the seals are maintained in good condition and the bearings properly lubricated. The drive components most likely to be contaminated by dirt and explosive are the drive belts and sheaves.

The input shaft and universal joints at the top end of the belt drive system are also exposed to contamination, although their location on the top deck of the unit protects them from direct contact with the compost. The friction between these moving parts may be sufficient to cause initiation of any explosive present when the parts rub together. The drive belts, sheaves, shafts, and bearings should be washed to remove compost material and possible explosive contamination prior to maintenance, and kept wet during maintenance if complete decontamination is not possible. The screw shaft on the belt tensioner should always be decontaminated before the tension is adjusted.

Most of the hazards associated with the drum drive system can be eliminated if the optional hydraulic drive is selected instead of the belt drive. In this way, the exposed moving parts of the drive train are reduced in number. Additionally, the hydraulic drum drive option would allow the drum speed to be controlled independently of the diesel engine. Hazards associated with hydraulic drives are discussed in the section on Wheels and Drive System.

Operating experience and attention to the manufacturer's recommendations will be important when adjusting the ground clearance of the windrow turner. On a smooth, level, improved compost pad the unit would be expected to operate successfully using a clearance of 1 or 2 inches. If the unit is operated over rough terrain such as rocks or broken pavement, however, insufficient clearance is likely to damage the flails, increase the load on the drum drive, and possibly cause the flails to pick up rocks or chunks of pavement. If the unit is raised too high, the bottom layer of the windrow will not be turned.

Because the ground clearance varies with the position of the hydraulic lift/tilt cylinders, the clearance could be inadvertently reduced by accidental manipulation of the controls or be caused by loss of hydraulic fluid from the system. The clearance should, therefore, be checked prior to operation. If operating experience shows that it is difficult to maintain a minimum safe ground clearance, consideration should be given to installing a mechanical stop (e.g., a collar on the piston rod) on each lift cylinder to prevent operation of the machine below a pre-set height.

Diesel Engine and Hydraulic System

The principal hazards pertaining to the diesel engine on the windrow turner are initiation of explosive by friction or heat. Within the engine compartment are numerous high-speed moving parts which are subject to contamination, including the radiator fan, the drive shaft for the drum drive (if the drum is belt-driven), and the belt drives for the alternator, fuel pump, hydraulic pump, etc. There are also many hot surfaces exposed to contamination, such as the exhaust manifold, the engine cooling radiator, the hydraulic oil heat exchanger, and the hydraulic pump. The surface temperature of a diesel engine exhaust manifold is normally in the range of 700° F (372° C), for example.⁽¹²⁾

The engine is subject to contamination primarily from air-borne dust rather than direct contact with the compost material, because it is located on the deck behind the operator's cab. Because air-borne material would accumulate on the engine components at a slow rate under most conditions, any friction- or heat-sensitive material would be ignited on contact with moving parts or hot surfaces, or within a short time after initial contact. Therefore, any accumulation of reactive material would be minimal, and the probability of a sustained fire or explosion would be low.

Non-reactive organic material such as grass, straw, or wood chips (if present in the compost) would also create a fire hazard if such material is allowed to contact hot engine surfaces. It is recommended that any buildup of compost or dust be removed from the engine after every operating session. Apart from such fire/explosion considerations, the machine is designed to operate in a dusty environment, so that contamination with compost dust should not present any significant problems during continuous operation.

Maintenance on the engine, however, will become more hazardous if explosive contamination is present. Explosive contamination of threaded fittings, drive belts and sheaves, and other components could cause injury to maintenance personnel if initiated by friction or impact. Before maintenance is undertaken on the diesel engine and other parts of the machine, dust and contamination should be removed as completely as possible, particularly in the areas of threaded fittings, drive belts, and other high-friction components. If operating experience with compost indicates that dust contamination of the machinery is a serious problem, consideration should be given to installing a pressurized engine housing or some other means of "dust-proofing" the engine.

Controls and Electrical Equipment

All of the operating controls for the windrow turner are located inside the cab. The main maneuvering controls are two "joy-sticks" which control the hydraulic drive motors on the two drive wheels. These are used to regulate forward and reverse speed and to turn the vehicle. An electric switch is also provided to select an overall range of operating speed (high/medium/low). Another electric switch starts and stops the flail drum. These controls

are arranged so that the vehicle will continue moving and the drum continue rotating if the operator releases the controls. There is no "dead-man" switch or automatic stop function provided. It should also be noted that the unit has no positive braking system. The hydrostatic drive will remove motive power from the drive motors when both control levers are moved to the center-off position, but may not be able to prevent the vehicle rolling free on an incline.

Among the other controls are electrical switches which operate solenoid valves in the hydraulic system to control the lift/tilt adjustment and the drum drive (using either a belt drive with hydraulic clutch or a direct hydraulic drive). The other controls are direct electric type (engine, lights, heating, air conditioning, etc.). These electrical components do not appear to be dust-rated. The solenoid valves are located near the hydraulic pump, which is located immediately below the engine. All the electrical equipment should be considered susceptible to contamination with compost fines and combustible dust. It is recommended that the controls and other electrical equipment be kept clean to minimize contamination from dust and dirt. If operating experience indicates that contamination of electrical equipment is likely to become a problem, then the use of dust-rated explosion proof electrical equipment should be considered.

It is recommended that the controls be designed to stop vehicle movement and drum rotation if the operator releases the controls. In the case of the "joy-sticks" this type of protection could be provided by incorporating a spring-return to the neutral position, approximating the function of a dead-man switch. The windrow turner should be tested operationally to determine whether positive-action brakes are required, based on the type of terrain over which the unit will be used.

REFERENCES

1. W. L. Lowe, fax memo to J. H. Tate, "USATHAMA Compost Study," February 21, 1992.
2. T. Urbanski, *Chemistry and Technology of Explosives*, Vol. I, Polish Scientific Publishers, Warsaw, 1964.
3. *Military Explosives*, Department of the Army Technical Manual TM 9-1300-214, November 1967.
4. *Engineering Design Handbook - Properties of Explosives of Military Interest*, U. S. Army Materiel Command, Pamphlet AMCP 706-177, January 1971.
5. J. H. Tate and T. A. Groce, "Hazard Review of the Fairfield Pilot Composter for the Treatment of Explosive Contaminated Soil," HERC No. 89-50, Hercules-ABL, November 1989.
6. L. S. Treadwell, "Final Report - Reactivity Testing of Explosive Contaminated Soil Samples," HERC No. 86-06, Hercules-ABL, January 1986.
7. F. T. Kristoff et al., "Testing to Determine the Relationship Between Explosive Contaminated Sludge Components and Reactivity," Final Report to USATHAMA, prepared by Arthur D. Little, Inc., January 1987.
8. W. L. Lowe (Roy F. Weston, Inc.), to J. H. Tate, February 19, 1992.
9. "Composting Equipment Handbook," Draft No. 6, SCAT Engineering Div., American Trencher Inc., Delhi, Iowa, February 4, 1991.
10. L. R. Kuhlman, "Windrow Composting of Agricultural and Municipal Wastes," *Resources, Conservation and Recycling*, 4 (1990), Elsevier Science Publishers, Netherlands.
11. T. B. Joyner, *Thermal Decomposition of Explosives*, Part 2, "Effect of Asphalt on the Decomposition of TNT," Naval Weapons Center, China Lake, California, April 1969.
12. T. Baumeister, ed., *Standard Handbook for Mechanical Engineers*, 7th Edition, McGraw-Hill, 1967.

DOCUMENTATION ON KW WINDROW COMPOSTER

"Presenting the KW Windrow Composters," brochure from Resource Recovery Systems of Nebraska, Inc., Sterling, Colorado, undated.

TABLE I - SENSITIVITY DATA FOR SELECTED EXPLOSIVES AND EXPLOSIVE CONTAMINATED SOIL

MATERIAL	TEST	THRESHOLD INITIATION LEVEL*	REMARKS
TNT	Friction	5.85 E8 Pa @ 2.4 m/sec	Hercules Data
	Impact	5.25 E4 J/m ²	Hercules Data
	ESD	0.075 J	Hercules Data
	Impingement	193 m/sec (5/8" x 5/8" dia. sample) 46 m/sec (1-5/8" x 5/8" dia. sample)	Hercules Data Hercules Data
	Initiation Temperature	570° C @ 0.1 sec 465° C @ 10 sec 328° C @ 50 sec 275° C @ 12 min 240° C @ 30 min	AMCP 706-177 ⁽⁴⁾
HMX	Friction	2.2 E8 Pa @ 2.4 m/sec	Hercules data
	Impact	3.0 E4 J/m ²	Hercules data
	ESD	0.075 J	Hercules data
	DSC	250° C (Exotherm onset)	Hercules data
	Initiation Temperature	380° C @ 0.1 sec 306° C @ 10 sec	AMCP 706-177 ⁽⁴⁾
RDX	Friction	3.13 E8 Pa @ 2.4 m/sec	Hercules data
	Impact	2.7 E4 J/m ²	Hercules data
	ESD	0.075 J	Hercules data
	Impingement	207 m/sec	Hercules data
	DSC	216° C (Exotherm onset) 242° C (Peak)	Hercules data
	Initiation Temperature	405° C @ 0.1 sec 235° C @ 15 sec	AMCP 706-177 ⁽⁴⁾
Explosive Contaminated Soil ⁽⁵⁾	Friction	2.3 E8 to 3.1 E8 Pa @ 3.0 m/sec 3.8 E8 to 5.2 E8 Pa @ 0.9 m/sec	Dried Lagoon Sludge
	Impact	8.0 E3 to 1.39 E5 J/m ²	Dried Lagoon Sludge
	Impact	4.75 E4 J/m ²	Composted Sample
	ESD	0.024 to 0.5 J	Dried Lagoon Sludge

*The Threshold Initiation Level (TIL) is the highest energy level at which initiation occurs zero times in 20 successive trials.

TABLE II - POTENTIAL INITIATION SCENARIOS FOR KW WINDROW TURNER

HAZARD DESCRIPTION	INITIATION SOURCE	PROBABLE RESULT	REMARKS
1. Explosive pinched or crushed under tires	Friction (rubber on compost pad surface*)	Localized initiation of explosive	Possible damage to tire; could throw fragments of stone or pavement
2. Flails strike compost pad if ground clearance is not sufficient	Friction or impact (steel on pad surface)	Localized initiation of explosive	Pad surface and flails may be damaged even if initiation does not occur
3. Vehicle body rubs compost pad if ground clearance is not sufficient	Friction (steel on pad surface)	Localized initiation of explosive	Check ground clearance before operating
4. Flail rubs against-mount if bolt is loose	Friction (steel on steel)	Localized initiation of explosive	Check flails before operating
5. Rock or foreign object pinched between drum and tunnel wall	Friction (steel on steel)	Localized initiation of explosive	Could damage drum or bearings (drum to tunnel clearance is approx. 1 inch)
6. Flails strike explosive, or explosive strikes tunnel when leaving drum	Impingement	Localized initiation of explosive	Normal consequence of operation
7. Flails strike foreign material (rock, tramp metal, etc.)	Friction or impact (steel on steel, stone, etc.)	Localized initiation of explosive	Exclude foreign material from compost if possible
8. Drivetrain components (sealed gears and bearings) contaminated with explosive if seals fail	Heat or friction (steel on steel)	Localized initiation of explosive	Machinery damage; keep seals in good condition

*Note: Compost pad surface may consist of earth, rocks, asphalt, and/or concrete.

TABLE II - POTENTIAL INITIATION SCENARIOS FOR KW WINDROW TURNER (cont'd)

HAZARD DESCRIPTION	INITIATION SOURCE	PROBABLE RESULT	REMARKS
9. Explosive contacts drum drive belts	Heat or friction (rubber on steel)	Localized initiation of explosive	Use hydraulic drum drive instead of belt drive
10. Hot engine surfaces (exhaust manifold, radiator, etc.) contaminated with dust containing explosive	Heat	Decomposition or initiation of combustible dust	Consider using pressurized engine compartment if dust problem is severe
11. Electrical components (control switches, solenoids, alternator, battery, etc.) contaminated with dust containing explosive	Heat or electric spark	Decomposition or initiation of combustible dust	Keep controls and electrical equipment clean
12. Lubricating oil or grease becomes contaminated with explosive; explosive may react or become sensitized	Friction, impact, or heat	Greater probability of initiation (maintenance injury hazard)	Use lubricants compatible with explosive
13. Explosive contacts hydraulic fluid; explosive may react or become sensitized	Friction, impact, or heat	Greater probability of initiation (maintenance injury hazard)	Use hydraulic fluid compatible with explosive
14. Flail bolts or other threaded fasteners contaminated with explosive	Friction or impact (steel on steel)	Maintenance injury hazard	Decontaminate threaded fasteners before removing or replacing
15. Hydraulic lift cylinders contaminated with explosive if seals leak	Friction (steel on steel)	Damage to lift cylinders	Remove dirt buildup and check seals periodically

TABLE III - TYPICAL MAXIMUM PROCESS POTENTIAL ENERGIES FOR KW WINDROW TURNER

Electrostatic Discharge

Human Spark: 0.015 Joule

Impingement

Material thrown from drum at 800 rpm: 146 ft/sec (44.7 m/sec)

Impact

Flail strikes loose rock at 147 ft/sec: 1.4 E6 Joules/m²
 (Energy would be greater for rock embedded in ground
 or otherwise held in place)

Friction

Rubber tire rubs ground at 4 mph: 1.7 E7 Pa at 1.8 m/sec
 Steel flail rubs ground at 800 rpm: ≤ 2.9 E8 Pa at 44.7 m/sec
 Drum shaft rubs bearing at 800 rpm: 2.9 E8 Pa at 3.7 m/sec
 Engine output shaft rubs bearing at 2500 rpm: 2.9 E8 Pa at 6.6 m/sec

Thermal

Diesel engine exhaust manifold: 700° F (372° C)

LIST OF ABBREVIATIONS

ABL	Allegany Ballistics Laboratory
AMCP	Army Materiel Command Pamphlet
C	Centigrade
DSC	Differential Scanning Calorimeter
Dia.	Diameter
ESD	Electrostatic Discharge
F	Fahrenheit
ft	Feet
HMX	Cyclotetramethylene Tetranitramine
hp	Horsepower
in	inches
J	Joule
m	Meter
min	Minute
mph	Miles per hour
Pa	Pascal (Newton/m ²) (unit of pressure = psi x 6895)
psi	Pounds per square inch
RDX	Cyclotrimethylene Trinitramine
rpm	Revolutions per minute
RRSN	Resource Recovery Systems of Nebraska, Inc.
sec	Second
TIL	Threshold Initiation Level
TNT	Trinitrotoluene
UMDA	Umatilla Depot Activity
USATHAMA	U. S. Army Toxic and Hazardous Material Agency

APPENDIX F

**RAW EXPLOSIVES DATA
INTERMEDIATES DATA
OXYGEN DEPLETION STUDY DATA**



SEEDING STUDY EXPLOSIVES DATA

DAY	VESSEL	SAMPLE NUMBER	HMX (ug/g)	RDX (ug/g)	1,3,5-TNB (ug/g)	2,4,6-TNT (ug/g)	2,6-DNT (ug/g)	2,4-DNT (ug/g)
0	CA	O11	282	1370	4.07	243	0.48	J 1.73
0	CA	O12	230	1150	3.97	2060	0.76	U 1.67
0	CA	O13	255	1220	2.04	2310	0.78	U 1.94
0	CA	O14	268	1280	4.05	1310	0.78	U 2.00
0	CA	O15	287	1270	4.21	2470	0.81	U 2.21
0	CA	O21	256	1310	4.31	152	0.50	J 2.00
0	CA	O22	220	1170	3.98	250	0.44	J 2.09
0	CA	O23	237	1240	4.37	207	0.84	U 1.62
0	CA	O24	228	1240	4.07	210	0.78	U 1.25
		Average	251.44	1250	2.06	1023.56	0.42	1.83
		Std. Deviation	24.3	67.8	0.1	1012.4	0.0	0.3
10	CA	O11	106	667	4.2	68.2	0.58	J 0.53
10	CA	O12	177	958	4.25	383	0.81	U 0.96
10	CA	O13	204	1140	4.1	294	0.97	U 1.13
10	CA	O14	165	956	4.31	208	1.16	U 1.16
10	CA	O15	143	766	3.99	331	0.76	U 0.78
		Average	159.0	897.4	2.09	256.84	0.70	0.91
		Std. Deviation	36.9	184.6	0.1	123.3	0.3	0.3
20	CA	O11	179	948	4.3	186	0.87	U 1.15
20	CA	O12	184	866	4.29	58.3	0.82	U 0.86
20	CA	O13	150	742	4.09	93.9	0.52	J 0.60
20	CA	O14	160	843	4.22	88.9	0.65	J 0.58
20	CA	O15	158	769	3.86	69.5	0.74	U 0.78
20	CA	O16	198	960	4.44	177	0.75	J 0.95
		Average	171.5	854.67	2.1	112.3	0.6	0.7
		Std. Deviation	18.4	89.6	0.1	55.2	0.2	0.3
40	CA	O31	92.9	145	4.25	4.44	0.81	U 0.85
40	CA	O32	114	345	4.24	75.4	0.81	U 0.85
40	CA	O33	8.15	45.9	4.12	36.1	0.79	U 0.83
40	CA	O34	181	502	4.1	13.9	0.78	U 0.82
40	CA	O35	132	445	4.1	49.6	0.78	U 0.82
		Average	105.61	296.58	2.08	35.9	0.40	0.42
		Std. Deviation	63.5	195.2	0.04	28.4	0.01	0.01

U = Analyzed, Not Detected (lower detection limit shown)

J = Present Below Detection Limits

Averages and standard deviations were calculated using J-values and one-half of the lower detection limit (U-values)

SEEDING STUDY EXPLOSIVES DATA

DAY	VESSEL	SAMPLE NUMBER	HMX (ug/g)	RDX (ug/g)	1,3,5-TNB (ug/g)	2,4,6-TNT (ug/g)	2,6-DNT (ug/g)	2,4-DNT (ug/g)
0	CB	O13	379	1660	3.08	J 3720	0.75	U 1.49
0	CB	O14	439	1900	3.5	J 4260	0.76	U 1.87
0	CB	O15	482	1950	3.71	J 3960	0.82	U 2.70
0	CB	O16	417	1790	2.88	J 3680	0.81	U 1.39
0	CB	O17	369	1640	2.96	J 3720	0.74	U 1.50
		Average	417.2	1788	3.23	3868	0.39	1.79
		Std. Deviation	46.0	138.8	0.4	245.6	0.02	0.54
10	CB	O11	167	668	4.22	U 57.2	0.81	U 0.85
10	CB	O12	211	1080	4.1	U 95.1	0.79	U 0.82
10	CB	O13	198	769	4.24	U 40.8	0.81	U 0.85
10	CB	O14	291	1270	4.34	U 36.9	0.83	U 0.87
10	CB	O15	222	1160	4.25	U 189	0.81	U 0.85
		Average	217.8	989.4	2.12	83.8	0.41	0.42
		Std. Deviation	45.8	258.8	0.0	63.1	0.01	0.01
20	CB	O41	205	622	4.11	U 91	0.79	U 0.83
20	CB	O42	277	1200	4.03	U 117	0.77	U 0.81
20	CB	O43	275	962	4.25	U 12.1	0.81	U 0.85
20	CB	O44	166	443	4.05	U 4.25	0.78	U 0.81
20	CB	O45	302	1080	4.11	U 26.6	0.79	U 0.83
		Average	245.0	861.4	2.055	50.19	0.39	0.41
		Std. Deviation	57.0	318.2	0.0	50.6	0.01	0.01
40	CB	O31	194	249	4.28	U 17.4	J 0.82	U 0.86
40	CB	O32	179	534	4.31	U 25.1	0.83	U 0.87
40	CB	O33	187	328	4.34	U 25	0.83	U 0.87
40	CB	O34	159	310	4.17	U 17.7	0.80	U 0.84
40	CB	O35	181	745	4.26	U 48.9	0.81	U 0.86
		Average	180.0	433.2	2.14	26.82	0.41	0.43
		Std. Deviation	13.1	204.7	0.0	12.9	0.01	0.01

U = Analyzed, Not Detected (lower detection limit shown)

J = Present Below Detection Limits

Averages and standard deviations were calculated using J-values and one-half of the lower detection limit (U-values)

SEEDING STUDY EXPLOSIVES DATA

DAY	VESSEL	SAMPLE NUMBER	HMX (ug/g)	RDX (ug/g)	1,3,5-TNB (ug/g)	2,4,6-TNT (ug/g)	2,6-DNT (ug/g)	2,4-DNT (ug/g)
0	CC	O51	562.0	2560.0	5.56	7010.0	0.80	U
0	CC	O52	386.0	1910.0	3.68	J 5130.0	0.81	U
0	CC	O53	516.0	2330.0	3.29	J 5620.0	0.80	U
0	CC	O54	482.0	2190.0	3.37	J 5590.0	0.79	U
0	CC	O55	384.0	1670.0	2.82	J 4110.0	0.85	U
		Average	466	2132	3.74	5492	0.41	3.02
		Std. Deviation	79.2	349.5	1.06	1045.4	0.01	0.45
10	CC	O11	260.0	968.0	4.30	U 24.4	0.82	U
10	CC	O12	236.0	896.0	4.10	U 115.0	0.79	U
10	CC	O13	197.0	674.0	4.17	U 10.6	0.80	U
10	CC	O14	197.0	571.0	4.18	U 81.8	0.80	U
10	CC	O15	229.0	820.0	4.23	U 94.3	0.81	U
		Average	223.8	785.8	2.10	65.22	0.40	0.42
		Std. Deviation	27.0	162.1	0.04	45.4	0.01	0.01
20	CC	O41	133.0	96.8	4.17	U 9.1	0.80	U
20	CC	O42	160.0	480.0	4.19	U 74.4	0.80	U
20	CC	O43	162.0	423.0	4.22	U 58.2	0.81	U
20	CC	O44	166.0	267.0	3.96	U 10.2	0.76	U
20	CC	O45	155.0	485.0	4.23	U 57.8	0.81	U
		Average	155.2	350.36	2.077	41.94	0.40	0.42
		Std. Deviation	13.0	166.9	0.11	30.2	0.01	0.01
40	CC	143	108.0	146.0	4.22	U 47.9	0.81	U
40	CC	144	155.0	356.0	4.00	U 37.4	0.77	U
40	CC	145	265.0	976.0	4.31	U 88.2	0.82	U
40	CC	146	179.0	159.0	4.03	U 5.4	0.77	U
40	CC	147	233.0	920.0	4.40	U 41.0	0.84	U
		Average	188	511.4	2.10	43.98	0.40	0.42
		Std. Deviation	62.3	407.6	0.17	29.6	0.02	0.02

U = Analyzed, Not Detected (lower detection limit shown)

J = Present Below Detection Limits

Averages and standard deviations were calculated using J-values and one-half of the lower detection limit (U-values)

SEEDING STUDY EXPLOSIVES DATA

DAY	VESSEL	SAMPLE NUMBER	HMX (ug/g)	RDX (ug/g)	1,3,5-TNB (ug/g)	2,4,6-TNT (ug/g)	2,6-DNT (ug/g)	2,4-DNT (ug/g)
0	CD	O51	315.0	1410.0	2.70	J 3880.0	0.80	U 3.11
0	CD	O52	447.0	2000.0	5.34	5780.0	0.80	U 4.22
0	CD	O53	404.0	1700.0	2.86	J 4420.0	0.81	U 3.31
0	CD	O54	299.0	1310.0	3.10	J 3530.0	0.83	U 2.79
0	CD	O55	340.0	1510.0	5.06	4510.0	0.82	U 3.23
		Average	361	1586	3.81	4424	0.41	3.33
		Std. Deviation	62.5	272.6	1.28	857.5	0.01	0.53
10	CD	O11	185.0	876.0	4.28	U 79.8	0.82	U 0.86
10	CD	O12	256.0	1310.0	4.05	U 391.0	0.77	U 0.96
10	CD	O13	152.0	442.0	4.23	U 31.8	0.81	U 0.85
10	CD	O14	190.0	844.0	4.04	U 71.8	0.77	U 0.81
10	CD	O15	250.0	1310.0	4.40	U 182.0	0.84	U 1.03
		Average	206.6	956.4	2.1	151.28	0.40	0.65
		Std. Deviation	44.9	365.3	0.08	145.0	0.02	0.32
20	CD	133	136.0	915.0	4.06	U 98.8	0.78	U 0.82
20	CD	134	133.0	255.0	4.32	U 30.7	0.83	U 0.87
20	CD	135	252.0	695.0	4.31	U 103.0	0.83	U 0.87
20	CD	136	264.0	729.0	4.33	U 135.0	0.83	U 0.87
20	CD	137	183.0	385.0	4.02	U 29.6	0.77	U 0.81
		Average	193.6	595.8	2.10	79.42	0.40	0.42
		Std. Deviation	62.2	269.3	0.08	47.1	0.02	0.02
40	CD	O11	116.0	38.2	4.25	U 8.4	0.81	U 0.85
40	CD	O12	109.0	39.1	4.00	U 11.4	0.77	U 0.80
40	CD	O13	94.1	24.2	4.56	U 29.2	0.87	U 0.92
40	CD	O14	163.0	60.9	4.34	U 7.6	0.83	U 0.87
40	CD	O15	207.0	337.0	3.84	U 10.3	0.73	U 0.77
		Average	137.82	99.88	2.10	13.38	0.40	0.42
		Std. Deviation	46.5	133.2	0.14	9.0	0.03	0.03

U = Analyzed, Not Detected (lower detection limit shown)

J = Present Below Detection Limits

Averages and standard deviations were calculated using J-values and one-half of the lower detection limit (U-values)

SEEDING STUDY EXPLOSIVES DATA

DAY	VESSEL	SAMPLE NUMBER	HMX (ug/g)	RDX (ug/g)	1,3,5-TNB (ug/g)	2,4,6-TNT (ug/g)	2,6-DNT (ug/g)	2,4-DNT (ug/g)
0	SA	O16	274.0	1330.0	4.24	593.0	0.81	2.14
0	SA	O17	251.0	1200.0	4.07	2000.0	0.78	1.87
0	SA	O18	222.0	1200.0	4.11	315.0	0.79	1.20
0	SA	O19	207.0	1020.0	4.30	828.0	0.82	1.55
0	SA	O20	262.0	1150.0	3.94	579.0	0.75	1.52
		Average	243.2	1180	2.07	863	0.40	1.66
		Std. Deviation	27.9	111.6	0.07	661.0	0.01	0.36
10	SA	O16	194.0	1080.0	4.44	145.0	0.93	0.95
10	SA	O17	128.0	694.0	3.89	106.0	0.74	0.78
10	SA	O18	132.0	821.0	4.25	133.0	0.65	0.65
10	SA	O19	149.0	877.0	4.10	186.0	0.61	0.75
10	SA	O20	244.0	1410.0	4.34	348.0	0.81	1.03
		Average	169.4	976.4	2.10	183.6	0.67	0.75
		Std. Deviation	49.2	279.5	0.11	96.3	0.21	0.25
20	SA	O16	198.0	960.0	4.44	177.0	0.75	0.95
20	SA	O17	155.0	768.0	3.92	68.1	0.75	0.79
20	SA	O18	149.0	661.0	4.16	59.9	0.80	0.84
20	SA	O19	219.0	1020.0	4.39	199.0	0.57	0.64
20	SA	O20	157.0	817.0	4.12	41.3	0.79	0.83
		Average	175.6	845.2	2.10	109.06	0.50	0.56
		Std. Deviation	31.1	145.3	0.11	73.1	0.16	0.24
40	SA	O36	168.0	654.0	4.14	75.8	0.79	0.83
40	SA	O37	155.0	616.0	4.12	11.1	0.79	0.83
40	SA	O38	155.0	250.0	4.13	175.0	0.79	0.83
40	SA	O39	137.0	321.0	4.12	4.1	0.79	0.83
40	SA	O40	163.0	628.0	4.12	106.0	0.79	0.83
		Average	155.6	493.8	2.06	74.40	0.40	0.42
		Std. Deviation	11.8	192.3	0.00	70.8	0.00	0.00

U = Analyzed, Not Detected (lower detection limit shown)

J = Present Below Detection Limits

Averages and standard deviations were calculated using J-values and one-half of the lower detection limit (U-values)

SEEDING STUDY EXPLOSIVES DATA

DAY	VESSEL	SAMPLE NUMBER	HMX (ug/g)	RDX (ug/g)	1,3,5-TNB (ug/g)	2,4,6-TNT (ug/g)	2,6-DNT (ug/g)	2,4-DNT (ug/g)
0	SB	O18	421.0	1670.0	2.22	J 2920.0	0.78	U 1.39
0	SB	O19	392.0	1630.0	2.19	J 2720.0	0.79	U 1.28
0	SB	O20	363.0	1470.0	2.02	J 2430.0	0.76	U 1.05
0	SB	O21	354.0	1460.0	2.26	J 2360.0	0.81	U 1.16
0	SB	O22	435.0	1750.0	1.98	J 2680.0	0.81	U 1.71
		Average	393	1596	2.13	2622	0.40	1.32
		Std. Deviation	35.2	127.2	0.13	227.6	0.01	0.25
10	SB	O16	219.0	954.0	4.16	U 89.0	0.80	U 0.84
10	SB	O17	260.0	1160.0	4.17	U 102.0	0.80	U 0.84
10	SB	O18	198.0	987.0	3.97	U 395.0	0.76	U 0.44
10	SB	O19	237.0	1140.0	4.15	U 249.0	0.79	U 0.83
10	SB	O20	232.0	1010.0	4.23	U 161.0	0.81	U 0.85
		Average	229.2	1050.2	2.07	199.2	0.40	0.42
		Std. Deviation	22.9	93.5	0.05	126.4	0.01	0.01
20	SB	O46	237.0	843.0	4.06	U 126.0	0.78	U 0.82
20	SB	O47	294.0	1160.0	4.23	U 59.5	0.81	U 0.85
20	SB	O48	142.0	198.0	4.22	U 4.1	0.81	U 0.85
20	SB	O49	244.0	950.0	4.17	U 62.0	0.80	U 0.84
20	SB	O50	217.0	825.0	4.08	U 99.2	0.78	U 0.82
		Average	226.8	795.2	2.08	70.16	0.40	0.42
		Std. Deviation	55.2	359.5	0.04	46.1	0.01	0.01
40	SB	O36	196.0	521.0	4.27	U 20.1	0.82	U 0.86
40	SB	O37	226.0	726.0	4.22	U 37.9	J 0.81	U 0.85
40	SB	O38	180.0	313.0	4.29	U 50.6	0.82	U 0.86
40	SB	O39	235.0	858.0	4.33	U 19.1	0.83	U 0.87
40	SB	O40	206.0	512.0	4.14	U 81.8	0.79	U 0.83
		Average	208.6	586	2.13	41.9	0.41	0.43
		Std. Deviation	22.3	210.8	0.04	25.9	0.01	0.01

U = Analyzed, Not Detected (lower detection limit shown)

J = Present Below Detection Limits

Averages and standard deviations were calculated using J-values and one-half of the lower detection limit (U-values)

SEEDING STUDY EXPLOSIVES DATA

DAY	VESSEL	SAMPLE NUMBER	HMX (ug/g)	RDX (ug/g)	1,3,5-TNB (ug/g)	2,4,6-TNT (ug/g)	2,6-DNT (ug/g)	2,4-DNT (ug/g)
0	SC	O56	425.0	1880.0	3.07	J	0.80	U
0	SC	O57	432.0	1950.0	2.42	J	0.80	U
0	SC	O58	376.0	1640.0	2.85	J	0.78	U
0	SC	O59	392.0	1750.0	4.20	U	0.80	U
0	SC	O60	451.0	1970.0	2.89	J	0.80	U
		Average	415.2	1838	2.67		0.40	2.41
		Std. Deviation	30.6	140.2			0.00	0.31
10	SC	O16	308.0	1270.0	4.12	U	0.79	U
10	SC	O17	313.0	1290.0	4.28	U	0.82	U
10	SC	O18	259.0	1230.0	4.10	U	0.78	U
10	SC	O19	256.0	1280.0	4.12	U	0.79	U
10	SC	O20	166.0	769.0	4.11	U	0.79	U
		Average	260.4	1167.8	2.07		0.40	0.42
		Std. Deviation	59.1	224.1	0.04		0.01	0.01
20	SC	O46	226.0	589.0	4.22	U	0.81	U
20	SC	O47	213.0	671.0	4.37	U	0.84	U
20	SC	O48	199.0	300.0	4.37	U	0.84	U
20	SC	O49	203.0	511.0	4.36	U	0.83	U
20	SC	O50	200.0	738.0	4.11	U	0.79	U
		Average	208.2	561.8	2.14		0.41	0.43
		Std. Deviation	11.4	169.4	0.06		0.01	0.01
40	SC	148	266.0	279.0	4.12	U	0.79	U
40	SC	149	232.0	712.0	4.42	U	0.85	U
40	SC	150	168.0	179.0	4.15	U	0.79	U
40	SC	151	200.0	130.0	4.31	U	0.83	U
40	SC	152	302.0	1030.0	4.34	U	0.83	U
		Average	233.6	466	2.13		0.41	0.43
		Std. Deviation	52.8	390.1	0.06		0.01	0.01

U = Analyzed, Not Detected (lower detection limit shown)

J = Present Below Detection Limits

Averages and standard deviations were calculated using J-values and one-half of the lower detection limit (U-values)

SEEDING STUDY EXPLOSIVES DATA

DAY	VESSEL	SAMPLE NUMBER	HMX (ug/g)	RDX (ug/g)	1,3,5-TNB (ug/g)	2,4,6-TNT (ug/g)	2,6-DNT (ug/g)	2,4-DNT (ug/g)
0	SD	O56	272.0	1070.0	2.76	J 2760.0	0.83	U 2.45
0	SD	O57	328.0	1510.0	4.82	3980.0	0.76	U 2.82
0	SD	O58	282.0	1250.0	3.87	J 3260.0	0.82	U 2.47
0	SD	O59	364.0	1640.0	3.97	J 4060.0	0.83	U 2.99
0	SD	O60	338.0	1470.0	5.04	3960.0	0.76	U 2.69
		Average	316.8	1388	4.092	3604	0.4	2.68
		Std. Deviation	38.8	226.5	0.90	571.6	0.02	0.23
10	SD	O16	155.0	528.0	4.02	U 91.0	0.77	U 0.81
10	SD	O17	177.0	745.0	4.49	U 159.0	0.86	U 0.90
10	SD	O18	156.0	546.0	4.17	U 16.2	0.80	U 0.84
10	SD	O19	83.9	192.0	4.48	U 43.8	0.86	U 0.90
10	SD	O20	309.0	1670.0	4.12	U 762.0	0.79	U 2.06
		Average	176.18	736.2	2.13	214.4	0.41	0.76
		Std. Deviation	82.2	558.5	0.11	310.9	0.02	0.73
20	SD	138	300.0	1010.0	4.37	U 114.0	0.84	U 0.88
20	SD	139	123.0	250.0	4.12	U 96.1	0.79	U 0.83
20	SD	140	197.0	336.0	4.10	U 23.3	0.78	U 0.82
20	SD	141	80.5	88.3	3.99	U 236.0	0.76	U 0.80
20	SD	142	133.0	199.0	4.44	U 87.0	0.85	U 0.89
		Average	166.7	376.66	2.10	111.28	0.40	0.42
		Std. Deviation	85.4	365.2	0.10	77.7	0.02	0.02
40	SD	O16	151.0	122.0	4.10	U 10.3	0.79	U 0.82
40	SD	O17	162.0	118.0	4.39	U 32.4	0.84	U 0.88
40	SD	O18	53.8	30.6	4.37	U 8.3	0.84	U 0.88
40	SD	O19	135.0	56.7	4.05	U 7.4	0.78	U 0.81
40	SD	O20	165.0	179.0	4.09	U 28.1	0.78	U 0.82
		Average	133.36	101.26	2.1	17.30	0.40	0.42
		Std. Deviation	46.0	58.6	0.08	12.0	0.02	0.02

U = Analyzed, Not Detected (lower detection limit shown)

J = Present Below Detection Limits

Averages and standard deviations were calculated using J-values and one-half of the lower detection limit (U-values)

EXPLOSIVES DATA FOR WINDROWS 7 AND 8

DAY	MATERIAL	SAMPLE NUMBER	HMX (ug/g)	RDX (ug/g)	1,3,5-TNB (ug/g)	2,4,6-TNT (ug/g)	2,6-DNT (ug/g)	2,4-DNT (ug/g)
0	WR7 Comp.	OO8	150.00	1100.00	41.10	591.00	7.86	8.25
0	WR8 Comp.	OO9	209.00	1320.00	41.20	1410.00	7.88	8.28
0	WR7	O77	158.00	997.00	38.50	1560.00	7.38	7.75
0	WR7	O78	216.00	1310.00	4.10	2900.00	7.84	8.24
0	WR7	O79	105.00	678.00	43.20	520.00	8.27	8.68
0	WR7	O80	207.00	1270.00	40.50	2060.00	7.74	8.14
0	WR7	O81	204.00	1260.00	38.70	2770.00	7.41	7.78
0	WR7	O82	208.00	1210.00	2.88	2960.00	0.85	2.49
0	WR7	O83	173.00	982.00	3.73	1340.00	0.71	1.73
0	WR7	O84	210.00	1240.00	4.31	2410.00	0.83	2.30
0	WR7	O85	152.00	982.00	4.54	1470.00	0.87	1.25
0	WR7	O86	167.00	1060.00	1.98	1630.00	0.72	1.69
0	WR7	O87	173.00	1060.00	2.18	2230.00	0.73	2.42
0	WR7	O88	143.00	905.00	3.96	979.00	0.76	1.27
0	WR7	O89	157.00	922.00	3.99	1460.00	0.76	1.77
0	WR7	O90	179.00	1090.00	4.08	1870.00	0.78	2.17
		Average	175.14	1069	7.27	1868.50	1.63	2.67
		Std. Dev.	31.64	176.81	8.45	728.29	1.73	1.14
0	WR8	O91	141.00	826.00	39.70	1510.00	7.59	7.97
0	WR8	O92	142.00	869.00	41.70	998.00	7.98	8.38
0	WR8	O93	169.00	955.00	40.90	823.00	7.83	8.22
0	WR8	O94	139.00	785.00	37.50	1150.00	7.18	7.54
0	WR8	O95	139.00	861.00	39.30	759.00	7.52	7.90
0	WR8	O96	132.00	888.00	4.09	928.00	0.78	0.88
0	WR8	O97	198.00	1160.00	3.82	2820.00	0.74	2.19
0	WR8	O98	179.00	1100.00	4.26	1600.00	0.81	1.56
0	WR8	O99	138.00	878.00	4.11	1020.00	0.79	0.90
0	WR8	100	173.00	987.00	3.94	1690.00	0.75	1.67
0	WR8	101	168.00	990.00	2.47	1950.00	0.74	1.85
0	WR8	102	177.00	980.00	3.22	2210.00	0.81	1.88
0	WR8	103	137.00	851.00	3.34	1990.00	0.84	1.53
0	WR8	104	191.00	1090.00	3.66	2590.00	0.73	2.31
		Average	158.79	944.29	8.88	1574.14	1.61	2.48
		Std. Dev.	22.72	112.85	8.57	667.14	1.70	1.24

U = Analyzed, Not Detected (lower detection limit shown)

J = Present Below Detection Limits

Averages and standard deviations were calculated using J-values and one-half of the lower detection limit (U-values)

EXPLOSIVES DATA FOR WINDROWS 7 AND 8

DAY	MATERIAL	SAMPLE NUMBER	HMX (ug/g)	RDX (ug/g)	1,3,5-TNB (ug/g)	2,4,6-TNT (ug/g)	2,6-DNT (ug/g)	2,4-DNT (ug/g)
5	WR7	105	109.00	928.00	4.66	856.00	0.32	J 1.70
5	WR7	106	151.00	1050.00	3.97	1150.00	0.32	J 1.94
5	WR7	107	176.00	1010.00	4.30	1320.00	0.82	U 1.76
5	WR7	108	115.00	798.00	3.93	460.00	0.30	J 1.04
5	WR7	109	126.00	925.00	4.11	264.00	0.52	J 0.83
5	WR7	110	113.00	793.00	4.44	485.00	0.85	U 0.88
5	WR7	111	156.00	975.00	4.59	1370.00	0.88	U 2.92
5	WR7	112	115.00	820.00	3.74	423.00	0.89	1.43
5	WR7	113	113.00	874.00	3.94	827.00	0.75	U 2.91
5	WR7	114	80.60	779.00	4.05	394.00	0.50	J 1.14
5	WR7	115	122.00	1000.00	4.38	941.00	0.70	J 2.13
5	WR7	116	80.00	794.00	4.14	300.00	0.81	1.04
5	WR7	117	116.00	1060.00	4.20	438.00	0.85	1.33
5	WR7	118	197.00	1310.00	4.49	832.00	1.02	1.92
		Average	126.4	936.86	2.11	718.57	0.56	1.64
		Std. Dev.	33.08	147.05	0.14	376.20	0.24	0.68
5	WR8	119	95.50	811.00	4.20	39.00	0.80	U 0.84
5	WR8	120	95.10	793.00	3.95	57.70	0.76	U 0.79
5	WR8	121	117.00	987.00	4.28	158.00	0.82	U 0.49
5	WR8	122	174.00	1100.00	4.37	80.30	0.84	U 0.90
5	WR8	123	219.00	1430.00	4.38	66.20	0.37	J 1.12
5	WR8	124	193.00	1160.00	4.60	70.20	0.88	U 1.06
5	WR8	125	108.00	919.00	4.13	77.60	0.79	U 0.73
5	WR8	126	178.00	1160.00	4.29	279.00	0.82	U 0.67
5	WR8	127	125.00	1060.00	4.22	73.90	0.81	U 0.85
5	WR8	128	164.00	1250.00	4.03	130.00	0.77	U 0.70
5	WR8	129	168.00	1270.00	4.25	79.60	0.81	U 0.64
5	WR8	130	154.00	1060.00	3.99	58.30	0.40	U 0.70
5	WR8	131	241.00	1490.00	4.09	183.00	0.78	U 0.49
5	WR8	132	187.00	1240.00	4.27	64.00	0.82	U 0.86
		Average	158.47	1123.57	2.11	101.20	0.39	0.66
		Std. Dev.	45.25	207.16	0.09	65.48	0.06	0.24

U = Analyzed, Not Detected (lower detection limit shown)
 J = Present Below Detection Limits
 Averages and standard deviations were calculated using J-values and one-half of the lower detection limit (U-values)

EXPLOSIVES DATA FOR WINDROWS 7 AND 8

DAY	MATERIAL	SAMPLE NUMBER	HMX (ug/g)	RDX (ug/g)	1,3,5-TNB (ug/g)	2,4,6-TNT (ug/g)	2,6-DNT (ug/g)	2,4-DNT (ug/g)
10	WR7	O29	102.00	291.00	4.19	7.79	0.80	0.84
10	WR7	O30	124.00	240.00	4.22	87.40	0.81	0.85
10	WR7	O31	151.00	749.00	4.23	7.94	J	0.85
10	WR7	O32	98.00	105.00	4.24	5.58	J	0.85
10	WR7	O33	107.00	315.00	4.23	5.00	U	0.85
10	WR7	O34	123.00	444.00	4.22	13.80	J	0.85
10	WR7	O35	100.00	443.00	4.18	17.10	U	0.84
10	WR7	O36	107.00	497.00	4.26	14.20	J	0.86
10	WR7	O37	110.00	432.00	4.25	28.90	U	0.85
10	WR7	O38	108.00	194.00	4.24	4.35	J	0.85
10	WR7	O39	110.00	381.00	4.25	19.30	U	0.85
10	WR7	O40	65.20	131.00	4.25	16.50	U	0.85
10	WR7	O41	149.00	690.00	4.25	15.80	U	0.86
10	WR7	O42	143.00	775.00	4.24	34.00	J	0.85
		Average	114.09	406.21	2.12	19.65	0.40	0.43
		Std. Dev.	22.80	216.10	0.01	21.45	0.00	0.00
10	WR8	O43	141.00	721.00	4.21	68.20	U	0.85
10	WR8	O44	108.00	765.00	4.24	6.98	J	0.85
10	WR8	O45	110.00	674.00	4.27	7.98	U	0.86
10	WR8	O46	133.00	810.00	4.26	12.50	U	0.86
10	WR8	O47	115.00	591.00	4.21	17.80	U	0.85
10	WR8	O48	109.00	825.00	4.22	39.80	U	0.85
10	WR8	O49	112.00	687.00	4.16	27.00	U	0.84
10	WR8	O50	111.00	913.00	4.26	95.00	U	0.86
10	WR8	O51	118.00	802.00	4.31	28.80	U	0.87
10	WR8	O52	135.00	910.00	4.24	9.22	U	0.85
10	WR8	O53	112.00	617.00	4.28	10.70	U	0.86
10	WR8	O54	162.00	1120.00	4.71	15.50	U	0.95
10	WR8	O55	117.00	258.00	4.23	12.50	U	0.85
10	WR8	O56	102.00	249.00	4.27	18.10	U	0.86
		Average	120.36	710.14	2.14	26.43	0.41	0.43
		Std. Dev.	16.49	333.75	0.07	25.64	0.01	0.01

U = Analyzed, Not Detected (lower detection limit shown)

J = Present Below Detection Limits

Averages and standard deviations were calculated using J-values and one-half of the lower detection limit (U-values)

EXPLOSIVES DATA FOR WINDROWS 7 AND 8

DAY	MATERIAL	SAMPLE NUMBER	HMX (ug/g)	RDX (ug/g)	1,3,5-TNB (ug/g)	2,4,6-TNT (ug/g)	2,6-DNT (ug/g)	2,4-DNT (ug/g)
15	WR7	O29	54.80	16.90	4.1	31.00	0.78	0.82
15	WR7	O30	93.90	32.20	4.57	11.80	0.87	0.92
15	WR7	O31	53.00	14.50	4.17	4.40	0.80	0.84
15	WR7	O32	92.20	22.40	3.83	3.58	0.73	0.77
15	WR7	O33	90.00	30.00	4.16	3.28	J	0.84
15	WR7	O34	105.00	87.60	3.99	23.20	0.76	0.80
15	WR7	O35	76.20	32.20	4.22	4.30	0.81	0.85
15	WR7	O36	82.40	21.80	3.99	9.06	0.76	0.80
15	WR7	O37	98.10	67.80	4.07	3.41	J	0.82
15	WR7	O38	90.90	65.70	3.96	9.24	0.76	0.80
15	WR7	O39	115.00	52.20	4.68	21.20	0.90	0.94
15	WR7	O40	167.00	149.00	4.11	8.30	0.79	0.83
15	WR7	O41	120.00	164.00	4.27	5.00	0.82	0.86
15	WR7	O42	105.00	154.00	4.30	18.20	0.82	0.88
		Average	95.96	65.02	2.09	11.14	0.40	0.42
		Std. Dev.	28.21	53.62	0.12	8.84	0.02	0.02
15	WR8	O43	132.00	202.00	4.20	16.40	0.80	0.84
15	WR8	O44	123.00	51.00	4.63	17.20	0.89	0.93
15	WR8	O45	31.60	11.50	3.82	8.06	0.73	0.77
15	WR8	O46	137.00	105.00	3.93	10.80	0.75	0.79
15	WR8	O47	123.00	24.90	3.92	7.02	0.75	0.79
15	WR8	O48	55.30	26.40	4.05	36.20	0.77	0.81
15	WR8	O49	98.50	142.00	3.66	30.20	0.70	0.74
15	WR8	O50	129.00	103.00	3.96	11.70	0.76	0.80
15	WR8	O51	127.00	229.00	4.37	9.76	0.84	0.88
15	WR8	O52	149.00	78.80	4.54	11.50	0.87	0.91
15	WR8	O53	76.80	13.60	3.91	16.60	0.75	0.78
15	WR8	O54	102.00	27.50	4.44	18.10	0.85	0.89
15	WR8	O55	95.40	35.20	3.96	24.30	0.76	0.80
15	WR8	O56	32.10	5.64	4.13	9.48	0.79	0.83
		Average	100.84	75.40	2.05	16.24	0.39	0.41
		Std. Dev.	38.50	72.29	0.14	8.66	0.03	0.03

U = Analyzed, Not Detected (lower detection limit shown)

J = Present Below Detection Limits

Averages and standard deviations were calculated using J-values and one-half of the lower detection limit (U-values)

EXPLOSIVES DATA FOR WINDROWS 7 AND 8

DAY	MATERIAL	SAMPLE NUMBER	HMX (ug/g)	RDX (ug/g)	1,3,5-TNB (ug/g)	2,4,6-TNT (ug/g)	2,6-DNT (ug/g)	2,4-DNT (ug/g)
20	WR7	O29	50.50	3.25	4.12	4.44	0.79	0.83
20	WR7	O30	57.10	7.04	4.06	6.83	0.78	0.82
20	WR7	O31	67.10	24.30	4.01	9.71	0.77	0.81
20	WR7	O32	28.90	8.48	4.19	40.80	0.80	0.84
20	WR7	O33	45.20	2.46	4.14	6.79	0.79	0.83
20	WR7	O34	43.90	3.08	3.76	2.89	J	0.76
20	WR7	O35	64.90	3.24	4.23	3.48	J	0.85
20	WR7	O36	34.20	1.97	4.20	4.47	0.80	0.84
20	WR7	O37	74.20	7.79	3.91	2.75	J	0.78
20	WR7	O38	54.90	3.97	3.90	5.91	0.75	0.78
20	WR7	O39	55.10	15.30	4.36	8.18	0.83	0.88
20	WR7	O40	71.90	25.60	4.15	2.89	J	0.83
20	WR7	O41	87.00	17.80	4.09	19.10	0.78	0.82
20	WR7	O42	74.90	24.50	4.04	5.44	0.77	0.81
		Average	57.84	10.56	2.04	8.83	0.39	0.41
		Std. Dev.	16.56	9.08	0.08	10.12	0.01	0.02
20	WR8	O43	2.46	1.58	J	4.18	0.78	0.81
20	WR8	O44	2.50	6.08	4.11	4.28	0.79	0.83
20	WR8	O45	2.48	22.90	4.08	39.80	0.78	0.82
20	WR8	O46	2.47	1.32	J	3.45	J	0.82
20	WR8	O47	2.41	3.85	3.97	11.50	0.76	0.80
20	WR8	O48	2.51	1.20	J	3.79	U	0.83
20	WR8	O49	1.42	2.92	4.11	3.93	0.79	0.83
20	WR8	O50	1.39	6.00	3.91	8.00	0.75	0.79
20	WR8	O51	2.45	1.58	J	3.10	J	0.81
20	WR8	O52	2.56	5.26	4.21	20.50	0.81	0.85
20	WR8	O53	2.71	3.91	4.47	7.25	0.85	0.90
20	WR8	O54	1.82	3.84	4.10	15.70	0.78	0.82
20	WR8	O55	2.42	3.44	3.98	13.20	0.76	0.80
20	WR8	O56	2.41	5.23	3.97	8.62	0.76	0.80
		Average	1.31	4.94	2.04	10.39	0.39	0.41
		Std. Dev.	0.16	5.44	0.07	10.05	0.01	0.01

U = Analyzed, Not Detected (lower detection limit shown)

J = Present Below Detection Limits

Averages and standard deviations were calculated using J-values and one-half of the lower detection limit (U-values)

EXPLOSIVES DATA FOR WINDROWS 7 AND 8

DAY	MATERIAL	SAMPLE NUMBER	HMX (ug/g)	RDX (ug/g)	1,3,5-TNB (ug/g)	2,4,6-TNT (ug/g)	2,6-DNT (ug/g)	2,4-DNT (ug/g)
40	WR7	O30	48.30	10.20	3.88	4.04	0.74	0.78
40	WR7	O31	54.00	11.30	4.15	3.81	0.79	0.83
40	WR7	O32	53.50	12.10	4.22	7.17	0.81	0.85
40	WR7	O33	47.20	6.40	3.87	2.00	0.74	0.78
40	WR7	O34	51.80	7.72	4.49	4.13	0.86	0.90
40	WR7	O35	50.50	9.01	4.26	3.92	0.82	0.86
40	WR7	O36	49.10	5.74	3.90	2.40	0.75	0.78
40	WR7	O37	52.90	8.68	3.90	3.58	0.75	0.78
40	WR7	O38	49.50	6.68	3.97	7.19	0.76	0.80
40	WR7	O39	47.80	7.81	4.02	4.83	0.77	0.81
40	WR7	O40	48.60	7.81	4.02	4.83	0.77	0.81
40	WR7	O41	52.30	11.90	4.17	2.11	0.80	0.84
40	WR7	O42	49.60	6.82	4.01	3.69	0.77	0.81
40	WR7	O43	2.08	2.01	4.29	15.40	0.82	0.86
		Average	46.94	8.08	2.04	4.25	0.39	0.41
		Std. Dev.	13.10	2.90	0.09	3.75	0.02	0.02
40	WR8	O44	1.53	1.13	4.26	3.93	0.82	0.86
40	WR8	O45	2.68	3.82	4.41	3.02	0.84	0.89
40	WR8	O46	2.49	1.47	4.10	2.68	0.79	0.82
40	WR8	O47	2.62	2.02	4.31	2.46	0.83	0.87
40	WR8	O48	2.44	1.28	4.02	3.69	0.77	0.81
40	WR8	O49	2.42	1.87	3.99	8.44	0.76	0.80
40	WR8	O50	2.54	1.96	4.18	2.83	0.80	0.84
40	WR8	O51	1.48	1.22	4.09	1.90	0.78	0.82
40	WR8	O52	1.61	1.97	4.21	2.70	0.81	0.85
40	WR8	O53	2.52	1.92	4.15	5.80	0.79	0.83
40	WR8	O54	2.63	2.03	4.32	5.19	0.83	0.87
40	WR8	O55	2.35	1.81	3.87	3.64	0.74	0.78
40	WR8	O56	2.04	7.56	3.86	9.16	0.74	0.78
40	WR8	O57	50.70	5.14	4.32	3.97	0.83	0.87
		Average	4.91	2.10	2.07	3.97	0.40	0.42
		Std. Dev.	13.18	2.01	0.09	2.36	0.02	0.02

U = Analyzed, Not Detected (lower detection limit shown)

J = Present Below Detection Limits

Averages and standard deviations were calculated using J-values and one-half of the lower detection limit (U-values)

EXPLOSIVES DATA FOR WINDROWS 7 AND 8

DAY	MATERIAL	SAMPLE NUMBER	HMX (ug/g)	RDX (ug/g)	1,3,5-TNB (ug/g)	2,4,6-TNT (ug/g)	2,6-DNT (ug/g)	2,4-DNT (ug/g)
41	WR7	O29	41.30	5.77	3.98	3.65	0.76	0.80
41	WR7	O30	39.10	4.69	4.39	4.03	0.84	0.88
41	WR7	O31	45.70	7.43	4.15	2.45	0.79	0.83
41	WR7	O32	44.20	5.41	4.71	6.19	0.90	0.95
41	WR7	O33	37.30	4.82	4.28	3.67	0.82	0.86
41	WR7	O34	40.50	4.65	4.53	4.16	0.87	0.91
41	WR7	O35	42.60	7.77	3.93	3.61	0.75	0.79
41	WR7	O36	39.60	6.82	4.06	4.12	0.78	0.82
41	WR7	O37	46.80	21.10	3.92	3.60	0.75	0.79
41	WR7	O38	46.90	9.04	4.12	34.90	0.79	0.83
41	WR7	O39	39.80	4.55	4.04	2.21	0.77	0.81
41	WR7	O40	39.70	6.75	4.07	3.73	0.78	0.82
41	WR7	O41	44.20	5.84	4.24	4.66	0.81	0.85
41	WR7	O42	50.40	5.27	4.25	3.91	0.81	0.85
		Average	42.72	7.14	2.10	5.11	0.40	0.42
		Std. Dev.	3.75	4.24	0.11	8.68	0.02	0.02
41	WR8	O43	1.26	4.63	4.01	10.10	0.77	0.81
41	WR8	O44	2.73	1.17	4.49	4.13	0.86	0.90
41	WR8	O45	2.71	1.37	4.46	4.10	0.85	0.90
41	WR8	O46	2.54	1.78	4.18	3.84	0.80	0.84
41	WR8	O47	1.50	1.54	4.23	2.05	0.81	0.85
41	WR8	O48	2.57	1.00	4.24	3.89	0.81	0.85
41	WR8	O49	2.41	1.86	3.97	2.75	0.76	0.80
41	WR8	O50	2.15	1.80	4.64	3.15	0.89	0.93
41	WR8	O51	2.53	1.95	4.16	8.62	0.80	0.84
41	WR8	O52	2.37	1.03	3.90	3.58	0.75	0.78
41	WR8	O53	2.42	2.67	3.99	106.00	0.76	0.80
41	WR8	O54	2.51	2.15	4.13	2.14	0.79	0.83
41	WR8	O55	2.40	1.85	3.95	3.63	0.76	0.79
41	WR8	O56	2.74	2.12	4.52	5.90	0.86	0.91
		Average	1.62	1.65	2.10	10.88	0.40	0.42
		Std. Dev.	0.56	1.01	0.12	27.51	0.02	0.02

U = Analyzed, Not Detected (lower detection limit shown)

J = Present Below Detection Limits

Averages and standard deviations were calculated using J-values and one-half of the lower detection limit (U-values)

EXPLOSIVES DATA FOR WINDROWS 7 AND 8

DAY	MATERIAL	SAMPLE NUMBER	HMX (ug/g)	RDX (ug/g)	1,3,5-TNB (ug/g)	2,4,6-TNT (ug/g)	2,6-DNT (ug/g)	2,4-DNT (ug/g)
53	WR7	O15	6.95	1.98	U	3.87	U	0.85
53	WR7	O16	5.44	1.00	U	3.68	U	0.80
53	WR7	O17	5.78	2.08	U	4.07	U	0.89
53	WR7	O18	5.72	2.06	U	4.04	U	0.88
53	WR7	O19	5.26	1.98	U	3.87	U	0.85
53	WR7	O20	5.47	2.04	U	3.99	U	0.87
53	WR7	O21	7.74	1.21	J	13.50	U	0.84
53	WR7	O22	5.06	1.97	U	3.85	U	0.84
53	WR7	O23	8.91	2.50	U	3.68	U	0.80
53	WR7	O24	6.83	1.89	U	3.69	U	0.81
53	WR7	O25	5.15	1.88	U	2.24	J	0.80
53	WR7	O26	10.20	1.81	U	3.55	U	0.78
53	WR7	O27	8.41	1.83	U	3.58	U	0.78
53	WR7	O28	8.77	1.94	U	3.79	U	0.83
		Average	6.84	1.10		2.76		0.42
		Std. Dev.	1.69	0.41		3.09		0.02
53	WR8	O15	2.54	1.96	U	3.83	U	0.84
53	WR8	O16	2.57	1.98	U	3.88	U	0.85
53	WR8	O17	2.50	1.93	U	5.78	U	0.83
53	WR8	O18	2.52	1.84	J	3.81	U	0.83
53	WR8	O19	2.50	1.93	U	3.79	U	0.83
53	WR8	O20	2.53	1.28	U	3.83	U	0.84
53	WR8	O21	3.73	45.30	U	111.00	U	0.85
53	WR8	O22	2.56	2.08	U	5.70	U	0.85
53	WR8	O23	2.53	1.96	U	3.83	U	0.84
53	WR8	O24	2.57	1.99	U	7.90	U	0.85
53	WR8	O25	2.55	3.47	U	8.68	U	0.84
53	WR8	O26	2.54	6.48	U	7.61	U	0.84
53	WR8	O27	1.66	5.59	J	13.90	U	0.84
53	WR8	O28	2.56	3.95	U	17.90	U	0.85
		Average	1.47	5.37		13.57		0.42
		Std. Dev.	0.66	11.64		28.48		0.00

U = Analyzed, Not Detected (lower detection limit shown)
 J = Present Below Detection Limits
 Averages and standard deviations were calculated using J-values and one-half of the lower detection limit (U-values)

INTERMEDIATES DATA FOR WINDROWS 7 AND 8 (All values in ug/g)

DAY	MATERIAL	SAMPLE NUMBER	2,4-Diamino-6-Nitrotoluene	4-Amino-2,6-Dinitrotoluene	2,6-Diamino-4-Nitrotoluene	2-Amino-4,6-Dinitrotoluene
	Clamshell Floor	OO1	25.90	31.00	25.90	18.00
0	CWR7	O77	100.00	1000.00	100.00	360.00
0	CWR7	O78	102.00	230.00	102.00	120.00
0	CWR7	O79	34.00	420.00	103.00	190.00
0	CWR7	O80	102.00	710.00	102.00	270.00
0	CWR7	O81	99.70	180.00	99.70	100.00
0	CWR7	O82	102.00	34.00	102.00	29.00
0	CWR7	O82 RE	25.40	35.00	25.40	28.00
0	CWR7	O83	102.00	550.00	102.00	280.00
0	CWR7	O84	102.00	110.00	102.00	67.00
0	CWR7	O85	103.00	81.00	103.00	62.00
0	CWR7	O85 RE	25.80	96.00	25.80	72.00
0	CWR7	O86	102.00	360.00	102.00	200.00
0	CWR7	O87	101.00	66.00	101.00	50.00
0	CWR7	O87 RE	25.20	81.00	25.20	60.00
0	CWR7	O88	28.00	140.00	102.00	110.00
0	CWR7	O89	103.00	150.00	103.00	98.00
0	CWR7	O90	102.00	24.00	102.00	34.00
0	CWR7	O90 RE	11.00	33.00	25.60	45.00
		Average	40.09	238.89	42.44	120.83
		Std. Dev.	16.57	271.77	16.33	98.43
0	CWR8	O91	100.00	33.00	100.00	33.00
0	CWR8	O91 RE	10.00	44.00	25.00	43.00
0	CWR8	O92	102.00	670.00	102.00	280.00
0	CWR8	O93	102.00	580.00	102.00	320.00
0	CWR8	O94	101.00	370.00	101.00	170.00
0	CWR8	O95	36.00	770.00	102.00	370.00
0	CWR8	O96	20.00	490.00	101.00	220.00
0	CWR8	O97	101.00	21.00	101.00	20.00
0	CWR8	O97 RE	25.20	33.00	25.20	32.00
0	CWR8	O98	101.00	350.00	101.00	180.00
0	CWR8	O99	101.00	160.00	101.00	81.00

U = Analyzed, Not Detected (lower detection limit shown)

J = Present Below Detection Limits

Averages and standard deviations were calculated using J-values and one-half of the lower detection limit (U-values)

INTERMEDIATES DATA FOR WINDROWS 7 AND 8 (All values in ug/g)

DAY	MATERIAL	SAMPLE NUMBER	2,4-Diamino-6-Nitrotoluene	4-Amino-2,6-Dinitrotoluene	2,6-Diamino-4-Nitrotoluene	2-Amino-4,6-Dinitrotoluene
0	CWR8	O100	101.00	U	J	U
0	CWR8	O100 RE	7.90	J		60.00
0	CWR8	O101	25.50	U		74.00
0	CWR8	O102	25.00	U		120.00
0	CWR8	O103	101.00	U	J	U
0	CWR8	O104	101.00	U	J	U
0	CWR8	O104 RE	5.70	J		91.00
		Average	34.61			127.67
		Std. Dev.	19.35			106.70
5	CWR7	105	26.50	U		U
5	CWR7	106	25.90	U		72.00
5	CWR7	107	25.40	U		58.00
5	CWR7	108	25.70	U		52.00
5	CWR7	109	25.50	U		57.00
5	CWR7	110	25.50	U		86.00
5	CWR7	111	25.80	U		59.00
5	CWR7	112	25.90	U		59.00
5	CWR7	113	25.00	U		63.00
5	CWR7	114	25.50	U		68.00
5	CWR7	115	26.10	U		79.00
5	CWR7	116	25.30	U		75.00
5	CWR7	117	25.80	U		81.00
5	CWR7	118	26.90	U		67.00
		Average	12.89			68.00
		Std. Dev.	0.25			10.41
5	CWR8	119	18.00	J		U
5	CWR8	119 RE	25.60	U		99.00
5	CWR8	120	14.00	J		100.00
5	CWR8	120 RE	25.40	U		73.00
5	CWR8	121	13.00	J		69.00
5	CWR8	121 RE	25.70	U		130.00
5	CWR8	122	27.00	U		64.00
		Average	12.89			68.00
		Std. Dev.	0.25			10.41

U = Analyzed, Not Detected (lower detection limit shown)

J = Present Below Detection Limits

Averages and standard deviations were calculated using J-values and one-half of the lower detection limit (U-values)

INTERMEDIATES DATA FOR WINDROWS 7 AND 8 (All values in ug/g)

DAY	MATERIAL	SAMPLE NUMBER	2,4-Diamino-6-Nitrotoluene	4-Amino-2,6-Dinitrotoluene	2,6-Diamino-4-Nitrotoluene	2-Amino-4,6-Dinitrotoluene
5	CWR8	122 RE	26.00	200.00	26.00	U
5	CWR8	123	26.90	43.00	26.90	U
5	CWR8	124	27.20	46.00	27.20	U
5	CWR8	125	25.90	38.00	25.90	U
5	CWR8	126	25.20	35.00	25.20	U
5	CWR8	127	26.00	34.00	26.00	U
5	CWR8	128	25.60	30.00	25.60	U
5	CWR8	129	26.10	33.00	26.10	U
5	CWR8	130	26.20	35.00	26.20	U
5	CWR8	131	11.00	110.00	8.40	J
5	CWR8	132	11.00	61.00	7.20	J
		Average	13.88	90.39	13.84	
		Std. Dev.	3.57	71.42	4.49	
10	WR7	O29	5.90	38.00	25.60	U
10	WR7	O30	9.90	63.00	25.70	U
10	WR7	O31	6.30	100.00	25.60	U
10	WR7	O32	5.60	52.00	25.50	U
10	WR7	O33	8.50	120.00	25.60	U
10	WR7	O34	5.40	81.00	25.60	U
10	WR7	O35	5.60	110.00	25.60	U
10	WR7	O36	11.00	140.00	6.80	J
10	WR7	O37	8.00	180.00	5.20	J
10	WR7	O38	7.10	65.00	25.60	U
10	WR7	O39	11.00	110.00	25.10	U
10	WR7	O40	6.10	41.00	25.80	U
10	WR7	O41	15.00	140.00	25.40	U
10	WR7	O42	6.40	150.00	25.20	U
		Average	7.99	99.29	11.80	
		Std. Dev.	2.82	44.10	2.48	
10	WR8	O43	53.00	100.00	12.00	J
10	WR8	O44	19.00	110.00	17.00	J
10	WR8	O45	14.00	190.00	21.00	J

U = Analyzed, Not Detected (lower detection limit shown)

J = Present Below Detection Limits

Averages and standard deviations were calculated using J-values and one-half of the lower detection limit (U-values)

INTERMEDIATES DATA FOR WINDROWS 7 AND 8 (All values in ug/g)

DAY	MATERIAL	SAMPLE NUMBER	2,4-Diamino-6-Nitrotoluene	4-Amino-2,6-Dinitrotoluene	2,6-Diamino-4-Nitrotoluene	2-Amino-4,6-Dinitrotoluene
10	WR8	O46	17.00	J	18.00	J
10	WR8	O47	65.00		62.00	
10	WR8	O48	55.00		44.00	
10	WR8	O49	37.00		31.00	J
10	WR8	O50	19.00	J	24.00	J
10	WR8	O51	16.00	J	350.00	J
10	WR8	O52	31.00		170.00	
10	WR8	O53	13.00	J	58.00	J
10	WR8	O54	36.00	J	140.00	J
10	WR8	O55	5.90	J	20.00	J
10	WR8	O56	6.80	J	29.00	J
		Average	27.69		130.93	19.04
		Std. Dev.	18.94		90.61	7.73
15	WR7	O29	1.00	J	22.00	J
15	WR7	O30	2.10	J	36.00	J
15	WR7	O31	4.91	U	19.00	U
15	WR7	O32	5.01	U	23.00	U
15	WR7	O33	4.86	U	38.00	J
15	WR7	O34	5.04	U	34.00	J
15	WR7	O35	5.03	U	30.00	J
15	WR7	O36	4.80	U	35.00	J
15	WR7	O37	5.05	U	26.00	J
15	WR7	O38	4.91	U	36.00	J
15	WR7	O39	5.09	U	25.00	J
15	WR7	O40	4.90	U	29.00	J
15	WR7	O41	5.11	U	30.00	J
15	WR7	O42	4.92	U	43.00	J
		Average	2.35		30.43	2.71
		Std. Dev.	0.40		6.90	0.52
15	WR8	O43	4.69	U	9.10	J
15	WR8	O44	4.84	U	5.10	J
15	WR8	O45	5.19	U	5.30	J

U = Analyzed, Not Detected (lower detection limit shown)

J = Present Below Detection Limits

Averages and standard deviations were calculated using J-values and one-half of the lower detection limit (U-values)

INTERMEDIATES DATA FOR WINDROWS 7 AND 8 (All values in ug/g)

DAY	MATERIAL	SAMPLE NUMBER	2,4-Diamino-6-Nitrotoluene	4-Amino-2,6-Dinitrotoluene	2,6-Diamino-4-Nitrotoluene	2-Amino-4,6-Dinitrotoluene
15	WR8	O46	5.07	U	7.10	U
15	WR8	O47	4.87	U	7.00	U
15	WR8	O48	4.98	U	3.80	J
15	WR8	O49	4.97	U	8.80	U
15	WR8	O50	5.01	U	7.40	U
15	WR8	O51	4.88	U	7.90	U
15	WR8	O52	5.15	U	9.60	U
15	WR8	O53	4.93	U	4.60	J
15	WR8	O54	4.87	U	5.90	U
15	WR8	O55	4.87	U	6.80	U
15	WR8	O56	4.77	U	4.20	J
		Average	2.47		6.61	
		Std. Dev.	0.07		1.86	
20	WR7	O29	4.69	U	6.00	U
20	WR7	O30	4.91	U	6.40	U
20	WR7	O31	1.80	J	9.30	U
20	WR7	O32	1.30	J	7.90	U
20	WR7	O33	1.60	J	5.80	U
20	WR7	O34	1.10	J	5.20	U
20	WR7	O35	1.40	J	8.20	U
20	WR7	O36	1.30	J	5.30	U
20	WR7	O37	1.20	J	8.20	U
20	WR7	O38	1.10	J	5.20	U
20	WR7	O39	5.01	U	5.90	U
20	WR7	O40	4.76	U	13.00	U
20	WR7	O41	5.07	U	8.80	U
20	WR7	O42	5.06	U	13.00	U
		Average	1.83		7.73	
		Std. Dev.	0.60		2.63	
20	WR8	O43	5.04	U	2.10	U
20	WR8	O44	4.68	U	1.70	U
20	WR8	O45	5.02	U	1.90	U

U = Analyzed, Not Detected (lower detection limit shown)

J = Present Below Detection Limits

Averages and standard deviations were calculated using J-values and one-half of the lower detection limit (U-values)

INTERMEDIATES DATA FOR WINDROWS 7 AND 8 (All values in ug/g)

DAY	MATERIAL	SAMPLE NUMBER	2,4-Diamino-6-Nitrotoluene	4-Amino-2,6-Dinitrotoluene	2,6-Diamino-4-Nitrotoluene	2-Amino-4,6-Dinitrotoluene
20	WR8	O46	4.96	U	J	U
20	WR8	O47	5.01	U	J	U
20	WR8	O48	4.69	U	J	U
20	WR8	O49	5.31	U	J	U
20	WR8	O50	4.68	U	J	J
20	WR8	O51	5.06	U	J	U
20	WR8	O52	4.96	U	J	U
20	WR8	O53	4.93	U	U	U
20	WR8	O54	5.02	U	J	U
20	WR8	O55	5.15	U	J	U
20	WR8	O56	5.08	U	J	U
		Average	2.49		2.21	1.81
		Std. Dev.	0.09		0.52	0.70
40	WR7	O30	5.15	U	9.90	U
40	WR7	O31	5.10	U	5.10	U
40	WR7	O32	5.09	U	8.00	U
40	WR7	O33	5.04	U	5.04	U
40	WR7	O34	5.05	U	5.05	U
40	WR7	O35	5.00	U	11.00	U
40	WR7	O36	5.06	U	5.06	U
40	WR7	O37	5.02	U	1.10	U
40	WR7	O38	5.02	U	6.60	U
40	WR7	O39	5.09	U	5.09	U
40	WR7	O40	4.98	U	12.00	U
40	WR7	O41	5.13	U	1.40	U
40	WR7	O42	5.09	U	2.10	U
40	WR7	O43	5.24	U	5.24	U
		Average	2.54		4.81	2.11
		Std. Dev.	0.03		3.85	0.63
40	WR8	O44	5.30	U	3.30	U
40	WR8	O45	5.14	U	3.30	U
40	WR8	O46	5.10	U	5.10	U

U = Analyzed, Not Detected (lower detection limit shown)

J = Present Below Detection Limits

Averages and standard deviations were calculated using J-values and one-half of the lower detection limit (U-values)

INTERMEDIATES DATA FOR WINDROWS 7 AND 8 (All values in ug/g)

DAY	MATERIAL	SAMPLE NUMBER	2,4-Diamino-6-Nitrotoluene	4-Amino-2,6-Dinitrotoluene	2,6-Diamino-4-Nitrotoluene	2-Amino-4,6-Dinitrotoluene
40	WR8	O47	5.20	U	J	5.20
40	WR8	O48	5.05	U	J	5.05
40	WR8	O49	5.10	U	J	5.10
40	WR8	O50	5.12	U	J	5.12
40	WR8	O51	5.22	U	J	5.22
40	WR8	O52	5.38	U	J	5.38
40	WR8	O53	5.18	U	J	5.18
40	WR8	O54	5.03	U	J	5.03
40	WR8	O55	5.11	U	J	5.11
40	WR8	O56	5.07	U	J	5.07
40	WR8	O57	5.11	U	J	2.60
		Average	2.58			2.58
		Std. Dev.	0.05			0.05
40	Floor Sample	O58	5.13	U		5.13
						21.00

U = Analyzed, Not Detected (lower detection limit shown)
 J = Present Below Detection Limits
 Averages and standard deviations were calculated using J-values and one-half of the lower detection limit (U-values)

OXYGEN DEPLETION DATA FOR UWR2

TIME(min.)	DATE: 6/6/92	DATE: 6/7/92
	O2 (%)	O2 (%)
0	15.6	11.8
1	15.3	10.8
2	15.1	10
3	14.6	9.1
4	13.9	8.5
5	13.6	7.7
6	13.2	7.1
7	12.4	6.5
8	12.3	5.6
9	12.1	5
10	11.9	4.4
11	11	4
12	10.8	3.6
13	10.3	3.3
14	10.1	3.1
15	9.7	3
16	9.3	2.6
17	9	2.3
18	8.5	2.2
19	8.2	1.9
20	7.7	1.8
21	7.3	1.7
22	7.1	1.6
23	7.1	1.4
24	7.3	1.3
25	6.7	1.2
26	6.3	1.1
27	6	1
28	5.6	0.9
29	5.4	0.8
30	5.1	0.8
31	4.8	0.7
32	4.6	0.7
33	4.7	0.6
34	4.4	0.6
35	4.3	0.5
36	4.2	0.5
37	4	0.5
38	3.8	0.4
39	3.7	0.4
40	3.6	0.3
41	3.4	0.3
42	3.3	0.3
43	3.1	0.3
44	2.9	0.3
45	2.7	0.2
46	2.6	0.2
47	2.7	0.2
48	2.8	0.2
49	2.6	0.2
50	2.5	0.2
51	2.4	
52	2.2	
53	2.1	
54	2.1	
55	2.1	
56	1.5	
57	1.4	
58	1.4	
59	1.2	
60	1.2	

APPENDIX G
GRAPHICAL PRESENTATION OF TNT REMOVAL KINETICS
AND REGRESSION RESULTS

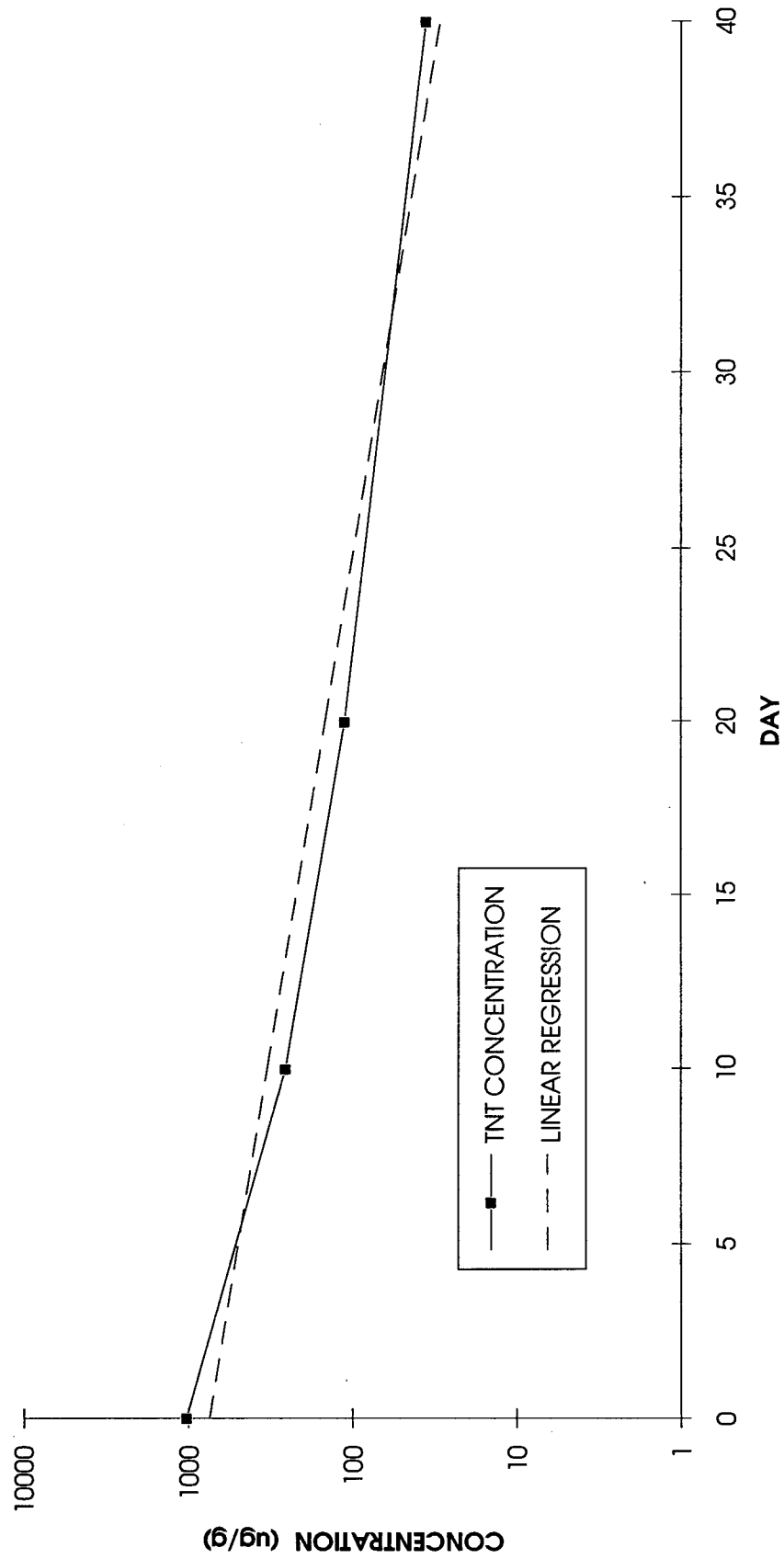

CONTROL REACTOR A KINETIC DATA BASED ON TNT

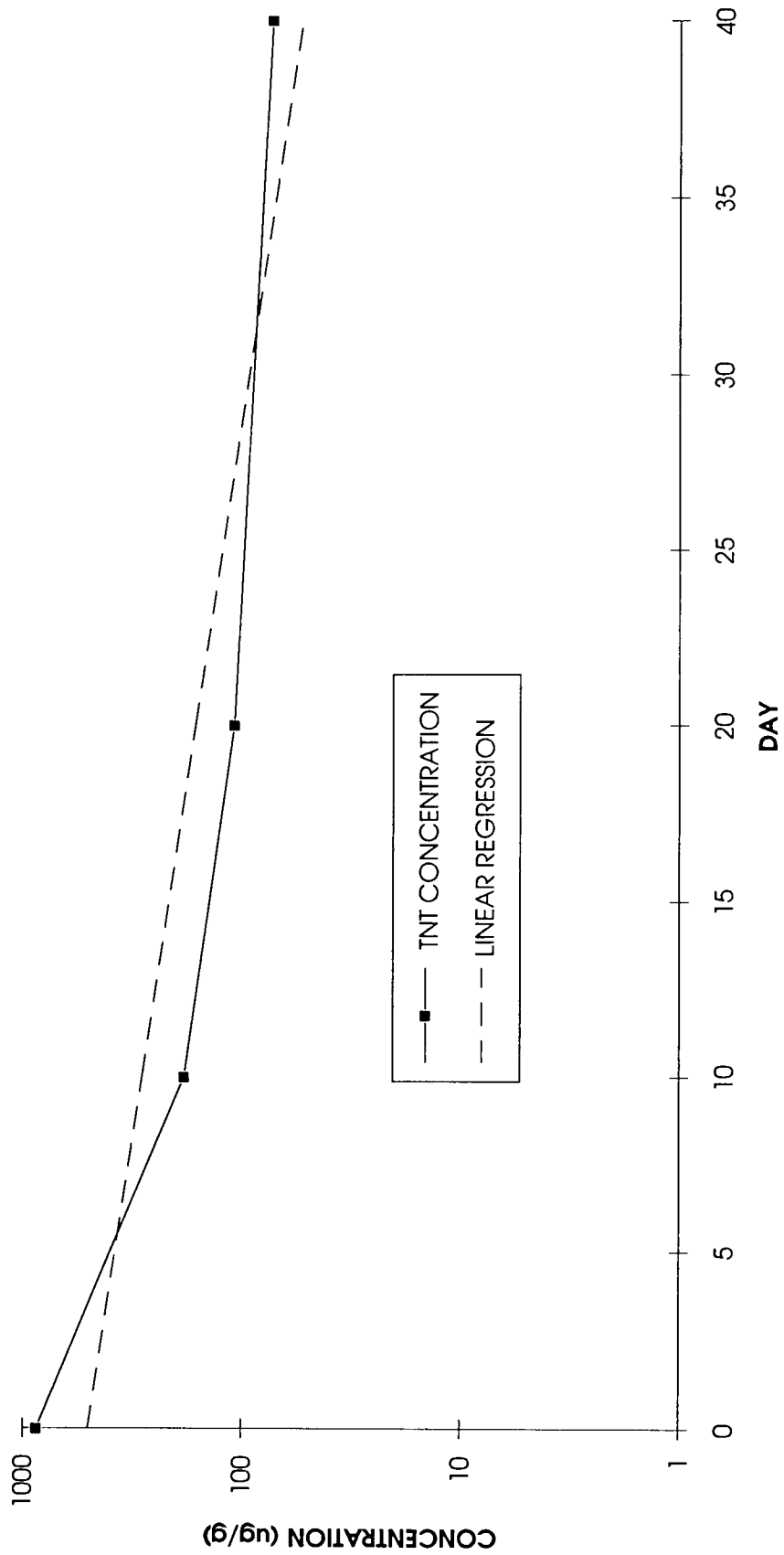

SEED REACTOR A KINETIC DATA BASED ON TNT

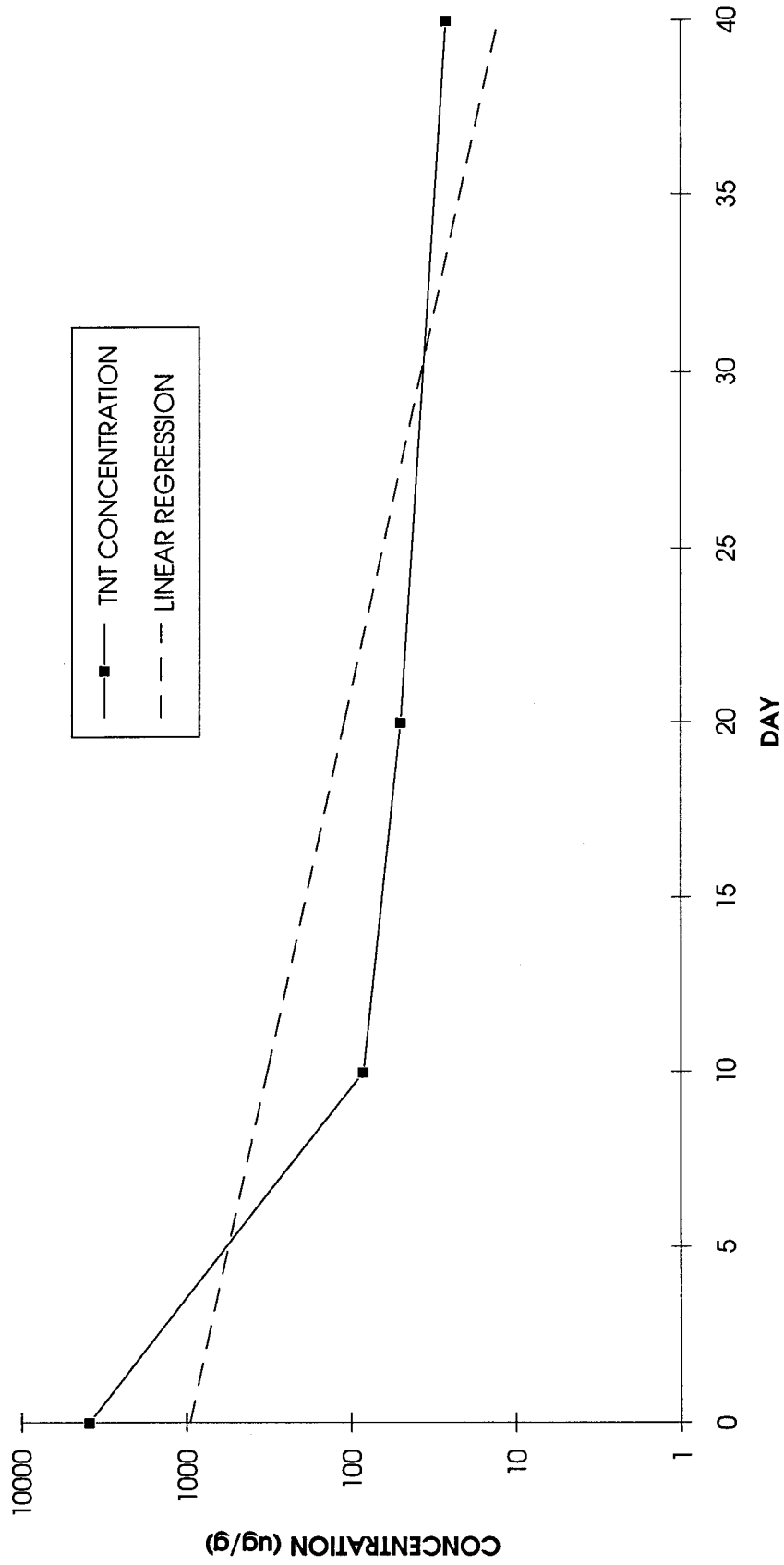

CONTROL REACTOR B KINETIC DATA BASED ON TNT

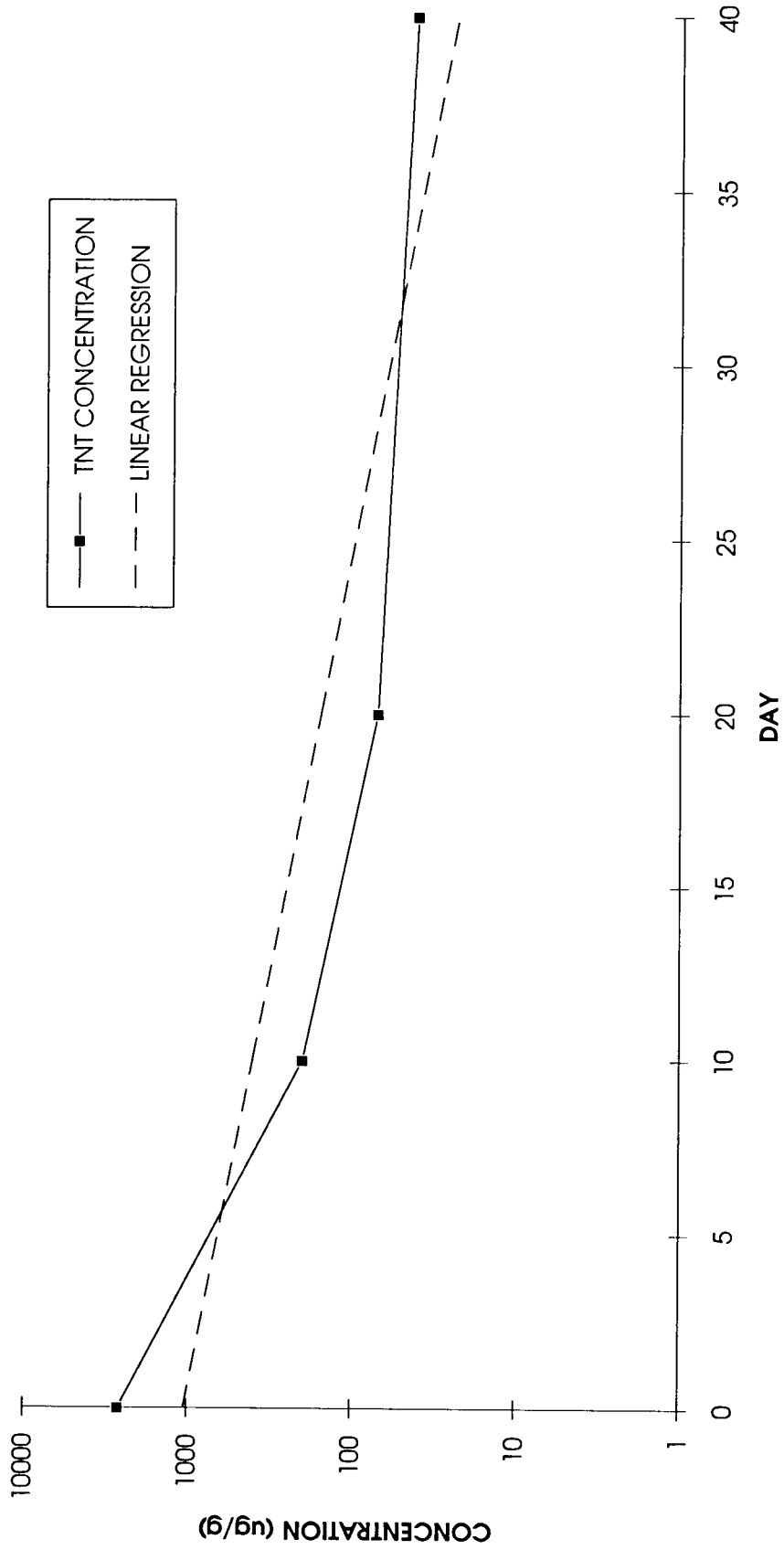

SEED REACTOR B KINETIC DATA BASED ON TNT

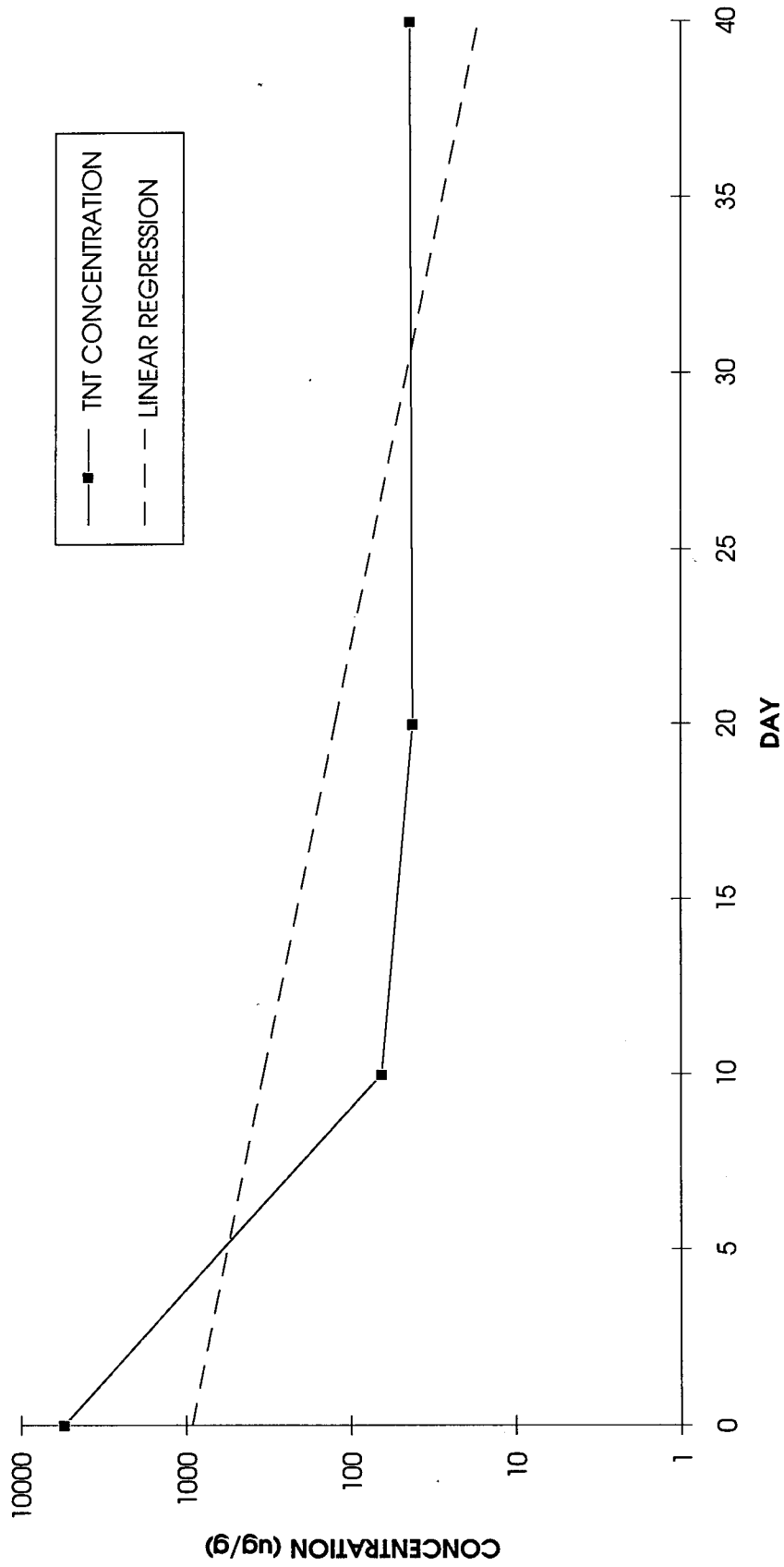

CONTROL REACTOR C KINETIC DATA BASED ON TNT

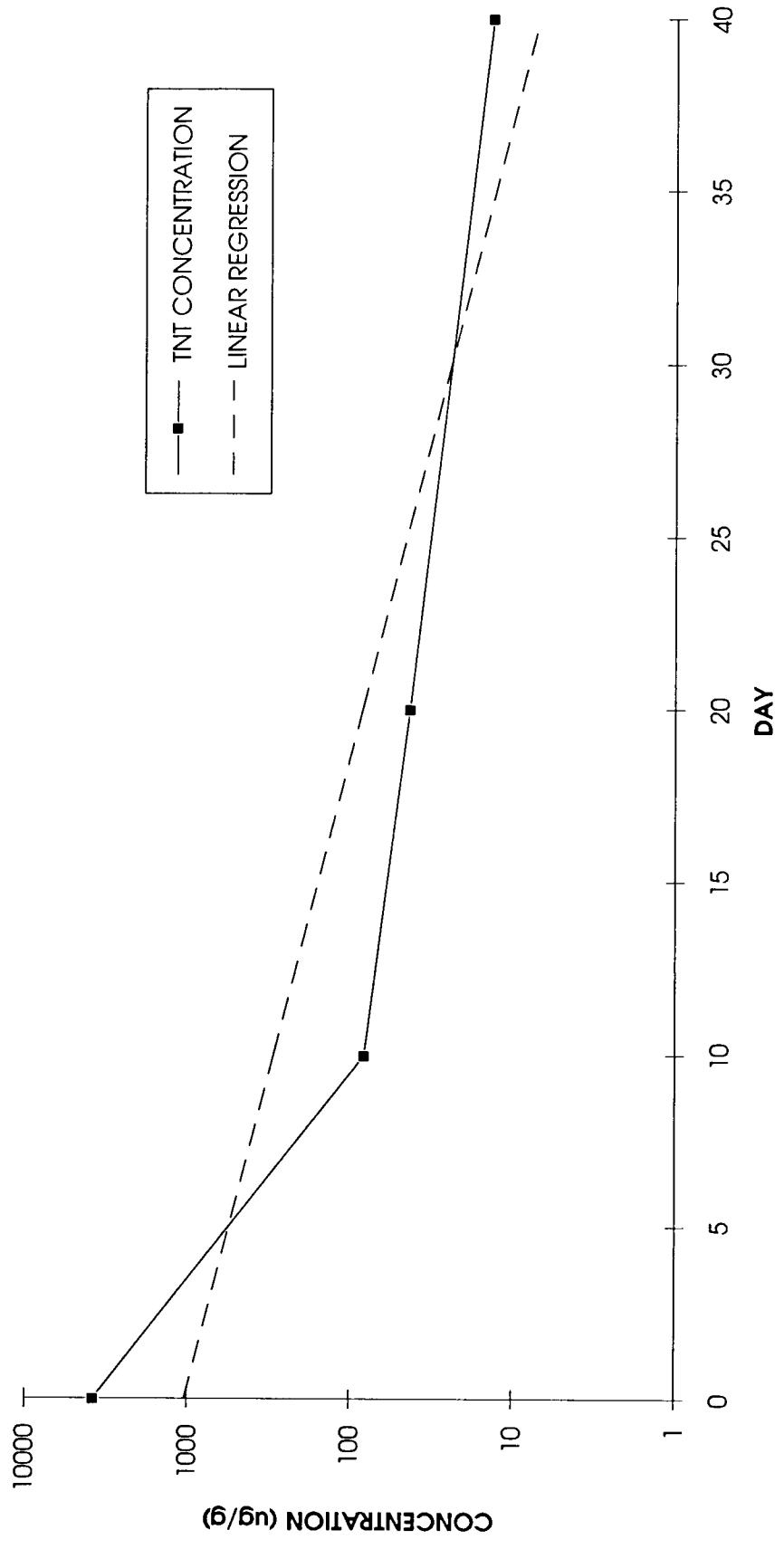

SEED REACTOR C KINETIC DATA BASED ON TNT

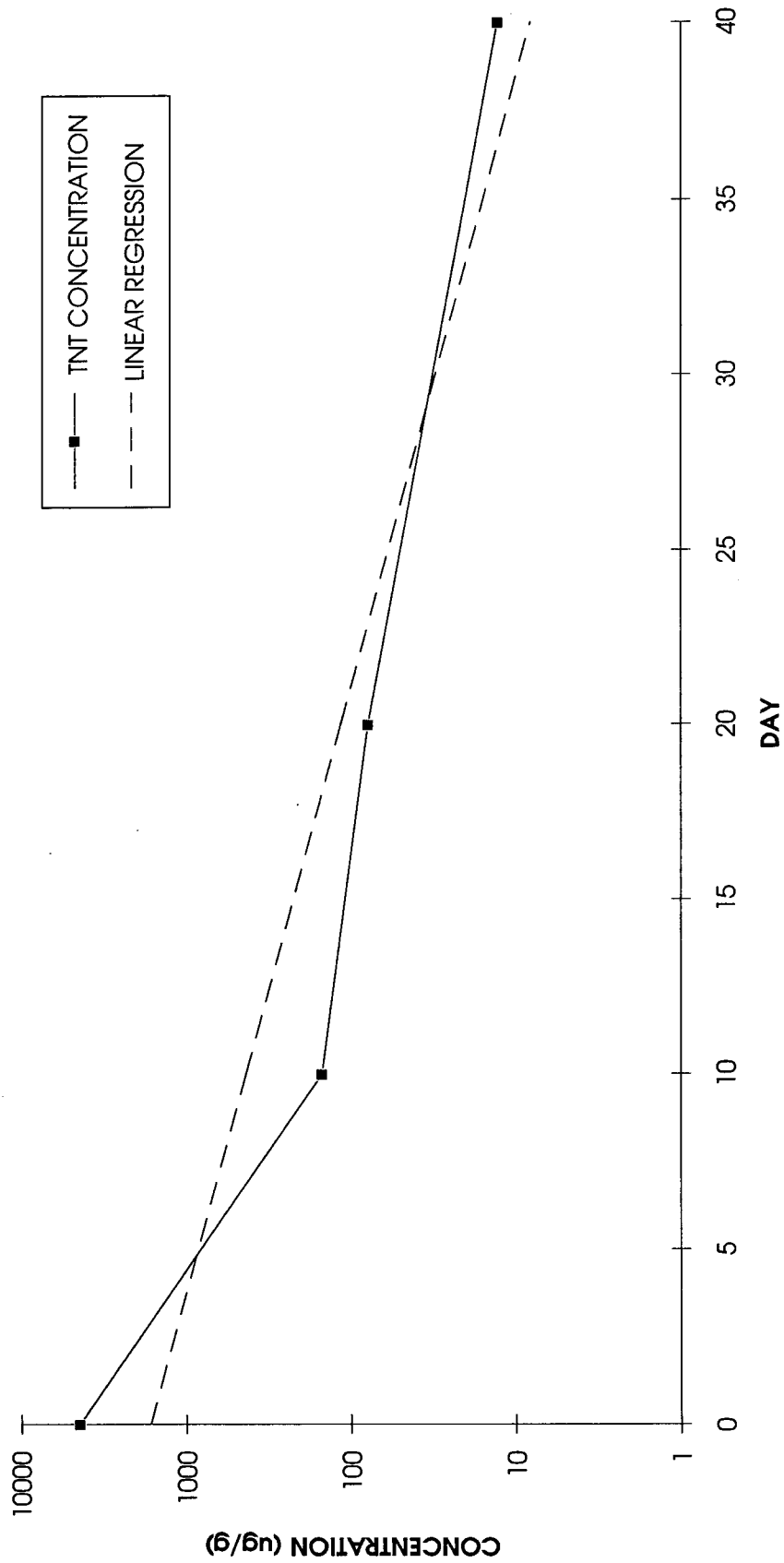

CONTROL REACTOR D KINETIC DATA BASED ON TNT

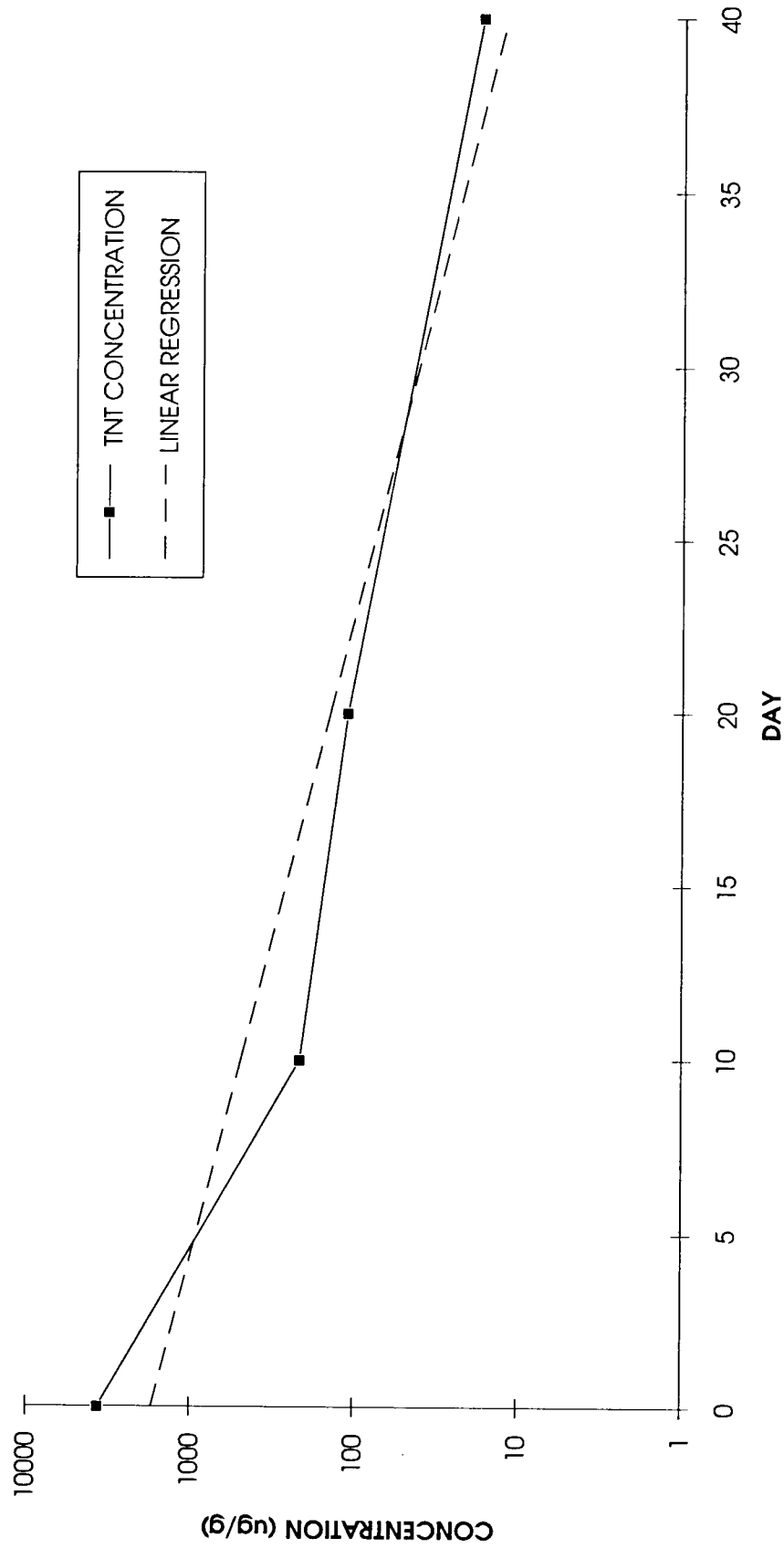

SEED REACTOR D KINETIC DATA BASED ON TNT

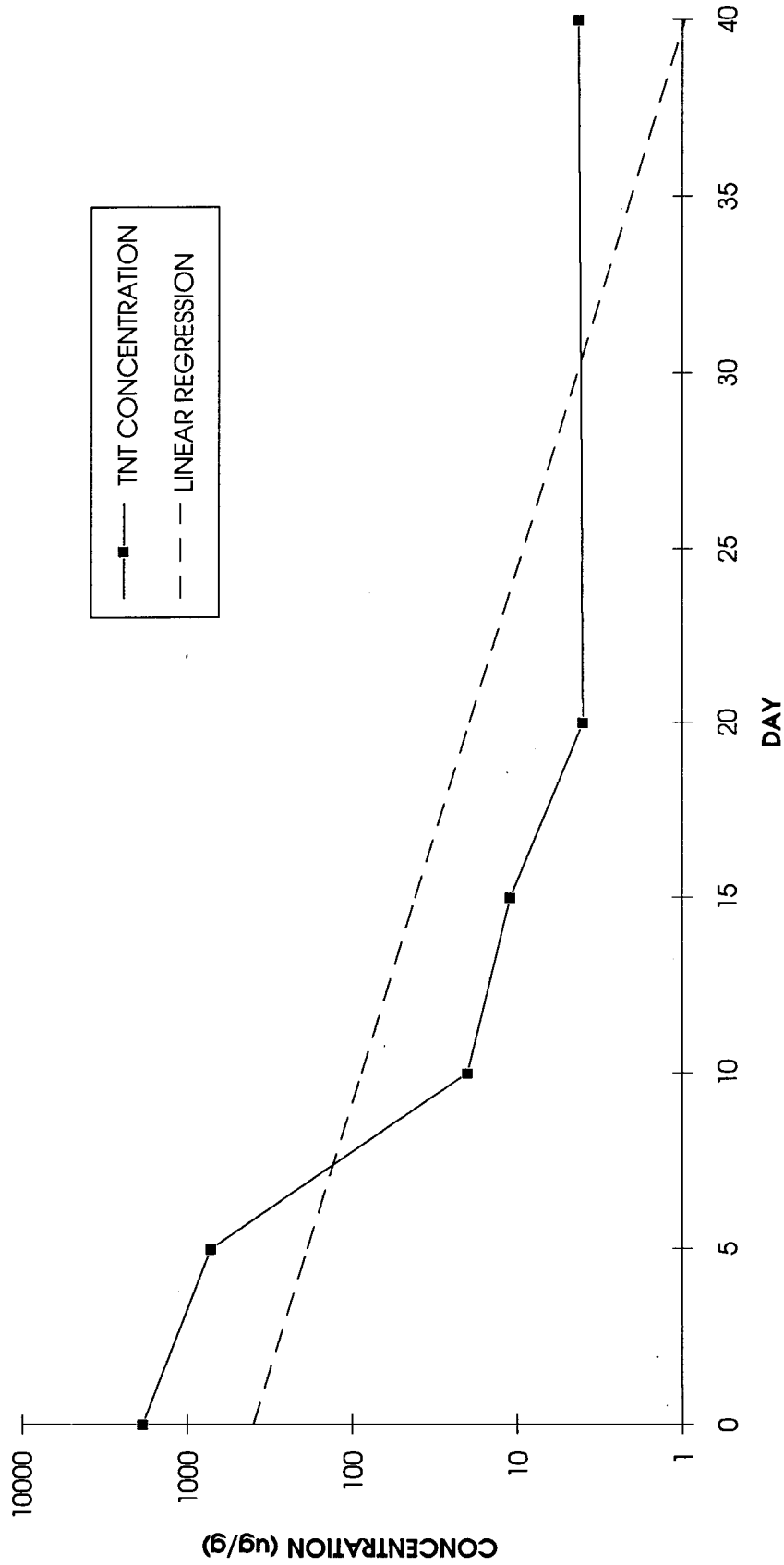

AERATED, CONTAMINATED WINDROW (CWR7) KINETIC DATA BASED ON TNT

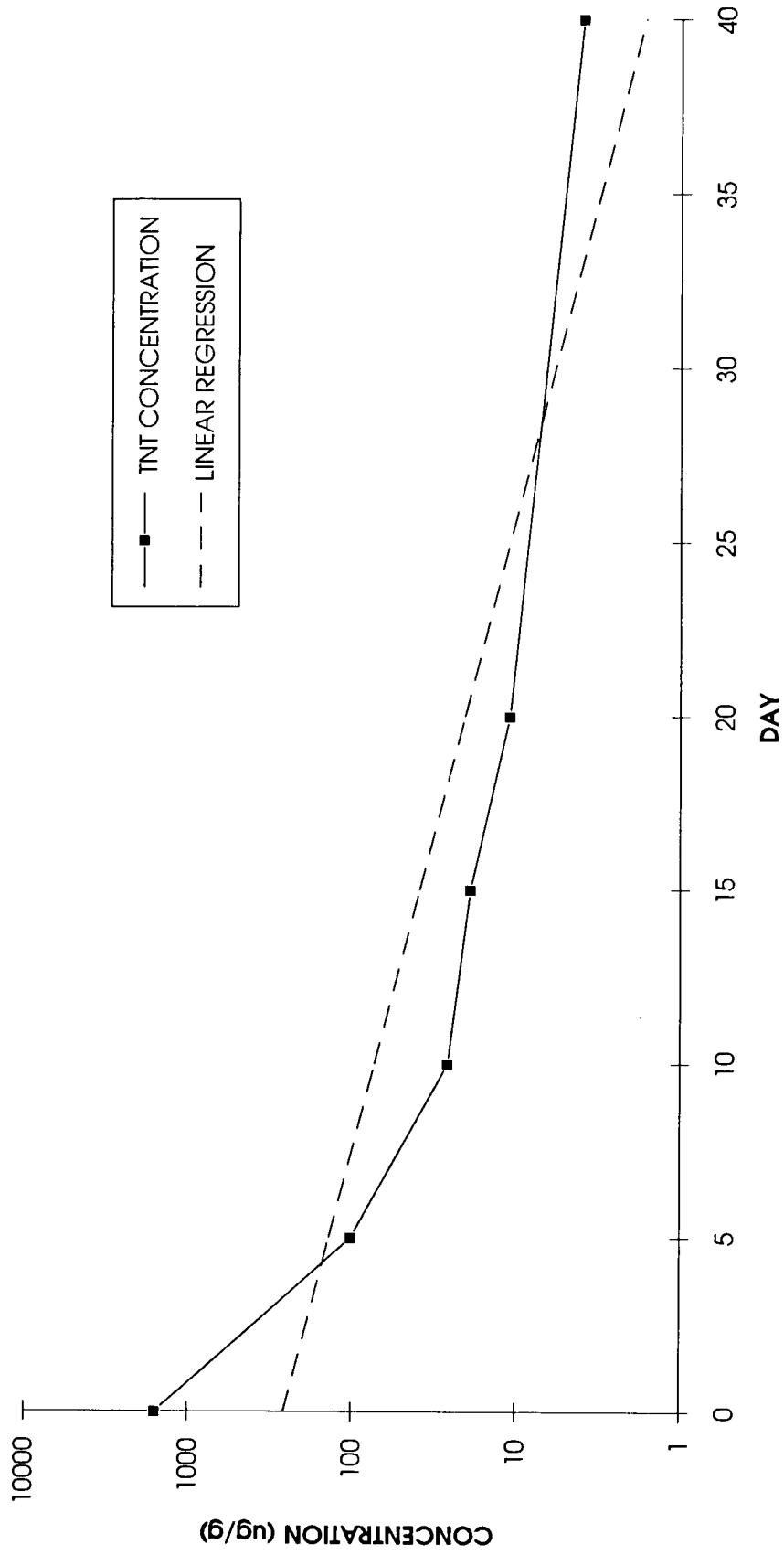

UNAERATED, CONTAMINATED WINDROW (CWR8) KINETIC DATA BASED ON TNT



APPENDIX H

COMPARISON OF EPA SW846 DRAFT METHOD 8330 AND USATHAMA METHOD LW02



USAEC
EXPLOSIVES ANALYTICAL METHODS COMPARISON

Purpose: To provide a direct comparison between USATHAMA Method LW02 and USEPA Method 8330 for the analysis of explosives in milled compost samples.

Test Matrix: The comparison test used milled compost samples from the contaminated, unaerated windrow (CWR8) in the UMDA field demonstration. These samples were taken during windrow operation (October-November 1992). Samples were dried, milled, and analyzed in accordance with the approved Test Plan. The remaining sample volumes were stored at WESTON's Lionville Analytics Laboratory in amber jars at 4°C since receipt.

Approach: This test examined the agreement between the selected methods on samples from two (2) different time points in the compost process. Based upon previous analytical data, explosives levels in these samples may vary over 2 orders of magnitude. Since all samples were dried and milled prior to analysis, the physical consistency of all samples was expected to be similar.

The most critical determination in terms of full-scale application is whether the final compost residue meets specified explosives criteria as was indicated by the results achieved for the samples taken during the field demonstration. Therefore, final (day 40) samples were analyzed in four replicates, consistent with USEPA SW846 requirements to establish analytical precision and accuracy. Samples from day 0 were also analyzed in four duplicates to provide an assessment of differences in performance over the composting cycle.

Because of the elapsed time since the previous analyses as well as other potential variability, the previous data were not used as a basis for this comparison. Each selected sample was analyzed by each method (LW02 and 8330).

Methods: USATHAMA Method LW02, as modified and used in the Composting Study, was used in this test. USEPA Method 8330 was used for comparison. For each method, samples were analyzed for TNT, HMX, RDX, TNB, 2,4-DNT, and 2,6-DNT. The goal was to evaluate differences in reported concentrations which result solely from the extraction procedure itself. Therefore, to the maximum extent possible, USEPA Method 8330 sample preparation was the same as Modified Method LW02, including those modifications where possible. The major difference between the two methods is the length of time allotted for solvent extraction: Method LW02 uses a 2-minute shake extraction, while Method 8330 uses an 18-hour sonication.

Results: The samples identified for the method comparison were extracted by both the USATHAMA LW02 technique (2-minute hand shaking) and the

USEPA 8330 technique (18-hour sonication). Extractions for both techniques were initiated at the same time using identical sample weights and solvent volumes (e.g., 10 grams and 40 mL of acetonitrile), so that the only variable for the preparation was the method of ensuring contact between the extraction solvent and the sample material. To eliminate any bias introduced by drift in the instrument's response during the analysis, all extracts were analyzed within the same analytical sequence at identical dilutions, with the extracts of a particular sample at a particular dilution by Method LW02 followed immediately by the same sample's Method 8330 extract at the same dilution. Results from both methods were reported from the same dilution factors to eliminate any bias introduced by any response differences at the low levels of the calibration curve. This yielded several "J" values because of the laboratory's different reporting levels for the two methods, but it does provide the best direct comparison of the two methods.

The average results obtained from the analysis are summarized in Table 1. These results reflect a consistently low bias for Method LW02 relative to Method 8330. The differences are more pronounced with the compounds at concentration levels less than 10 $\mu\text{g/g}$, with differences ranging from 8% to 59%. The differences in the means for results greater than 100 $\mu\text{g/g}$ were 18% or less.

To determine if there were any statistically significant differences in the two methods, a paired "t" test was applied to the results (Table 2). For the six pairs of results at concentrations less than 10 $\mu\text{g/g}$, the "t" test indicated that there was a significant difference (at the 99% confidence limit) between the methods with three of the comparisons. With the exception of TNT for sample W8-40-8, these significant differences were all associated with nitroaromatic compounds. There were no significant differences in the results for the nitramines (HMX and RDX) below 10 $\mu\text{g/g}$ or above 200 $\mu\text{g/g}$ (note: the t test was performed on only one set of results above 200 $\mu\text{g/g}$. Results for HMX and RDX at these levels did not yield standard deviations, as reported results for all four replicates were identical).

In general, it would appear that some degree of low bias would usually be obtained with the LW02 extraction method relative to the 8330 method. The paired t test indicated there was a significant difference with 50% of the results obtained below 10 $\mu\text{g/g}$. Consequently, when evaluating low-level results with respect to required clean-up levels, some degree of correction may be appropriate to ensure that the results obtained by the LW02 analysis would actually reflect that the desired level of remediation has been achieved.

Table 1

Sample = W8-1-8 Compost Samples - Day 1 (units = $\mu\text{g/g}$)

<u>Method</u>		<u>HDX</u>	<u>RDX</u>	<u>TNB</u>	<u>TNT</u>	<u>2,6-DNT</u>	<u>2,4-DNT</u>
LW02	Avg.	210	1,300	2.0	1,800	ND	2.2
	S(n-1)	12.6	81.6	0.13	95.7		0.17
	RSD(%)	6.0	6.3	6.5	5.3		7.8
8330	Avg.	220	1,300	3.9	2,200	ND	3.5
	S(n-1)	9.57	0	0.14	0		0.48
	RSD(%)	4.4		3.6			13

Sample = W8-40-8 Compost Samples - Day 40 (units = $\mu\text{g/g}$)

<u>Method</u>		<u>HMX</u>	<u>RDX</u>	<u>TNB</u>	<u>TNT</u>	<u>2,6-DNT</u>	<u>2,4-DNT</u>
LW02	Avg.	2.0	2.3	0.44	2.4*	ND	ND
	S(n-1)	0.15	0.45	0.02	0.21		
	RSD(%)	7.5	20	4.1	8.7		
8330	Avg.	2.7	2.5	0.66	2.6	ND	ND
	S(n-1)	0.44	0.48	0.09	0.39		
	RSD(%)	16	19	14	15		

S = Standard Deviation.

RSD = Relative Standard Deviation.

* Average and S calculated from 3 determinations. One result rejected as significantly different on the basis of a Q-test. The Q-test is a statistical test that can be used to determine if a single experimental result in a series of replicate analysis can be rejected as a significantly different value. The following references provide more information on this procedure:

"Data Handling." From G.D. Christian, Analytical Chemistry, Third Edition. Copyright 1980, John Wiley and Sons, Inc.

R.B. Dean and W.J. Dixon, Anal. Chem., 23(1951), 636.

ND = Not Detected



Table 2

Paired t test

<u>Sample</u>	<u>HMX</u>	<u>RDX</u>	<u>TNB</u>	<u>TNT</u>	<u>2,6-DNT</u>	<u>2,4-DNT</u>
W8-1-8—Day 1	Y	NA	N	NA	NA	N
W8-400-8—Day 40	Y	Y	N	Y	NA	NA

NA = Test was not applied because there was no standard deviation obtained with the 8330 analysis.

Y = No statistical difference in the results by the two methods at the 99% confidence level.

N = A statistical difference in the results by the two methods at the 99% confidence level.